



MOTOROLA

Level 1-2 Service Manual

W208

Dual Band Wireless Telephone



W208
GSM 900/1800
GSM 850/1900

Table of Contents

Introduction	3
Product Identification	3
Product Names	3
Product Changes	3
Regulatory Agency Compliance	3
Computer Program Copyrights	4
About This Service Manual	4
Warranty Service Policy	5
Parts Replacement	6
Specifications	7
Product Overview	9
Features	9
General Functions	11
Controls, Indicators, and Input/Output (I/O) Connectors	11
User Interface Menu Structure	13
Battery Function	14
Operation	14
Tools and Test Equipment	14
Disassembly	15
Removing and Replacing the Battery	16
Removing and Replacing the SIM Card	17
Removing and Replacing the Front Housing	17
Removing and Replacing the Transceiver Board, Back Housing, and Vibrator Module	20
Removing and Replacing the Antenna Module, Microphone	21
Removing and Replacing the LCD Screen	22
Removing and Replacing the LCD Shielding Case	23
Subscriber Identity Module (SIM) and Identification Label	24
SIM	24
Identification	24
Troubleshooting	26
Manual Test Mode	26
Manual Test Mode Commands	26
Troubleshooting Chart	27
Programming: Software Upgrade and Flexing	28
Part Number Charts	29
Exploded View Diagram	29
Exploded View Parts List	30
Accessories	31
Index	1

Introduction

Motorola® Inc. maintains a worldwide organization that is dedicated to provide responsive, full-service customer support. Motorola products are serviced by an international network of company-operated product care centers as well as authorized independent service firms.

Available on a contract basis, Motorola Inc. offers comprehensive maintenance and installation programs that enable customers to meet requirements for reliable, continuous communications. To learn more about the wide range of Motorola service programs, contact your local Motorola products representative or the nearest Customer Service Manager.

Product Identification

The model number on a label (usually on the housing) identifies Motorola products. Use the entire model number when inquiring about the product. Numbers are also assigned to chassis and kits.

Use these numbers when requesting information or ordering replacement parts.

Product Names

Product names are listed on the front cover. Product names are subject to change without notice. Some product names, as well as some frequency bands, are available only in certain markets.

Product Changes

When electrical, mechanical or production changes are incorporated into Motorola products, a revision letter is assigned to the chassis or kit affected, for example: -A, -B, or -C, and so on. The chassis or kit number, complete with revision number is imprinted during production. The revision letter is an integral part of the chassis or kit number and is also listed on schematic diagrams, and printed circuit board layouts.

Regulatory Agency Compliance

This device complies with Part 15 of the FCC Rules. Operation is subject to the following conditions:

- This device may not cause any harmful interference, and
- this device must accept interference received, including interference that may cause undesired operation

This class B device also complies with all requirements of the Canadian Interference-Causing Equipment Regulations (ICES-003).

Cet appareil numérique de la classe B respecte toutes les exigences du Règlement sur le matériel brouilleur du Canada.

Computer Program Copyrights

The Motorola products described in this manual may include Motorola computer programs stored in semiconductor memories or other media that are copyrighted with all rights reserved worldwide to Motorola. Laws in the United States and other countries preserve for Motorola, Inc. certain exclusive rights to the copyrighted Introduction computer programs, including the exclusive right to copy, reproduce, modify, decompile, disassemble, and reverse-engineer the Motorola computer programs in any manner or form without Motorola's prior written consent. Furthermore, the purchase of Motorola products shall not be deemed to grant either directly or by implication, estoppel, or otherwise, any license or rights under the copyrights, patents, or patent applications of Motorola, except for a nonexclusive license to use the Motorola product and the Motorola computer programs with the Motorola product.

About This Service Manual

Using this service manual and the suggestions contained in it assures proper installation, operation, and maintenance of W208 telephones. Refer questions about this manual to the nearest Customer Service Manager. This manual contains mechanical service information required for the equipment described and is current as of the printing date.

Audience

This document aids service personnel in testing and repairing W208 telephones. Service personnel should be familiar with electronic assembly, testing, and troubleshooting methods, and with the operation and use of associated test equipment.

Scope

This manual provides basic information relating to W208 telephones, and also provides procedures and processes for repairing the units at Level 1 and 2 service centers, including:

- Unit swap out
- Repairing of mechanical faults
- Basic modular troubleshooting
- Testing and verification of unit functionality
- Initiate warranty claims and send faulty modules to Level 3 or 4 repair centers.

Conventions

Special characters and typefaces, listed and described below, are used in this publication to emphasize certain types of information.



Note: Emphasizes additional information pertinent to the subject matter.



Caution: Emphasizes information about actions that may result in equipment damage.



Warning: Emphasizes information about actions that may result in personal injury.



Keys to be pressed are represented graphically. For example, instead of "Press the Menu Key", you will see "Press .

Information from a screen is shown in text as similar as possible to what appears in the display. For example, ALERTS or ALERTS.

Information that you need to type is printed in **boldface type**.

Warranty Service Policy

The product is sold with the standard 12-month warranty terms and conditions. Accidental damage, misuse, and extended warranties offered by retailers are not supported under warranty.

Non-warranty repairs are available at agreed fixed repair prices.

Out of Box Failure Policy

The standard out of box failure criteria applies. Customer phones that fail very early on after the date of sale are to be returned to Manufacturing for root cause analysis, to guard against epidemic criteria. Manufacturing to bear the costs of early life failure.

Product Support

The customer's original phones will be repaired but not refurbished as standard. Appointed Motorola Service Hubs will perform warranty and non-warranty field service for level 2 (assemblies) and level 3 (limited Transceiver component). Motorola High Tech Centers will perform level 4 (full component) repairs.

Customer Support

Customer support is available through dedicated Call Centers and in-country help desks. Product-Service training should be arranged through the local Motorola Support Center.

Parts Replacement

When ordering replacement parts or equipment, include the Motorola part number and description used in the service manual. When the Motorola part number of a component is not known, use the product model number or other related major assembly along with a description of the related major assembly and of the component in question. In the U.S.A., to contact Motorola, Inc. on your TTY, call: 800-793-7834

Accessories and Aftermarket Division (AAD)

Replacement parts, test equipment, and manuals can be ordered from AAD.

U.S.A.

Phone: 800-422-4210

FAX: 800-622-6210

Outside U.S.A.

Phone: 847-538-8023

FAX: 847-576-3023

For EMEA spare parts call +49 461 803 1638.

For Asia spare parts call +65 648 62995.

Specifications

General Functions	Specification
Dimensions	108mm x 44mm x 14.9mm
Weight	78grams (with battery)
LCD Display	65K Color TFT, Active Area: 27.264mm x 27.264mm, Hardware pixels: 128 x 128
Band	GSM900/1800 or GSM850/PCS1900
Battery	850 mAh Li Ion Battery
Product type	BAR type
Antenna	Internal Antenna
Frequency Range (EGSM)	880-915 MHz Tx, 925-960 MHz Rx
Frequency Range (DCS)	1710 – 1785 MHz Tx, 1805-1880 MHz Rx
Frequency Range (GSM850)	824-849 MHz Tx, 869-894 MHz Rx
Frequency Range (PCS)	1850-1910MHz Tx, 1930-1990 MHz Rx
Channel Spacing	200KHz
Channels	174 EGSM, 374 DCS, 124 GSM850, 299 PCS
Modulation	GMSK at BT=0.3
Transmitter Phase Accuracy	5 Degrees RMS, 20 Degrees peak
Duplex spacing	45MHz EGSM, 95MHz DCS, 45MHz GSM850, 80MHz PCS
Frequency Stability	±0.1PPM of the downlink frequency (Rx)
Operating voltage	3.53V ~4.2V
Average Transmit Current	Power Level 5: 280 mA Power Level 19: 115 mA
Average Standby Current	DRX 2: 6 mA DRX 9: 2.7 mA
Temperature Range	-20°C to 55°C
Battery Life	Talk Time: 238-469 Mins; Stand by Time: 133~307 Hours
Battery Charge Time	4 Hours to 90% of 850mAH capacity
Alert Volume	Max 95dB@ 5cm, 0.5 watts input

Transmitter Functions	Specification
RF Power Output	33 dBm typical GSM850/GSM900 30 dBm typical DCS1800/PCS1900
Output Impedance	50 ohms nominal
Spurious Emissions	-36 dBm from 0.1 to 1GHz, -30 dBm from 1 to 4 GHz

Receiver Functions	Specification
Receiver Sensitivity	-107 dBm typical GSM 850/GSM900 -107 dBm typical DCS1800/PCS1900
RX Bit Error Rate (100K bits) type II	<2%
Channel Hop Time	500 microseconds
Time to Camp	Approximately 6~10 Second

Speech Coding Functions	Specification
Speech Coding Type	Regular pulse excitation/linear predictive coding with long term prediction (PRE LPC with LTP)
Bit Rate	13.0 Kbps
Frame Duration	20 ms
Block Length	260 bits
Classes	Class 1 bits =182 bits; Class 2 bits = 78 bits
Bit Rate with FEC Encoding	22.8 Kbps

Product Overview

The Motorola W208 features a global system for mobile communications wireless interface technology. It also features a simplified icon and graphical user interface (UI) for easier operation in addition to short message service text messaging (SMS), speed dialing, quick dialing, an alarm, a calculator, games, and an address book.

The telephones are made of polycarbonate plastic. The display and speaker, as well as the 21-key keypad, transceiver printed circuit board (PCB), microphone, charger and headphone connectors, and power button are contained within clam shell form-factor housing. The User-replaceable 850 mAh Lithium-Ion (Li-Ion) battery provide up to 238-469 Mins of talk time with up to 133-307 Hours of standby time. The userreplaceable 920 mAh Lithium-Ion (Li-Ion) battery provides up to 450 minutes of talk time with up to 350 hours of standby time. The phone accepts 1.8V/3V mini subscriber identity module (SIM) cards that fit into the SIM holder next to the battery. These telephones feature a 128 x 128 pixel color graphics display and an internal antenna.

Features

W208 telephones use advanced, self-contained, sealed, custom integrated circuits to perform the complex functions required for GSM communication. Aside from the space and weight advantage, microcircuits enhance basic reliability, simplify maintenance, and provide a wide variety of operational functions.

Features available in this family of telephones include:

- A 128 x 128 pixel color graphics display
- Internal antenna
- Lower voltage technology that provides increased standby and talk times
- Extended GSM (EGSM) channels
- Display animation
- VibraCall® vibrating alert
- 5-Way navigation key
- SIM Toolkit™ Class 2 (STK) (Network, subscription and SIM card or service provider dependent feature. Not available in all areas.)
- Backlight
- Speed-, Quick- and One-Touch dialing
- Call Forwarding and Holding
- Customized Menus
- Personal management tools calculator with currency converter, and clock with date
- Other features

Caller Line Identification

Upon receipt of a call, the calling party's phone number is compared to the phone book. If the number matches a phone book entry, that name will be displayed. If there is no phone book entry, the incoming phone number will be displayed. In the event that no caller identification information is available, an incoming call message is displayed.

SIM Toolkit™ - Class 2

SIM Application Toolkit is a value-added service delivery mechanism that allows GSM operators to customize the services they offer their customers, from the occasional user who requests sports news and traffic alerts, to a high call time business user who receives stock alerts and checks flight times. Operators can now create their own value-added services menu quickly and easily in the phone.

The customized menu will appear as the first menu and may be updated over-the-air with new services when customers request them.

General Functions

Controls, Indicators, and Input/Output (I/O) Connectors

The W208 phone's controls are located on the front side of the device and on the keyboard as shown in below. Indicators icons are displayed on the LCD.

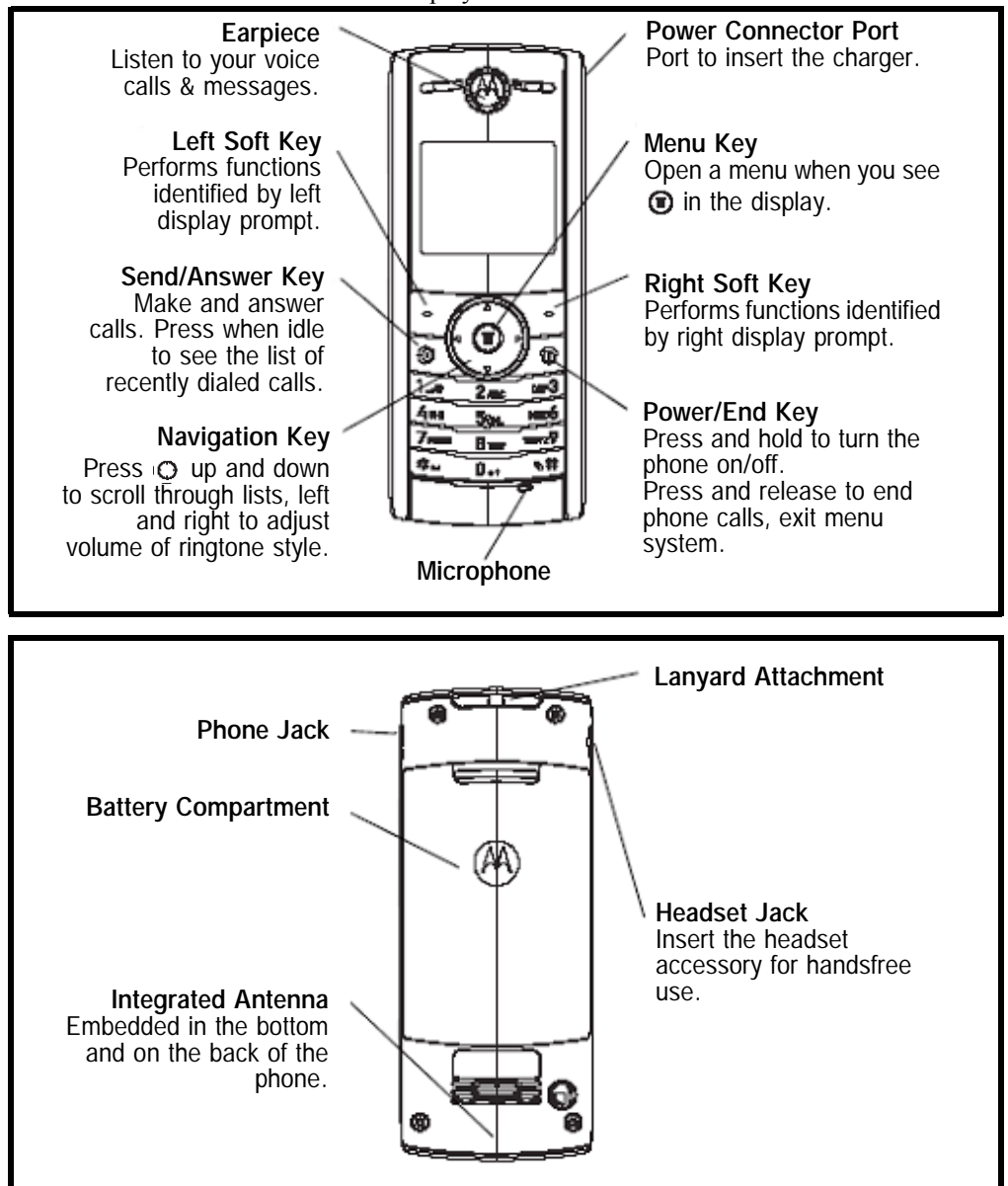

Figure 1. W208 Telephone Control Locations

Menu Navigation

W208 telephones are equipped with a simplified icon and graphical-based user interface. See the table below for details of the W208 menu structure. A five-way navigation key allows you to move easily through menus and confirm your selection.

Liquid Crystal Display (LCD)

The LCD provides a 700 square millimeter multicolor backlit color display with user-adjustable contrast settings for optimum readability in all light conditions. The bit-map 128 x 128 pixel display includes up to 3 lines of text, 1 line of icons, and 1 line of prompts.

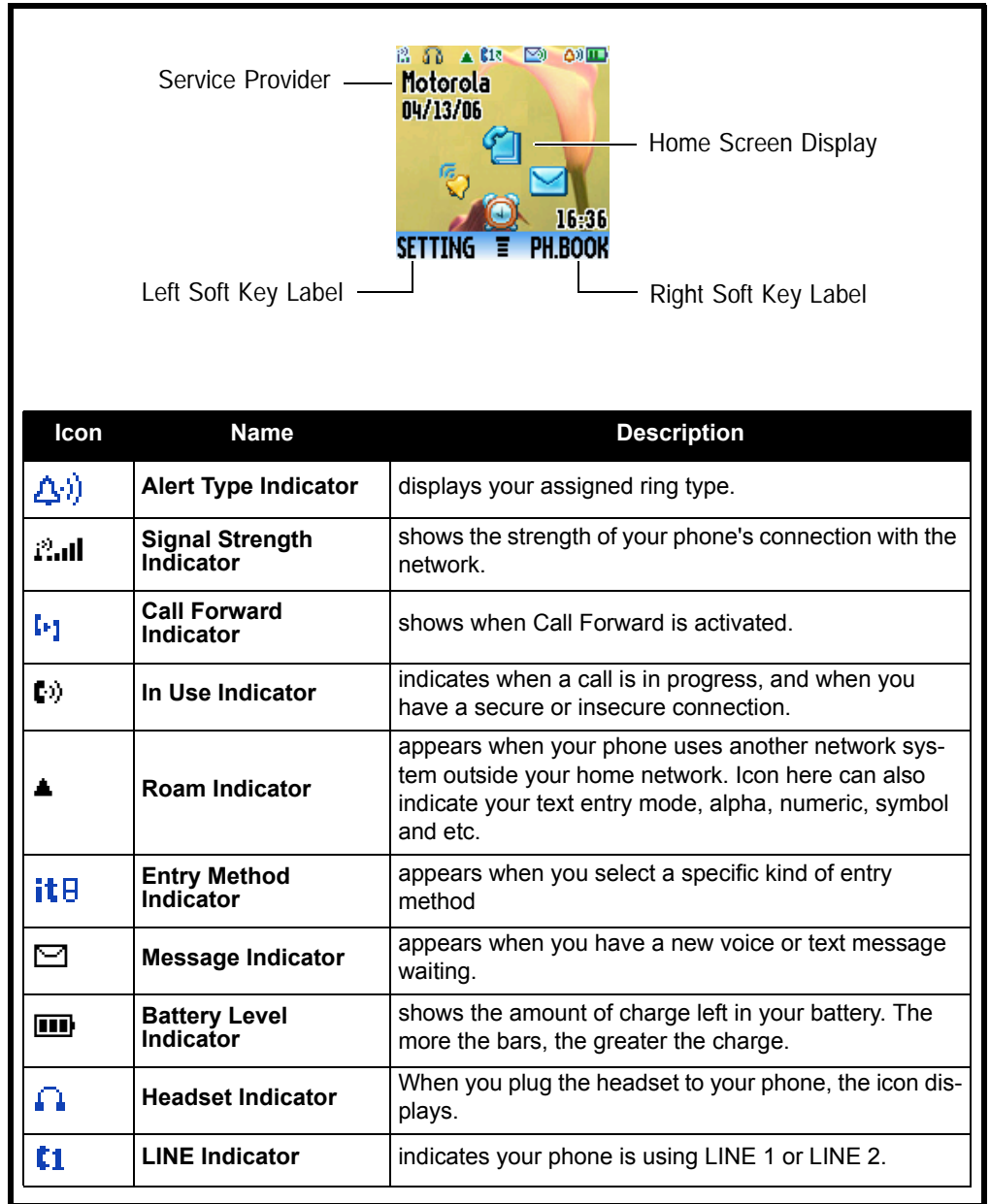











Figure 2. W208 Display Icon Indicators

User Interface Menu Structure

The table below shows a portion of the W208 telephone menu structure.

Menu Map

<p> Messages</p> <ul style="list-style-type: none">• Create message• Voicemail• Inbox• Info Services• Quick Notes• Outbox• Drafts <p> Phonebook</p> <p> Recent Calls</p> <ul style="list-style-type: none">• Received Calls• Dialed Calls• Notepad• Call times• Call Cost <p> Games</p> <ul style="list-style-type: none">• Rebels• Crazy• Football <p> FM Radio (Plug in earphones)</p> <p> Ring Style</p> <ul style="list-style-type: none">• Style• Loud Ring Detail• My tones	<p> Setting Menu</p> <ul style="list-style-type: none">• Call Forward• Phone Status• In-Call Setup• Security• Initial Setup• Network• Headset <p> Office Tools</p> <ul style="list-style-type: none">• Calculator• My menu• Alarm Clock• Datebook• Stop Watch• Lantern• Quick Dial• Fixed Dial• Service Dial <p> Personalize</p> <ul style="list-style-type: none">• Home Screen• Main Menu• Color Style• Greeting• Wallpaper• Screen Saver• Quick Dial
---	---

* Optional Network, SIM card, or subscription-dependent features.

Figure 3. W208 Menu Structure

Battery Function

The telephone displays a battery charge indicator icon in the idle screen to indicate the battery charge level. The gauge shows four levels: 100%, 66%, 33%, and Low Battery.

Removing the battery causes the phone to shut down immediately and lose any pending work (partially entered phone book entries or outgoing messages, for example).



Note: All batteries can cause property damage and/or bodily injury such as burns if a conductive material such as jewelry, keys, or beaded chains touches exposed terminals. The conductive material may complete an electrical circuit (short circuit) and become quite hot. Exercise care in handling any charged battery, particularly when placing it inside a pocket, purse, or other container with metal objects.



If the battery is removed while receiving a message, the message is lost.



To ensure proper memory retention, turn the phone OFF before removing the battery. Immediately replace the old battery with a fresh battery.

Operation

For detailed operating instructions, refer to the appropriate User Guide listed in the Related Publications section toward the end of this manual.

Tools and Test Equipment

The table below lists the tools and test equipment used on C139 telephones. Use either the listed items or equivalents.

Table 1: General Test Equipment and Tools

Motorola Part Number ¹	Description	Application
See Table 6	Charger	Used to charge battery and power phone
0180386A82	Antistatic Mat Kit (includes 66-80387A95 antistatic mat, 66-80334B36 ground cord, and 42-80385A59 wrist band)	Provides protection from damage to phone caused by electrostatic discharge (ESD)
-	Antistatic Gloves	Provides protection from damage to phone caused by electrostatic discharge (ESD)
8102430Z04	GSM / DCS / PCS Test SIM	Used to enable manual test mode
6680388B67	Disassembly tool, plastic with flat and pointed ends (manual opening tool)	Used during assembly/disassembly
6680388B01	Tweezers, plastic	Used during assembly/disassembly
-	T5 Screw driver	Used with Screw Driver
HP34401A ²	Digital Multimeter	Used to measure battery voltage

1. To order in North America, contact Motorola Aftermarket and Accessories Division (AAD) by phone at (800) 422-4210 or FAX (800) 622-6210. Internationally, AAD can be reached by calling (847) 538-8023 or by fax (847) 576-3023.
2. Not available from Motorola. To order, contact Hewlett Packard at (800) 452-4844.



Figure 4. A screwdriver (T5), a pair of tweezers, and a wedge tool

Disassembly

This section describes how to disassemble a W208 telephone. Tools and equipment used are listed on the preceding page.



Many of the integrated devices used in this phone are vulnerable to damage from electrostatic discharge (ESD). Ensure adequate static protection is in place when handling, shipping, and servicing any internal components.



Avoid stressing the plastic in any way to avoid damage to either the plastic or internal components.

Removing and Replacing the Battery



All batteries can cause property damage and/or bodily injury such as burns if a conductive material such as jewelry, keys, or beaded chains touches exposed terminals. The conductive material may complete an electrical circuit (short circuit) and become quite hot. Exercise care in handling any charged battery, particularly when placing it inside a pocket, purse, or other container with metal objects.

1. Ensure the phone is turned off.
2. Push the latch and pop out the battery cover.



Figure 5. Removing the battery cover

3. Press the tab to pop out the battery.



There is a danger of explosion if the Lithium ion battery is replaced incorrectly. Replace only with the same type of battery or equivalent as recommended by the battery manufacturer. Dispose of used batteries according to the manufacturer's instructions.

4. To replace, insert the battery with 2 tabs on its bottom end into the battery slot.



Figure 6. Replace the battery cover

5. Click the battery into place, then slip the battery cover over it.

Removing and Replacing the SIM Card

1. Remove the battery.
2. Remove the SIM from its holder by sliding it in the direction shown below.



Figure 7. Removing the SIM card

3. To replace, carefully slide the SIM into position in its socket.

Removing and Replacing the Front Housing

1. Remove the SIM card.
2. Remove six T5 screws around the rear housing.
3. Use torque force of 13.73 N-cm.



Figure 8. Removing the six T5 screws

-
4. Pull open the top of the front housing.



Figure 9.

5. Use a flat wedge tool to pry the case open along the central seam beginning in the higher left hand corner and sliding down and around to disengage the hooks. Repeat this for the right hand side.

➡ *Be careful not to damage the side rubbers.*



Figure 10. Prying the case apart along the seam

6. Remove the front housing.



Figure 11. Removing the front housing

7. (Optional) Remove and replace the rubber keypad. It slips out of the front housing.



Figure 12. Removing the rubber keypad

8. To replace, simply snap the front and back halves together again.

Removing and Replacing the Transceiver Board, Back Housing, and Vibrator Module

1. Remove the front housing.
2. Disengage the both side hooks which help to secure the transceiver board to the rear housing, and then pop it out.



Figure 13. Disengaging the side hooks

3. In the rear housing component, gently pry out the vibrator module.



Figure 14. Removing the vibrator module

Removing and Replacing the Antenna Module, Microphone

1. Remove the transceiver board, the vibrator module, and the rear housing.
2. Gently snap the antenna away from the transceiver board.

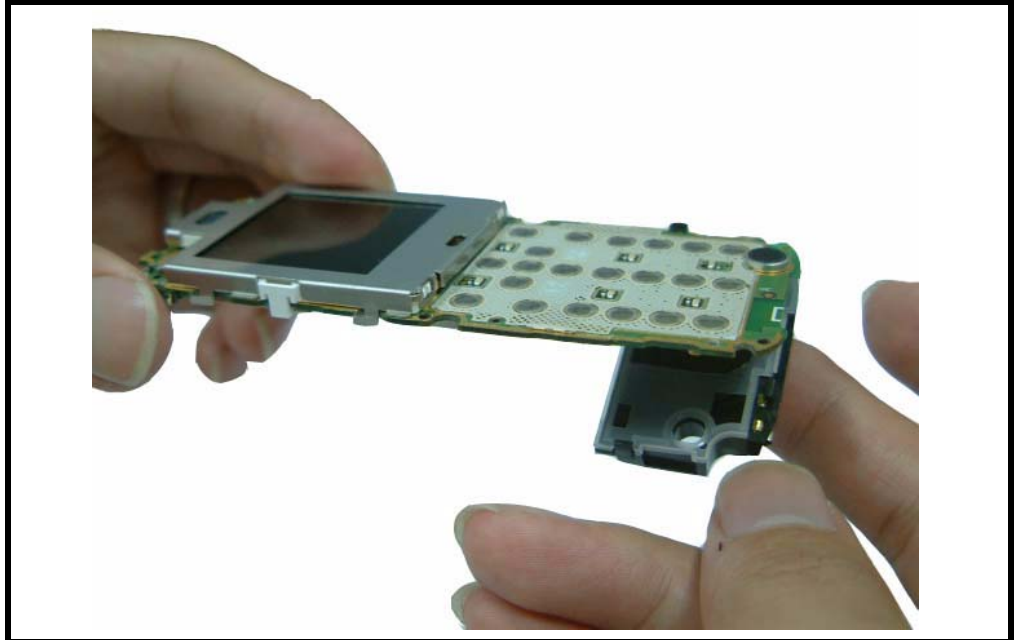

Figure 15. Removing the antenna module

3. (Optional) Remove and replace the speak.

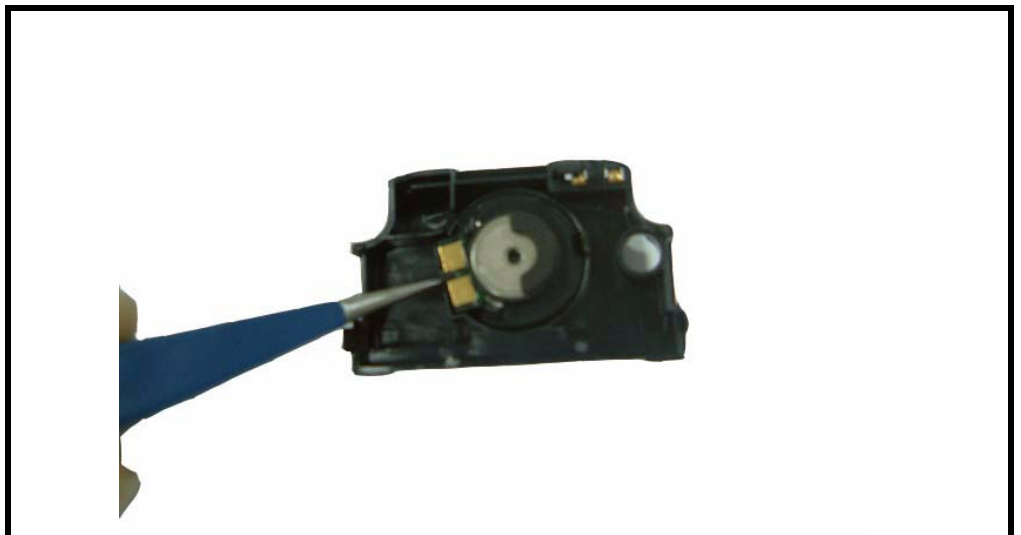

Figure 16. Removing the microphone

- Carefully pry off the microphone component.

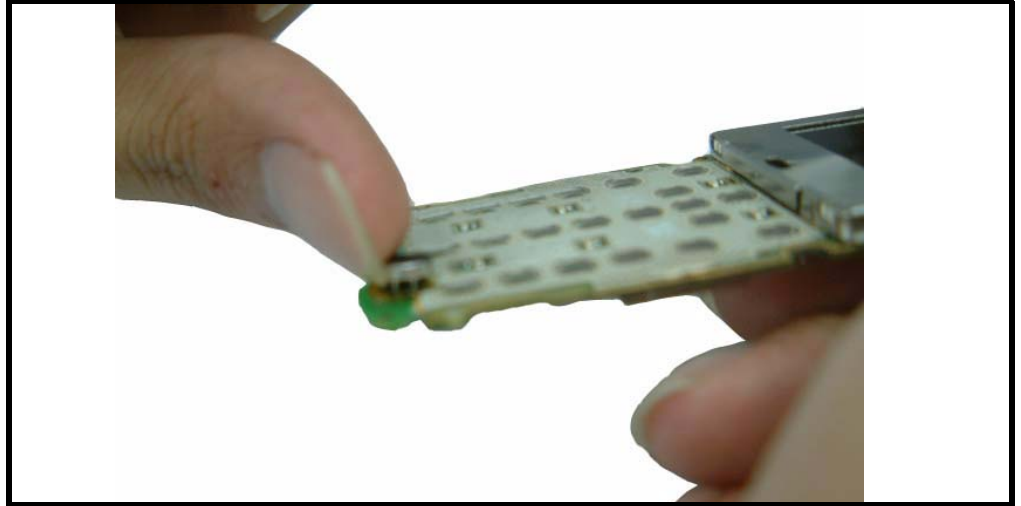

Figure 17. Removing the microphone

Removing and Replacing the LCD Screen

- Remove the antenna module as described earlier.
- Gently pry the LCD screen away from the Transceiver board. Six hooks hold it in place (three on each side).

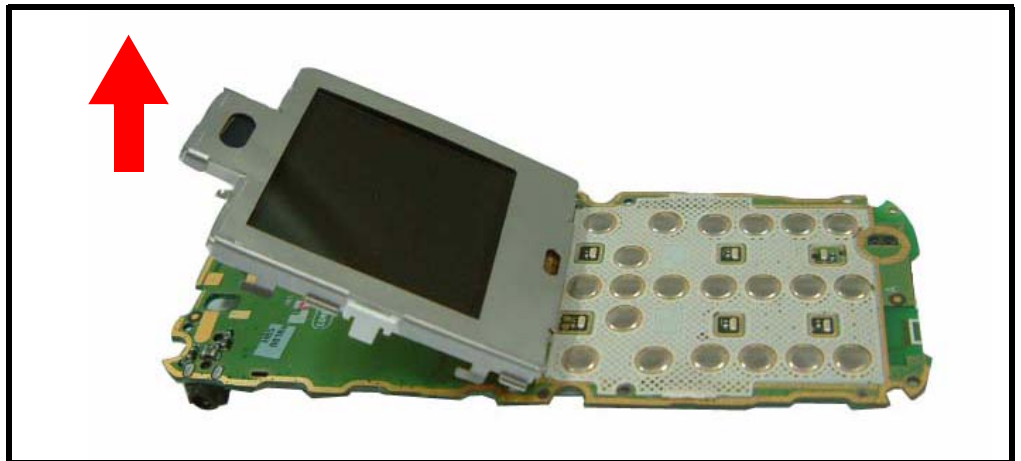

Figure 18. Pry the LCD screen away from the Transceiver board

- Detach the cable connecting the LCD screen to the Transceiver board.
- To replace it, gently solder the cable to the Transceiver board then mount the LCD.
- Restore the antenna module and other parts.

Removing and Replacing the LCD Shielding Case

1. Remove the LCD screen as described earlier.
2. Gently pry the LCD shielding case away from the LCD screen.

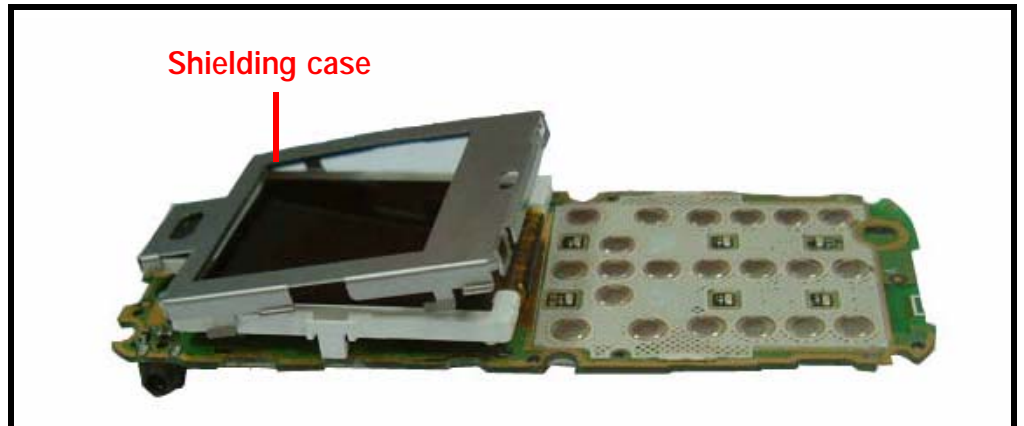

Figure 19. Pry the LCD shielding case away

3. (Optional) Remove and Replace the receiver.



Figure 20. Pop out the receiver

4. To replace it, mount the LCD shielding case over the LCD screen.
5. Restore the LCD screen and other parts.

Subscriber Identity Module (SIM) and Identification Label

SIM

A SIM is required to access the existing local GSM network, or remote networks when traveling (if a roaming agreement has been made with the provider).

The SIM contains:

- All the data necessary to access GSM services
- The ability to store user information such as phone numbers
- All information required by the network provider to provide access to the network

Identification

Each Motorola GSM phone is labeled with a variety of identifying numbers. The following information describes the current identifying labels.

Mechanical Serial Number (MSN)

- The MSN is an individual unit identity number and remains with the unit throughout its life.
- The MSN can be used to log and track a phone on Motorola's Service Center Database.
- The MSN is divided into 4 sections as shown in Figure 21.

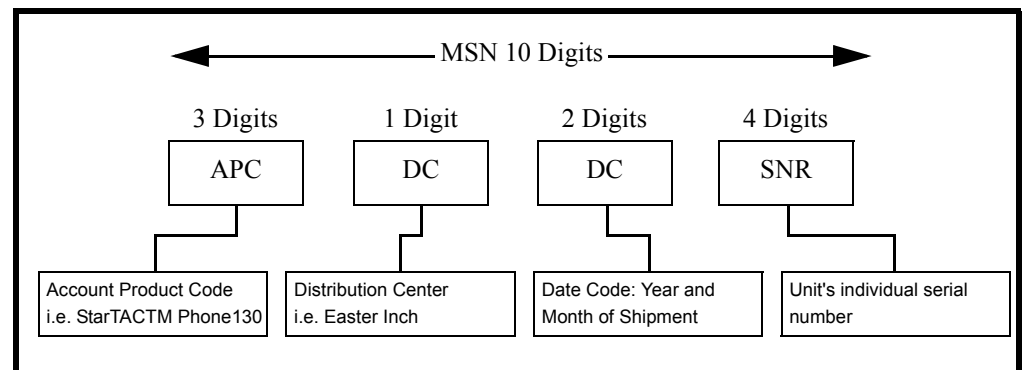

Figure 21. MSN Label Breakdown

International Mobile Station Equipment Identity (IMEI)

The International Mobile Station Equipment Identity (IMEI) number is an individual number unique to the Transceiver and is stored within the unit's memory. The IMEI uniquely identifies an individual mobile station and thereby provides a means for controlling access to GSM networks based on mobile station types or individual units. The full IMEI structure is listed in the table below.

Table 2: IMEI Number Breakdown

TAC	Serial Number	Check Digit
NNXXXXXX	ZZZZZZ	A

Where

TAC Type Allocation Code, formerly known as Type Approval Code

NN Reporting Body Identifier (BABT or CTIA)

XXXXXX Type Identifier (defined by BABT or CTIA)

ZZZZZZ Individual unit serial number

Phase 1 = 0.

A Phase 2 & 2+= check digit and is defined as a function of all other IMEI digits

Other label number configurations present are:



- **TRANSCIVER NUMBER:** Identifies the product type. Normally the SWF number. (i.e. V100).
- **PACKAGE NUMBER:** Identifies the equipment type, mode, and language in which the product is shipped.

Troubleshooting

Manual Test Mode

Motorola W208 telephones are equipped with a manual test mode capability. This allows service personnel to verify functionality and perform fault isolation by entering keypad commands.

To enter the manual test command mode, a GSM/DCS/PCS test SIM must be used.

1. Press and hold  to turn the phone OFF.
2. Remove the battery as described in the procedures.
3. Remove the customer's SIM card from the phone as described in the procedures.
4. Insert the test SIM into the SIM slot.
5. Replace the battery as described in the procedures.
6. Press and hold  to turn the phone ON.

Manual Test Mode Commands

Table 3: Manual Test Commands

Key Sequence	Test Function/Name	Remarks
#02#	Handset information	
#03#	RF information	
#04#	ADC information	
#09#	Simple Test mode	
**0102#	FFS format	
**0105#	Disable EFEM mode	
*#06#	IMEI number	

Troubleshooting Chart

Table 4: Level 1 and 2 Troubleshooting Chart

Symptom	Probable Cause	Verification and Remedy
1. Telephone will not turn on or stay on.	a) Battery either discharged or defective.	Measure battery voltage across a 50 ohm (>1 Watt) load. If the battery voltage is <3.25 Vdc, recharge the battery using the appropriate battery charger. If the battery will not recharge, replace the battery. If battery is not at fault, proceed to b.
	b) Battery terminals open or mis-aligned.	Visually inspect the battery terminals on both the battery and the telephone. Realign and, if necessary, either replace the battery or refer to a Level 3 Service Center for the battery connector replacement. If battery terminals are not at fault, proceed to c.
	c) keypad defective.	Replace the keypad. Temporarily connect a +3.6 Vdc supply to the battery terminals. Press and hold the PWR button. If unit turns on and stays on, disconnect the dc power source and reassemble with the new keypad.
2. Telephone exhibits poor reception or erratic operation such as calls frequently dropping or weak or distorted audio.	Connections to or from lower PCB defective.	Check connection between the antenna and the lower PCB.
3. Display is erratic, or provides partial or no display.	LCM defective.	Replace the LCM. Verify that the fault has been cleared and reassemble the unit with the new LCM.
4. Incoming call alert transducer audio distorted or volume is too low.	Speaker defective.	Replace the speaker as described in the procedures. Verify that the fault has been cleared and reassemble the unit with the new speaker.
5. Telephone transmit audio is weak. (usually indicated by called parties complaining of difficulty in hearing voice).	Microphone defective.	Replace the microphone as described in the procedures. Verify that the fault has been cleared and reassemble the unit with the new microphone.
6. Receive audio from earpiece speaker is weak or distorted.	a) Connections to or from lower PCB defective.	Check connection between the antenna and the lower PCB. If the connection is OK, proceed to b.
	b) Speaker defective.	Temporarily replace the speaker with a known good speaker. Ensure good connection. Place a call and verify improvement in earpiece audio. If fault is cleared, reassemble the telephone with the good speaker.

Table 4: Level 1 and 2 Troubleshooting Chart (Continued)

Symptom	Probable Cause	Verification and Remedy
7. Telephone will not recognize or accept SIM card.	SIM card defective.	Check the SIM card contacts for dirt. Clean if necessary, and check if fault has been cleared. If the contacts are clean, insert a known good SIM card into the telephone. Power up the unit and confirm that the card has been accepted. If the fault no longer exists, replace the defective SIM card.
8. Keypad not functioning.	Keypad defective.	Use alcohol to wipe the keypad metal dome. Check if fault has been cleared. If the fault is still present, either replace the keypad or refer to a Level 3 Service Center for the keypad metal dome replacement.
9. Vibrator feature not functioning.	a) Vibrator faulty.	Check general condition of vibrator. If it is good, proceed to b.
	b) Vibrator defective.	Replace the defective vibrator.
10. No or weak audio when using headset.	Headset plug not fully pushed.	Ensure the headset plug is fully seated in the jack.

Programming: Software Upgrade and Flexing

Contact your local technical support engineer for information about equipment and procedures for flashing and flexing.

Part Number Charts

The following section provides a reference for the parts associated with W208 telephones.

Exploded View Diagram

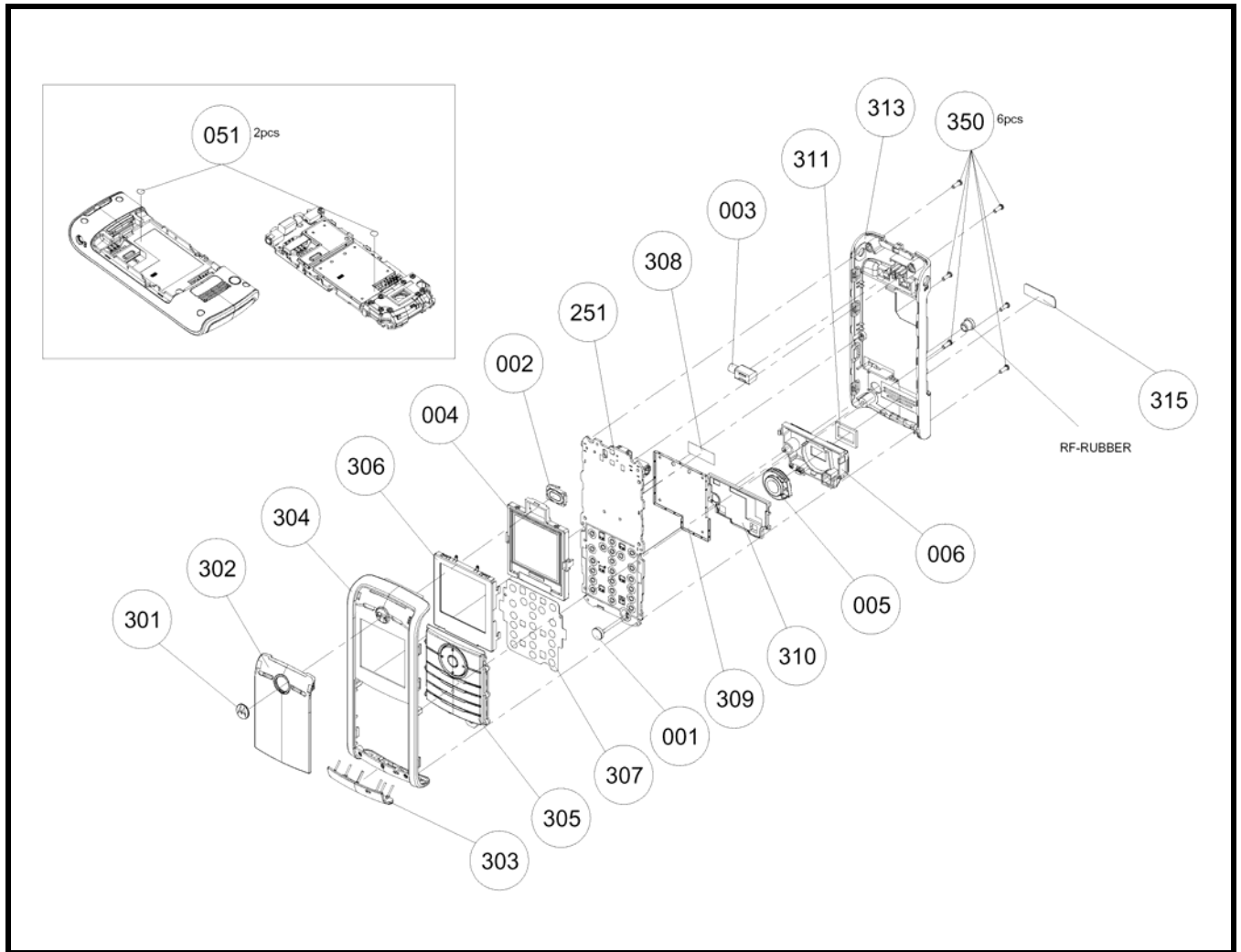

Figure 22. W208 Exploded View Diagram

Exploded View Parts List

Table 5: W208 Exploded View Parts List

Part Number	Item Number	Description	Specification
001	2220432301W	MIC	KUF4323-013031 ϕ 6*1.5 -41dB
002	2240071103W	RECEIVER	SDRP0711KJ01-F2-G AAC
003	3930408012W	SPR-VIB	ϕ 4*L8 1.3V LA4-459ED COPAL
004	7630001552W	LCM	TD015THEA6 128*128 65K TOPPOLY
005	2250160808W	SPEAKER	DMS1608F-05-PC-F1-G 8ohm AAC
006	2300H85001W	I-ANTENNA	H85 ANT+HOLDER EU
051	82E5803301W	LABEL	E58 WATERPROOF LABEL ϕ 4mm
251	6910830001W	F/WMB 33	H85 GA-107
300	5501390001W	ME/PT 33	H85/H85A RED
301	2545E58001W	MARK	E58-ABS CHROME M-LOGO
302	2541H85001W	LCD-LENS	H85-PC-BLACK
303	3028H85001W	RF-COV	H85-SILICON-BLACK
304	2511H85001W	UPP-ASSY	H85-RED
305	3101H85001W	DIAL-KEY	H85-RUBBER-BLACK-E-21KEY
306	3012H85001W	SHIELDASY	H85-LCD SHIELD+SPONGE ASSY
307	3109H85001W	MET-DOME	H85- ϕ 4*170g-21KEY
308	3064H85001W	MYLAR	H85-PC-6.5*16.65*0.055
309	3052H85003W	SHIELD-C	H85-SUS304-38.55*32.2*0.15T
310	3068H85001W	GASKET	H85-ANT-RUBBER
311	302FH85001W	SPK-GASKE	H85-PRON
313	2512H85001W	LOW-ASSY	H85-BLACK
315	3062H85001W	NAMEPLATE	H85-PC-GRAY
350	3501750102W	SCREW	TORX M1.7*5.0-BLACK-NI KL



There is a danger of explosion if the Lithium ion battery pack is replaced incorrectly. Replace only with the same type of battery or equivalent as recommended by the battery manufacturer. Dispose of used batteries according to the manufacturer's instructions.

To order parts please use the following Link:

<https://servicelink3.motorola.com>

(Password is required)

For information on ordering parts please contact EMEA at +49 461 803 1638.

Accessories

Table 6: List of Accessories

Description	Part Number
Power Solutions	
BQ50 battery 850 mAh	SNN5804A
BT50 battery 850 mAh	SNN5771A
EMU Switch Mode Midrate (PRC)	SPN5188B
EMU Switch Mode Midrate (US)	SPN5185B
EMU Switch Mode Midrate (Taiwan)	SPN5216C
EMU Switch Mode Midrate (Euro)	SPN5189B
EMU Switch Mode Midrate (HK/UK)	SPN5190B
EMU Switch Mode Midrate (Australia)	SPN5193B
EMU Switch Mode Midrate (India)	SPN5194B
EMU Switch Mode Midrate (Mexico)	SPN5186B
EMU Switch Mode Midrate (Brazil)	SPN5187B
EMU Switch Mode Midrate (Arg)	SPN5192B
EMU Switch Mode Dual Rate (Brazil)	SPN5196B
EMU Switch Mode Dual Rate (Arg)	SPN5197B
EMU Switch Mode Dual Rate (PRC)	SPN5198B
EMU Switch Mode Dual Rate (HK)	SPN5199B
EMU Switch Mode Dual Rate (Mex)	SPN5200B
EMU Switch Mode Dual Rate (US)	SPN5202B
EMU Switch Mode Dual Rate (Twn)	SPN5270B
In-Vehicle	
VC700 EMU Power Adapter	SYN0847A
Audio&Connectivity	
Mini USB/USB/Serial Data Cable	SKN6371B/C
Mono Earbud Headset (Black)	SYN8390B
Mono Earbud Headset (Silver)	AAYN4264B
One-Touch Headset	SYN8419C
Stereo One-Touch Earbud Headset	CHYN4516B
Stereo One-Touch Earbud Headset	SYN1603B
Right-Angle Adapter	SKN6182A
Audio Converter	SKN6183A
Consumer&Personalization	
Silver Lanyard (Asia except PRC)	AAYN4402A
Silver Lanyard	CHYN4546

Index

A

About

- Audience 4
- Conventions 5
- Scope 4

Accessories and Aftermarket Division 6

Alert Type Indicator 12

Audience 4

B

Back Housing

- Removing and Replacing 20

Battery

- Disposal 16
- Function 14
- Operation 14
- Removing and Replacing 16

Battery Gauge 14

Battery Level Indicator 12

C

Call Forward Indicator 12

Caller Line Identification 10

Controls 11

Conventions 5

Customer Support 5

D

Disassembly 15

E

Electrostatic Discharge 15

Entry Method Indicator 12

F

Front Housing

- Removing and Replacing 17

G

General Functions 11

H

Headset Connector Port 11
Headset Indicator 12

I

In Use Indicator 12
Indicators 11
Input/Output (I/O) Connectors 11
International Mobile Station Equipment Identity (IMEI) 24
 Number Breakdown 24

L

LCD Shielding Case
 Removing and Replacing 23
Left Soft Key 11
LINE Indicator 12
Liquid Crystal Display (LCD) 12
 LCD Shielding Case 23
 Removing and Replacing 22
Low Battery 14

M

Mechanical Serial Number 24
Menu Key 11
Menu Navigation 11
Message Indicator 12
Microphone 11

N

Navigation Key 11

O

Out of Box Failure Policy 5

P

Part Number Charts 29
Parts Replacement 6
 Accessories and Aftermarket Division 6
Power Connector Port 11
Power/End Key 11
Product Overview 9
 Caller Line Identification 10
 Features 9
 SIM Toolkit™ - Class 2 10
Product Support 5

R

Right Soft Key 11
Roam Indicator 12

S

Scope 4
Send/Answer Key 11
Signal Strength Indicator 12
SIM Card 24
 Identification Label 24
 International Mobile Station Equipment Identity (IMEI) 24
 Mechanical Serial Number 24
 Removing and Replacing 17
SIM Toolkit™ - Class 2 10
Specifications 7

T

Tools and Test Equipment 14
Troubleshooting 26

U

USB Connector Port 11
User Interface Menu Structure 13

V

Vibrator Motor
 Removing and Replacing 21

W

Warranty Service Policy 5
 Customer Support 5
 Out of Box Failure Policy 5
 Product Support 5

MOTOROLA, the Stylized M Logo, and all other trademarks indicated as such herein are trademarks of Motorola, Inc.

All other product or service names are the property of their respective owners.

® Reg. U.S. Pat. & Tm. Off.

© 2005 Motorola, Inc.

All rights reserved.

Personal Communications Sector,
Sawgrass International Concourse
789 International Parkway Room S2C
Sunrise, FL 33323