

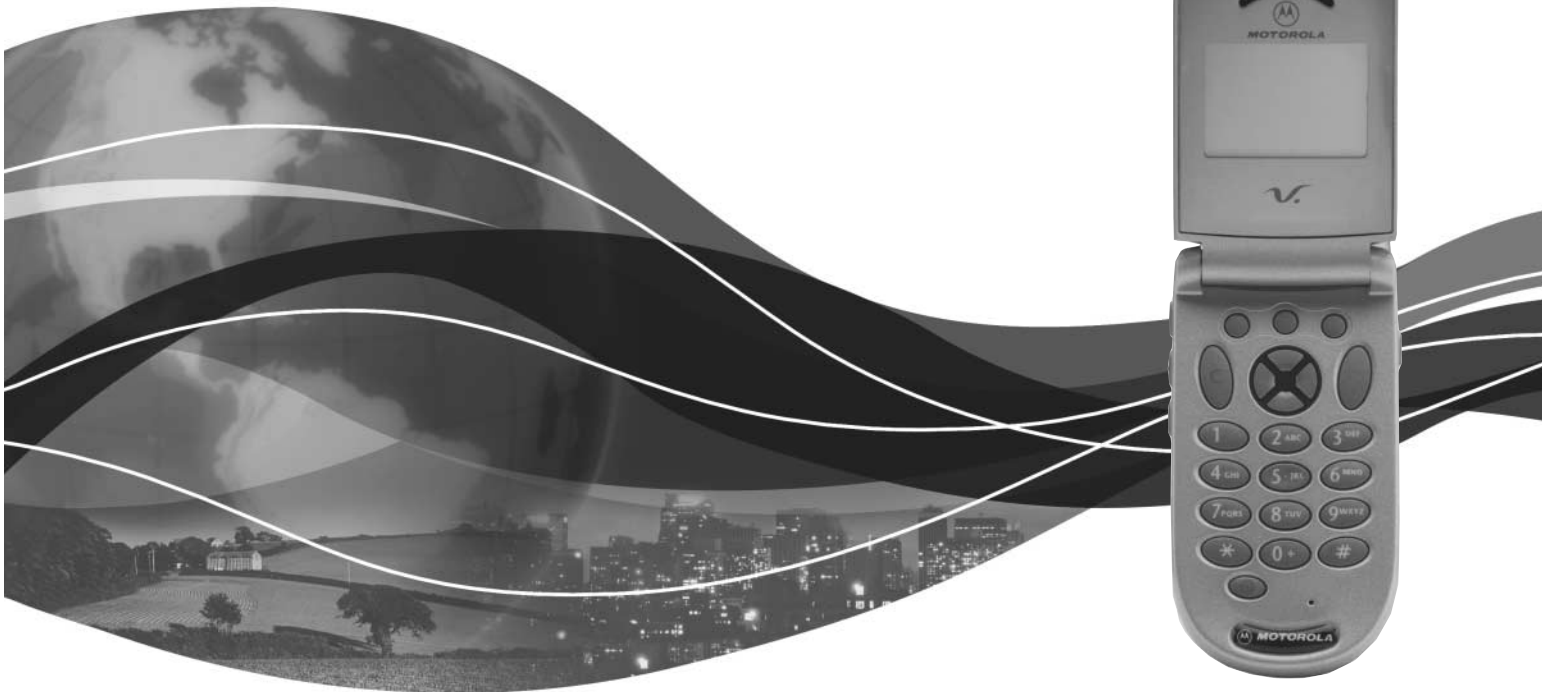

Level III Service Manual

# Product Family B89

## Tri-Band Mobile Telephone



V.Series™ 66  
GSM 900/1800/1900 MHz & GPRS Technologies



# Table of Contents

<b>Introduction</b> .....	<b>1</b>
Product Identification .....	1
Product Names .....	1
Product Changes .....	1
Regulatory Agency Compliance .....	1
Computer Program Copyrights .....	2
About This Service Manual .....	2
Warranty Service Policy .....	3
<b>Specifications</b> .....	<b>5</b>
<b>Product Overview</b> .....	<b>6</b>
Features .....	6
<b>General Operation</b> .....	<b>9</b>
Controls, Indicators, and Input / Output (I/O) Connections .....	9
User Interface Menu Structure .....	12
Alert Settings .....	12
Battery Function .....	13
Operation .....	13
<b>Tools and Test Equipment</b> .....	<b>15</b>
<b>Disassembly</b> .....	<b>16</b>
Removing and Replacing the Battery .....	16
Removing and Replacing the Subscriber Identity Module (SIM) .....	17
Removing and Replacing the Antenna .....	19
Removing and Replacing the Light Guide .....	20
Removing and Replacing the Rear Housing .....	20
Removing and Replacing the Transceiver Board Assembly .....	22
Removing and Replacing the Keypad PCB .....	24
Removing and Replacing the Microphone Assembly .....	25
Removing and Replacing the Keypad .....	26
Removing and Replacing the Lens Assembly .....	26
Removing and Replacing the Real Time Clock (RTC) Battery .....	28
Removing and Replacing the Display Board Assembly .....	29
Removing and Replacing the LCD Module .....	31
Removing and Replacing the Flip Housing .....	33
Removing and Replacing the Flex Assembly .....	35
<b>SIM Cards and Identification</b> .....	<b>37</b>
SIM Card .....	37
Personality Transfer .....	37
Identification .....	37
<b>Troubleshooting</b> .....	<b>39</b>
Manual Test Mode .....	39
Manual Test Mode Commands .....	39
Troubleshooting Chart .....	41
Programming: Software Upgrade and Flexing .....	44

---

<b>Part Number Charts</b> .....	<b>45</b>
Related Publications .....	45
Exploded View Diagram .....	46
Exploded View Parts List .....	47
Model-dependent Part Numbers .....	48
Accessories .....	48
<b>Index</b> .....	<b>Index-1</b>

## Introduction

Motorola® Inc. maintains a worldwide organization that is dedicated to provide responsive, full-service customer support. Motorola products are serviced by an international network of company-operated product care centers as well as authorized independent service firms.

Available on a contract basis, Motorola Inc. offers comprehensive maintenance and installation programs which enable customers to meet requirements for reliable, continuous communications.

To learn more about the wide range of Motorola service programs, contact your local Motorola products representative or the nearest Customer Service Manager.

## Product Identification

Motorola products are identified by the model number on the housing. Use the entire model number when inquiring about the product. Numbers are also assigned to chassis and kits. Use these numbers when requesting information or ordering replacement parts.

## Product Names

Product names included in Product Family B89 (PF B89) telephones are listed on the front cover. Product names are subject to change without notice. Some product names, as well as some frequency bands, are available only in certain markets.

## Product Changes

When electrical, mechanical or production changes are incorporated into Motorola products, a revision letter is assigned to the chassis or kit affected, for example; -A, -B, or -C, and so on.

The chassis or kit number, complete with revision number is imprinted during production. The revision letter is an integral part of the chassis or kit number and is also listed on schematic diagrams and printed circuit board layouts.

## Regulatory Agency Compliance

This device complies with Part 15 of the FCC Rules. Operation is subject to the following conditions:

1. This device may not cause any harmful interference, and
2. this device must accept interference received, including interference that may cause undesired operation.

This class B device also complies with all requirements of the Canadian Interference-Causing Equipment Regulations (ICES-003).

Cet appareil numérique de la classe B respecte toutes les exigences du Règlement sur le matériel brouilleur du Canada.

---

## Computer Program Copyrights

The Motorola products described in this manual may include Motorola computer programs stored in semiconductor memories or other media that are copyrighted with all rights reserved worldwide to Motorola. Laws in the United States and other countries preserve for Motorola, Inc. certain exclusive rights to the copyrighted computer programs, including the exclusive right to copy, reproduce, modify, decompile, disassemble, and reverse-engineer the Motorola computer programs in any manner or form without Motorola's prior written consent. Furthermore, the purchase of Motorola products shall not be deemed to grant either directly or by implication, estoppel, or otherwise, any license or rights under the copyrights, patents, or patent applications of Motorola, except for a nonexclusive license to use the Motorola product and the Motorola computer programs with the Motorola product.

## About This Service Manual

Using this service manual and the suggestions contained in it assures proper installation, operation, and maintenance of PF B89 telephones. Refer questions about this manual to the nearest Customer Service Manager.

A product family is the group of products having the same account product code (APC). To locate the APC on a device, refer to "Mechanical Serial Number (MSN)" later in this manual.

### Audience

This document aids service personnel in testing and repairing PF B89 telephones. Service personnel should be familiar with electronic assembly, testing, and troubleshooting methods, and with the operation and use of associated test equipment.

Use of this document assures proper installation, operation, and maintenance of Motorola products and equipment. It contains all service information required for the equipment described and is current as of the printing date.

### Scope

The scope of this document is to provide the reader with basic information relating to PF B89 telephones, and also to provide procedures and processes for repairing the units at Level 1 and 2 service centers including:

- Unit swap out
- Repairing of mechanical faults
- Basic modular troubleshooting
- Testing and verification of unit functionality
- Initiate warranty claims and send faulty modules to Level 3 or 4 repair centers.

---

## Conventions

Special characters and typefaces, listed and described below, are used in this publication to emphasize certain types of information.



*Note: Emphasizes additional information pertinent to the subject matter.*



*Caution: Emphasizes information about actions which may result in equipment damage.*



*Warning: Emphasizes information about actions which may result in personal injury.*



Keys to be pressed are represented graphically. For example, instead of "Press the Enter Key", you will see "Press ".

Information from a screen is shown in text as similar as possible to what appears in the display. For example, **ALERTS** or **ALERTS** or **ALERTS**.

Information that you need to type is printed in **boldface type**

## Revisions

Any changes that occur after manuals are printed are described in publication revision bulletins (PMRs). These bulletins provide change information that can include new parts listing data, schematic diagrams, and printed board layouts.

## Warranty Service Policy

The product will be sold with the standard 12 months warranty terms and conditions. Accidental damage, misuse, and extended warranties offered by retailers are not supported under warranty. Non warranty repairs are available at agreed fixed repair prices.

### Out of Box Failure Policy

The standard out of box failure criteria applies. Customer units that fail very early on after the date of sale, are to be returned to Manufacturing for root cause analysis, to guard against epidemic criteria. Manufacturing to bear the costs of early life failure.

### Product Support

Customer's original units will be repaired but not refurbished as standard. Appointed Motorola Service Hubs will perform warranty and non-warranty field service for level 2 (assemblies) and level 3 (limited PCB component). The Motorola HTC centers will perform level 4 (full component) repairs.

**Customer Support**

Customer support is available through dedicated Call Centers and in-country help desks. Product Service training should be arranged through the local Motorola Support Center.

**Ordering Replacement Parts**

Only centers authorized to carry out repairs can purchase spare parts. Orders for spare parts from hubs and Hi-Tech Centers should be placed with the regional Motorola Parts Distribution Center.



## Specifications

General Function	Specification
Frequency Range GSM	880-915 MHz Tx (with EGSM) 925-960 MHz Rx
Frequency Range DCS	1710-1785 MHz Tx 1805-1880 MHz Rx
Frequency Range PCS	1850.2-1909.8 MHz Tx 1930.2-1989.8 MHz Rx
Channel Spacing	200 kHz
Channels	174 EGSM, 374 DCS, 274 PCS carriers with 8 ch. per carrier
Modulation	GMSK at BT = 0.3
Transmitter Phase Accuracy	5 Degrees RMS, 20 Degrees peak
Duplex Spacing	45 MHz GSM, 95 MHz DCS, 80 MHz PCS
Frequency Stability	± 0.10 ppm of the downlink frequency (Rx)
Operating Voltage	+3.0V dc to +5.1V dc (battery) +4.4V dc to +6.5V dc (external connector)
Transmit Current	Typically 250 mA average
Stand-by Current	Typically 7.5 mA (DRX2), 3.75 mA (DXR9)
Dimensions, with 500 mAh LI Ion batt	82 mm x 43 mm x 26 mm (3.2 inches X 1.7 inches X 1.0 inches)
Dimensions, with 1000 mAh LI Ion batt	82 mm x 43 mm x 26 mm (3.2 inches X 1.7 inches X 1.0 inches)
Size (Volume)	65 cc (3.9 in <sup>3</sup> ), with 500 mAh battery 81 cc (4.8 in <sup>3</sup> ), with 1000 mAh battery
Weight	79 gm (2.8 oz), with 500 mAh battery 101 gm (3.5 oz), with 1000 mAh battery
Temperature Range	-10° C to +55° C (+15° F to +130° F)
Battery Life, 500 mAh LI Ion Battery	Talk Time 120 to 180 minutes Standby 50 to 125 hours
Battery Life, 1000 mAh LI Ion Battery	Talk Time 240 to 330 minutes Standby 100 to 250 hours

Transmitter Function	Specification
RF Power Output	32.5 dBm nominal GSM, 29.5 dBm nominal DCS / PCS
Output Impedance	50 ohms nominal
Spurious Emissions	-36 dBm from 0.1 to 1 GHz, -30 dBm from 1 to 4 GHz

Receiver Function	Specification
Receive Sensitivity	-107 dBm GSM, -105 dBm DCS / PCS
RX bit error rate (100k bits) Type II	< 2%
Channel Hop Time	500 microseconds
Time to Camp	Approximately 5-10 seconds

Speech Coding Function	Specification
Speech Coding Type	Regular pulse excitation / linear predictive coding with long term prediction (RPE LPC with LTP)
Bit Rate	13.0 kbps
Frame Duration	20 ms
Block Length	260 bits
Classes	Class 1 bits = 182 bits; Class 2 bits = 78 bits
Bit Rate with FEC Encoding	22.8 kbps

---

## Product Overview

Motorola PF B89 telephones are the smallest and lightest global system for mobile communications (GSM) general packet radio service (GPRS) wireless application protocol (WAP)-enabled mobile phones currently available. The PF B89 incorporates a new user interface (UI) for easier operation, allows short message service (SMS) text messaging, and includes personal information manager (PIM) functionality. It is a tri-band phone that allows roaming within the GSM 900 MHz, digital cellular system (DCS) 1800 MHz, and personal communications services (PCS) 1900 MHz bands.

PF B89 telephones support GPRS and SMS in addition to traditional circuit switched transport technologies. GPRS, where available, provides substantial increases in mobile data communications performance and the efficient use of radio spectrum. Data transmission rates for GSM networks can potentially increase from the current rate of 9.6 kbps up to a theoretical maximum of 171.2 kbps. An increased data rate is by no means the only benefit provided by GPRS. A key advantage is the provision of a permanent virtual connection to the network. This “always on” connection is possible because GPRS uses packet data transfer so that, for example, email can be downloaded in “background mode.” There is no need for the user to re-connect before requesting a service, eliminating connection set-up delays and adding convenience and immediacy to data services access. The “virtual” nature of this connection means that network resources are not consumed during periods when a user is not actually sending or receiving data.

PF B89 telephones have a clam form factor. They are made of a polycarbonate plastic with the display and speaker located in the flip. The bottom part of the clam (front housing) contains the keypad, transceiver printed circuit board (PCB), microphone, flex connection, external accessory connector, smart button, volume buttons, and voice button. The battery and battery door are integrated into a single unit with two types available to provide standard and extended operation. The phone accepts both 3V and 5V mini subscriber identity module (SIM) cards which fit into the SIM holder underneath the bezel on the outside of the flip. The antenna is a fixed stub type antenna. The service indicator (status light) displays flashing green while in-service, flashing amber when roaming, flashing red while out of service, and alternating red / green when ringing.

## Features

PF B89 telephones use advanced, self-contained, sealed, custom integrated circuits to perform the complex functions required for GSM GPRS communication. Aside from the space and weight advantage, microcircuits enhance basic reliability, simplify maintenance, and provide a wide variety of operational functions.

Features available in this family of telephones include:

- Lower voltage technology that provides increased standby and talk times
- Extended GSM (EGSM) channels
- Tri-coder/decoder (CODEC) that allows full rate, half rate, and enhanced full rate modes of transmission
- Supports SMS, concatenated SMS, and cell broadcast messages
- Supports GPRS, circuit switched, and SMS networks
- WAP 1.1 compliant
- 96 x 64 pixel liquid crystal display (LCD) with 3 lines of text, 1 line of icons, and 1 line of prompts
- Display zoom

- Display animation
- VibraCall® vibrating alert
- Voice recorder personal memo feature
- Voice activation for phone book entries and menu shortcuts
- Simplified text entry using iTAP™ predictive text entry
- Supports calling name presentation
- Supports call forwarding for incoming voice, fax, and data calls
- Supports 3V and 5V SIM cards
- SIM Toolkit (STK), Class II
- USB and RS-232 connectivity
- Supports TrueSync® synchronization

### Speaker Dependant Voice Recognition and Voice Note Recording

This feature allows voice tags to be used for voice dialing up to 20 phone numbers in the phone book and for creating up to 5 voice shortcuts for menu items. The phone must be “trained” by the voice tag being read into the phone’s memory twice before it is recognized.

Voice tags can be added to the phone’s memory using the usual name addition methods (i.e., via the phone book menu structure or with the shortcut editor).



*The user cannot place or receive calls while adding voice tags to the phone’s memory.*



*Because the GSM standard does not provide the option to store voice tags onto the SIM card, voice tags are added to the phone’s memory.*

PF B89 telephones also include a voice note recorder that allows up to 2 minutes of personal messages to be recorded. This feature has a complete set of record, playback, and management tools that make it easy to store and maintain a list of personal memos.

### Wireless Access Protocol (WAP) 1.1 Compliancy

In the WAP environment, access to the Internet is initiated in wireless markup language (WML), which is derived from hypertext markup language (HTML). The request is passed to a WAP gateway which retrieves the information from the server in standard HTML (subsequently filtered to WML) or directly in WML if available. The information is then passed to the mobile subscriber via the mobile network.

The PF B89’s microbrowser can be configured for baud, idle timeout, line type, phone number, and connection type.



*Bitmap image data will download as text. If the image is larger than the screen, only part of the image will display.*



*When the user receives a call while in browser mode, the browser will pause and allow the user to resume after completing the call.*

## Simplified Text Entry

There are three different ways to enter text using the phone keypad:

- iTAP™ predictive text entry. Press a key to generate a character and a dynamic dictionary uses this to build and display a set of word or name options. The iTAP™ feature may not be available on the phone in all languages.
- Tap. Press a key to generate a character.
- Numeric. The keypad produces numeric characters only. For some text areas this is the only method available; for example, phone numbers.

## Caller Line Identification

Upon receipt of a call, the calling party's phone number is compared to the phone book. If the number matches a phone book entry, that name will be displayed. If there is no phone book entry, the incoming phone number will be displayed. In the event that no caller identification information is available, the Incoming Call message is displayed.



*User must subscribe to a caller line identification service through their service provider.*

## Call Forwarding

Call forwarding is a network feature that diverts incoming calls to another phone number if the user or phone is unavailable, or the user does not wish to receive calls. This option can be used to:

- Divert all incoming voice calls unconditionally
- Divert incoming voice calls whenever the phone is unavailable, busy, not reachable, or not answered
- Divert incoming fax calls
- Divert incoming data calls
- Allow all calls through to the phone.

Detailed operating instructions for these and the other PF B89 features can be found in the appropriate PF B89 telephone user's guide listed in the "Related Publications" section toward the end of this manual.

# General Operation

## Controls, Indicators, and Input / Output (I/O) Connections

The PF B89 telephone's controls are located on the sides of the device and on the keypad. Indicators, in the form of icons, are displayed on the LCD (see Figure 3). Service status is indicated by a tri-color light emitting diode (LED) located on top of the phone. Additionally, I/O connectors consisting of a headset jack and an accessory port are located on the top and bottom of the phone, respectively. See Figure 1.

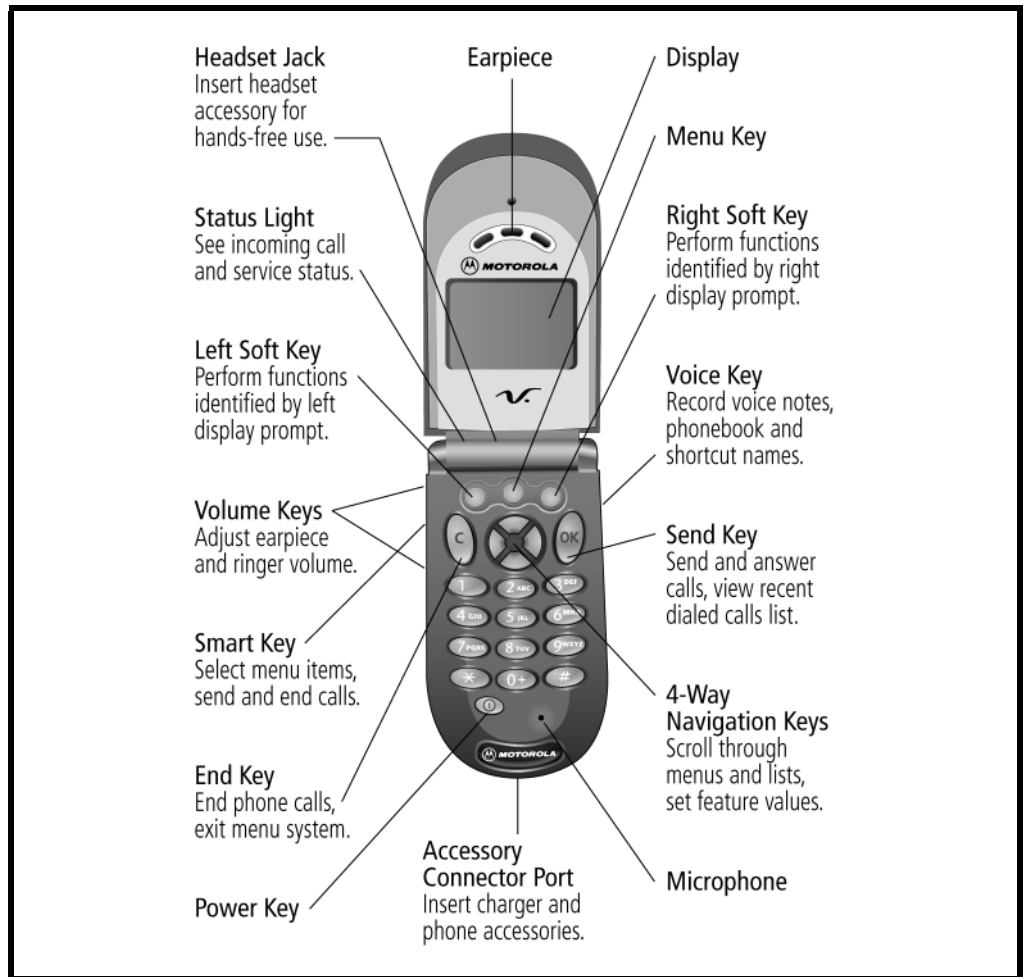

010417o

Figure 1. PF B89 Telephone Controls, indicators, and I/O

## Menu Navigation

PF B89 telephones are equipped with a new user-friendly interface that employs soft keys and a 4-way navigation key to access phone functions and features. See Figure 2.

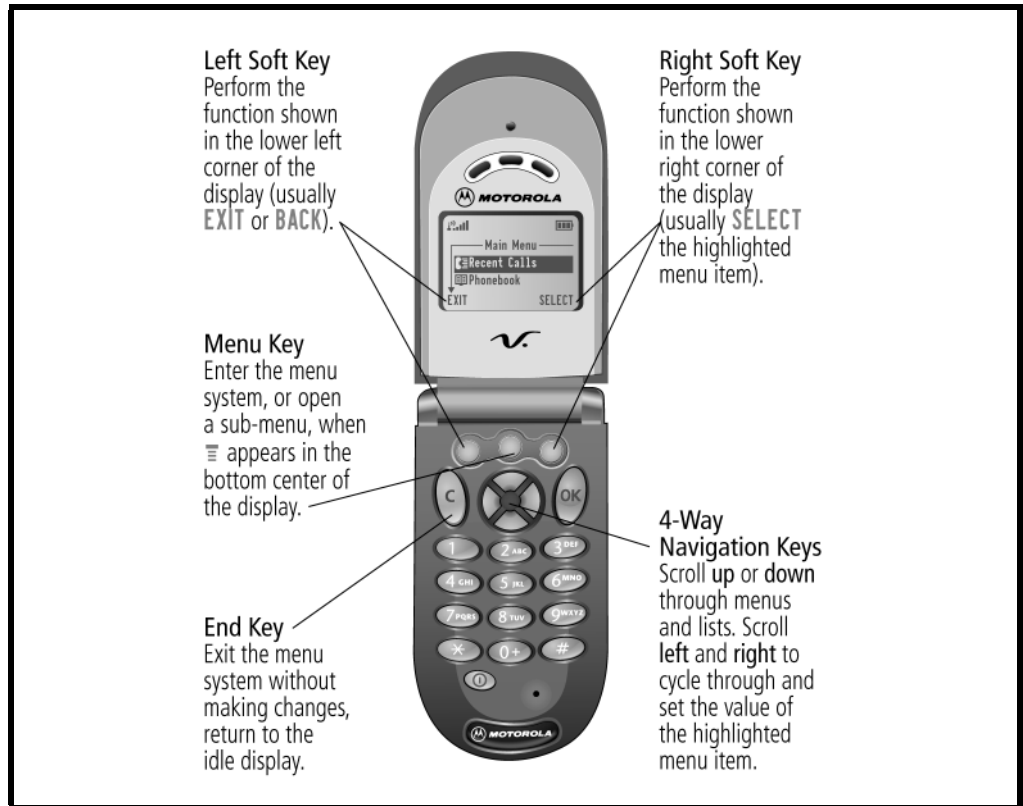

010418o

**Figure 2. PF B89 Menu Navigation**

“Soft keys” refer to non-labeled keys that correspond to text options displayed on the screen. The left and right soft keys perform the function shown in the corners of the display. The left key will usually select an option whereas the right key will usually exit a function or return to a previous screen.

The menu key opens the initial menu structure, or allows access to a submenu whenever  appears on the screen. See Figure 4 for details of the PF B89 menu structure.

## Liquid Crystal Display (LCD)

The LCD provides a high contrast backlit display for easy readability in all light conditions. The large bit-mapped 96 x 64 display includes 3 lines of text, 1 line of icons, and 1 line of prompts.

Display zoom allows setting the phone’s display to show either three lines or two lines of text plus soft key labels. Three lines of text display more information, while two lines increase text size for improved visibility.

Display animation makes the phone's menus move smoothly as the user scrolls up and down. Turn animation off to conserve the battery.

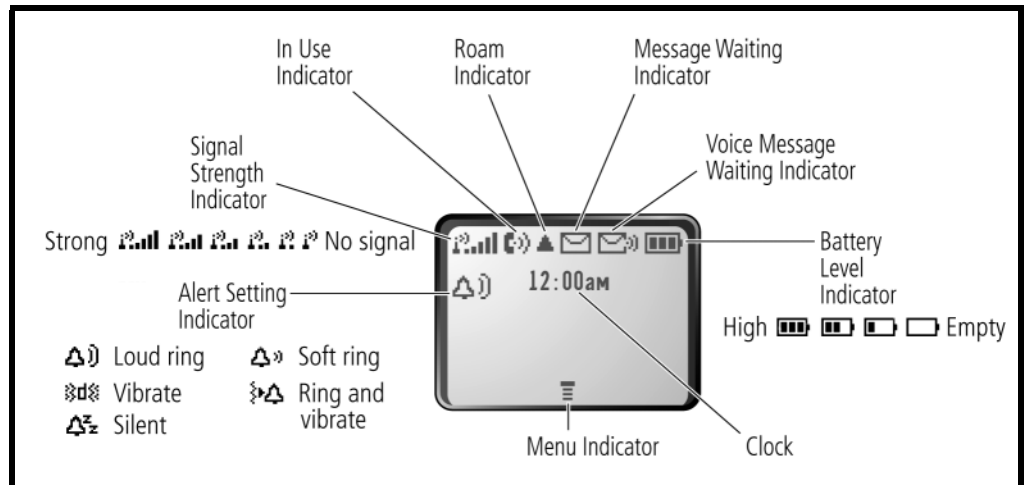

010419o

**Figure 3. PF B89 Icon Indicators**



*Whether a phone displays all indicators depends on the programming and services to which the user subscribes.*

Figure 3 shows some common icons displayed on the LCD.

- **Signal Strength Indicator.** Shows the strength of the phone's connection with the network. Calls cannot be sent or receive when the "no signal" indicator is displayed.
- **In Use Indicator.** Appears when a call is in progress.
- **Roam Indicator.** Appears when the phone uses another network system outside the user's home network. When leaving the home network area, the phone roams, or seeks, another network.
- **Message Waiting Indicator.** Appears when the phone receives a text message. This is a network-dependent feature.
- **Voice Message Waiting Indicator.** Appears when a voicemail message is received. This is a network-dependent feature.
- **Battery Level Indicator.** Shows the amount of charge left in the battery. The more segments visible, the greater the charge. Recharge the battery as soon as possible when the Low Battery warning message appears.
- **Clock.** Shows the current time. This is a network-dependent feature.
- **Menu Indicator.** Indicates the user can press the menu soft key to open a menu.
- **Alert Setting Indicator.** Shows the current selected alert. The default alert setting is a ringer.

## User Interface Menu Structure

Figure 4 shows the PF B89 telephone menu structure.

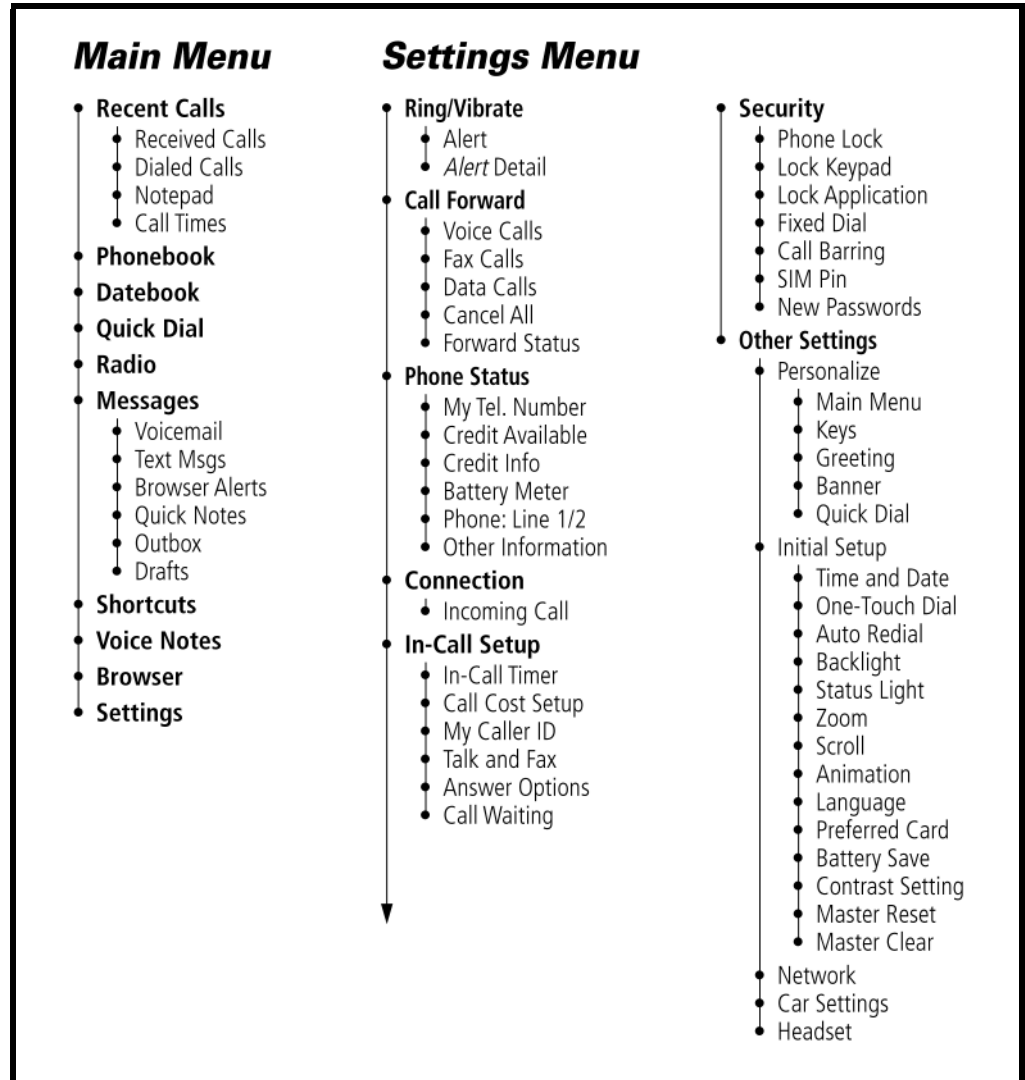

Figure 4. PF B89 Menu Structure

0104200

## Alert Settings

PF B89 telephones include up to 32 preset alert tones and vibrations that can be applied to all alert events at the same time.



*Pressing either volume key will mute the alert.*



---

## Battery Function

### Battery Gauge

The telephone displays a battery level indicator icon in the idle screen to indicate the battery charge level. The gauge shows four levels: 100%, 66%, 33%, and Low Battery.

### Battery Removal

Removing the battery causes the device to immediately shut down and any pending work (for example, partially entered phone book entries or outgoing messages) is lost.



*To ensure proper memory retention, turn OFF the phone before removing the battery. Immediately replace the old battery with a fresh battery.*



*If the battery is removed while receiving a message, the message will be lost.*

## Operation

For detailed operating instructions, refer to the appropriate User's Guide listed in the Related Publications section toward the end of this manual.



## Tools and Test Equipment

The following table lists tools and test equipment recommended for disassembly and reassembly of PF B89 telephones. Use either the listed items or equivalents.

**Table 1. General Test Equipment and Tools**

Motorola Part Number <sup>1</sup>	Description	Application
RSX4043-A	Torque Driver	Used to remove and replace screws
—	Torque Driver Bit T-6 Plus, Apex 440-6IP Torx Plus or equivalent	Used with torque driver
—	Torque Driver Bit T-4 Plus, Apex 440-6IP Torx Plus or equivalent	Used with torque driver
SPN4716A	Rapid Charger	Used to charge battery and to power device
0180386A82	Antistatic Mat Kit (includes 66-80387A95 antistatic mat, 66-80334B36 ground cord, and 42-80385A59 wrist band)	Provides protection from damage to device caused by electrostatic discharge (ESD)
6680388B67	Disassembly tool, plastic with flat and pointed ends (manual opening tool)	Used during assembly/disassembly of device
6680388B01	Tweezers, plastic	Used during assembly/disassembly
—	Tweezers, stainless steel, Type 2 pointed blade, Plato part number TZF-401-2 or equivalent <sup>2</sup>	Used for flip removal.
—	Wire cutters, diagonal (side cutters)	Used to remove light guide
—	Digital Multimeter, HP34401A <sup>3</sup>	Used to measure battery voltage
8102430Z04	GSM / DCS Test SIM Card	Used to enable manual test mode

1. To order in North America, contact Motorola Aftermarket and Accessories Division (AAD) at (847) 538-8000; Internationally, AAD can be reached by calling (847) 538-8023 or faxing (847) 576-3023.

2. Not available from Motorola. To order, contact Plato Products, Inc. at (626) 965-8044.

3. Not available from Motorola. To order, contact Hewlett Packard at (800) 452-4844.

## Disassembly

The procedures in this section provide instructions for the disassembly of a PF B89 telephone. Tools and equipment used for the phone are listed in Table 1, preceding.



*Many of the integrated devices used in this equipment are vulnerable to damage from electrostatic discharge (ESD). Ensure adequate static protection is in place when handling, shipping, and servicing the internal components of this equipment.*



*Avoid stressing the plastic in any way to avoid damage to either the plastic or internal components.*

## Removing and Replacing the Battery



*All batteries can cause property damage and/or bodily injury such as burns if a conductive material such as jewelry, keys, or beaded chains touch exposed terminals. The conductive material may complete an electrical circuit (short circuit) and become quite hot. Exercise care in handling any charged battery, particularly when placing it inside a pocket, purse, or other container with metal objects.*

1. Ensure the phone is turned off.
2. Slide the battery release latch in the direction of the arrow (see Figure 5).
3. Lift the end of the battery and remove it completely.

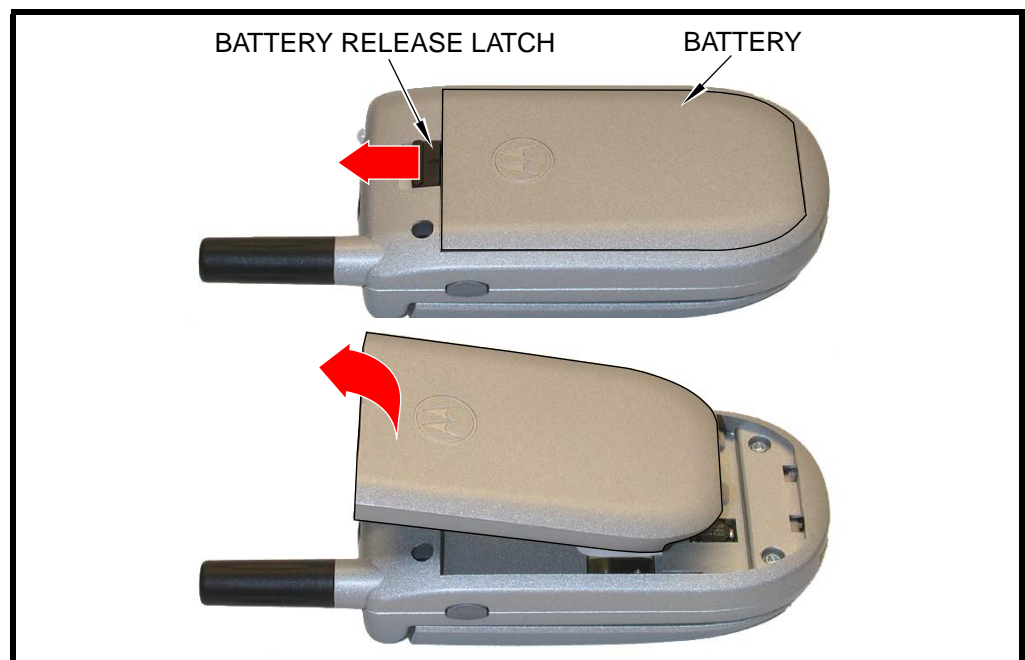

010421o

Figure 5. Removing the battery



*There is a danger of explosion if the Lithium Ion battery is replaced incorrectly. Replace only with the same type of battery or equivalent as recommended by the battery manufacturer. Dispose of used batteries according to the manufacturer's instructions.*

4. To replace, Align the battery with the battery compartment so the contacts on the battery match the battery contacts in the phone.
5. Insert the tabs at the base of the battery into the slots at the bottom of the battery compartment.
6. Push the top of the battery down until it snaps into place.

## Removing and Replacing the Subscriber Identity Module (SIM)

1. Remove the battery as described in the procedures.
2. Pull up at the base of the bezel insert on the outside of the flip assembly and lift the bezel completely off the phone. See Figure 6.

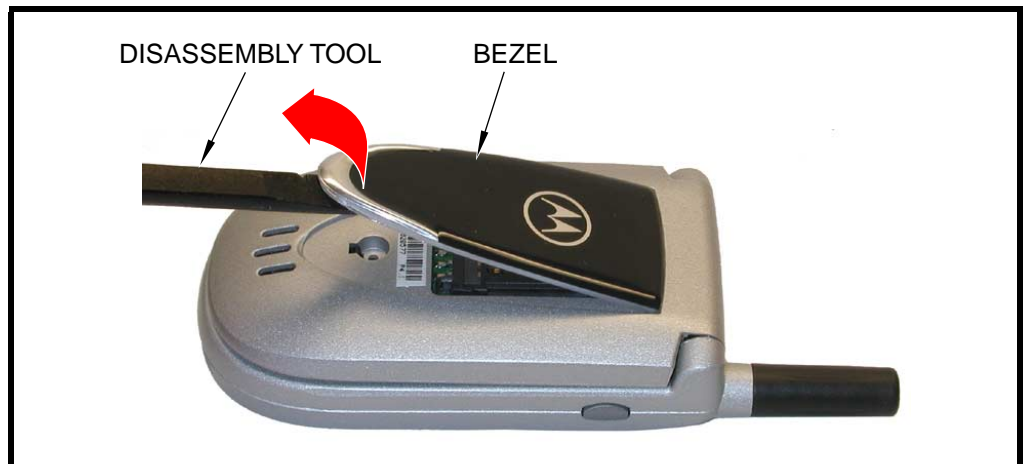

010422o

**Figure 6. Removing the bezel**

3. Slide the SIM holder down (away from the antenna) to unlock (Figure 7A) and rotate to open as shown in Figure 7B.
4. Carefully slide the SIM from its holder.

- To replace, insert the SIM into the holder, ensuring the keyed corner of the SIM aligns with the notch molded into the holder.

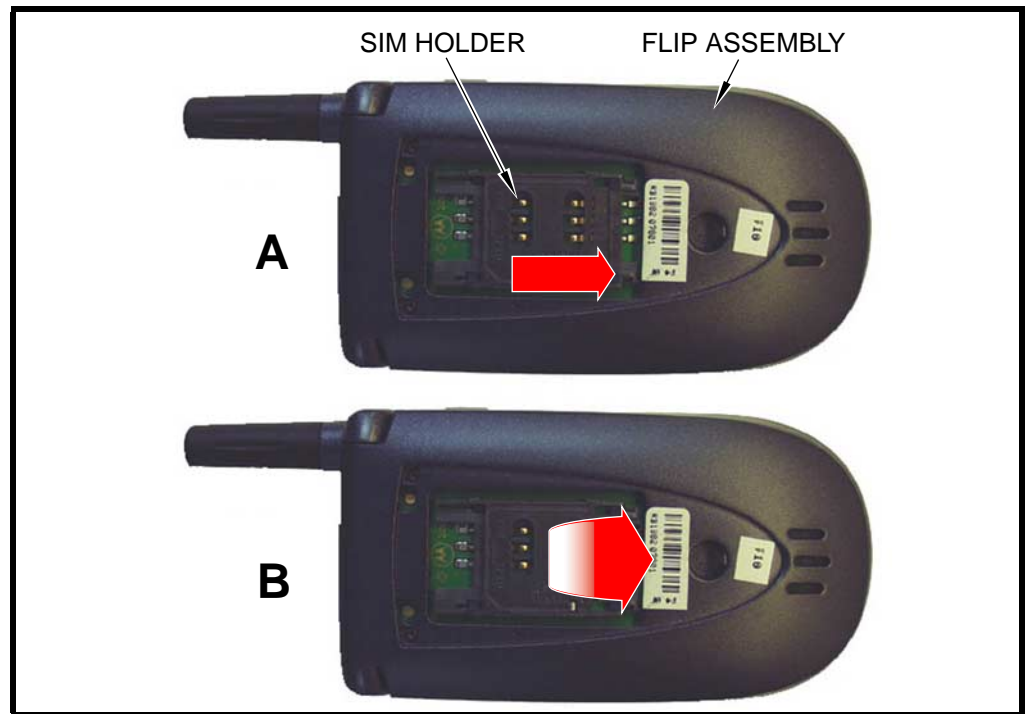

010423o

**Figure 7. Removing the SIM card**

- Close the SIM holder and slide it up (toward the antenna) to lock.
- Replace the bezel, making sure it snaps firmly in place.
- Replace the battery as described in the procedures.

## Removing and Replacing the Antenna

1. Remove the battery as described in the procedures.
2. By hand, rotate the antenna counterclockwise until loose. See Figure 8.

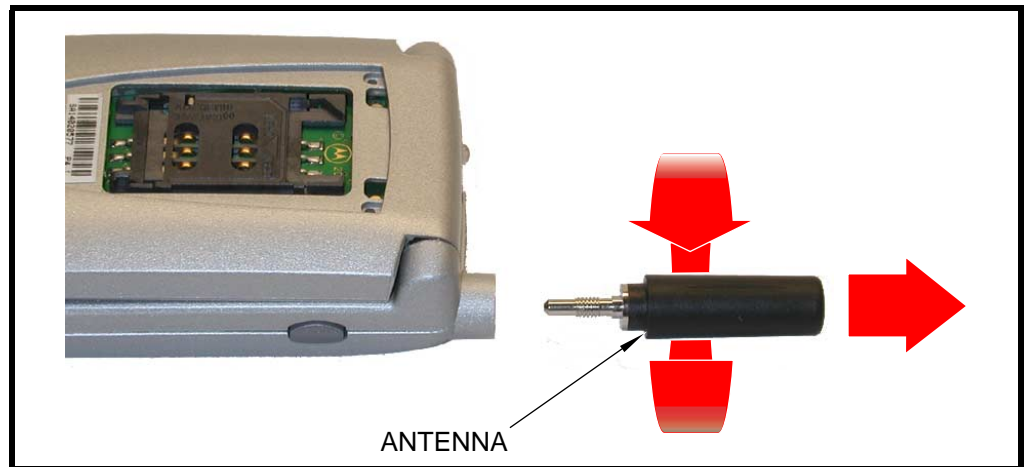

010424o

**Figure 8. Removing the antenna**

3. When the antenna threads are completely disengaged, pull the antenna straight out of the phone housing to remove.



*Ensure antenna threads are properly engaged before tightening to prevent damage to the antenna or housing.*

4. To replace, insert the threaded end of the antenna carefully into the housing and, after ensuring the threads are properly engaged, rotate clockwise. Tighten firmly by hand.
5. Replace the battery as described in the procedures.

## Removing and Replacing the Light Guide

1. Remove the battery as described in the procedures.



*Be careful not to mar the surface of the phone housing or the light guide when using diagonal cutters in the following step.*

2. Using the diagonal cutters, gently grasp the exposed portion of the light guide and pull straight out of the housing. See Figure 9.

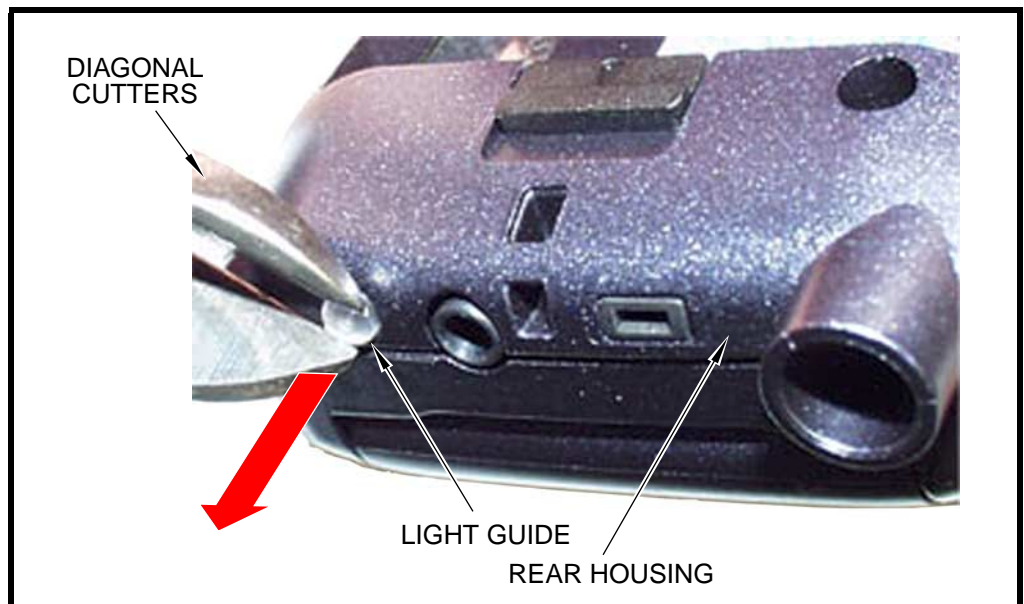

**Figure 9. Removing and the light guide**

3. To replace, insert the light guide straight into the opening in the top of the rear housing and push until fully seated.
4. Replace the battery as described in the procedures.

## Removing and Replacing the Rear Housing



*This product contains static-sensitive devices. Use anti-static handling procedures to prevent electrostatic discharge (ESD) and component damage.*

1. Remove the battery, antenna, and light guide as described in the procedures.



*In addition to 2 screws, the rear housing is fastened with plastic catches. These are fragile and should be released with care.*



2. Using a Torx driver with a T-6 bit, remove the 2 screws from the bottom of the rear housing. See Figure 10.
3. With the flat end of the disassembly tool, carefully pry the 2 housing catches inward to release the rear housing.

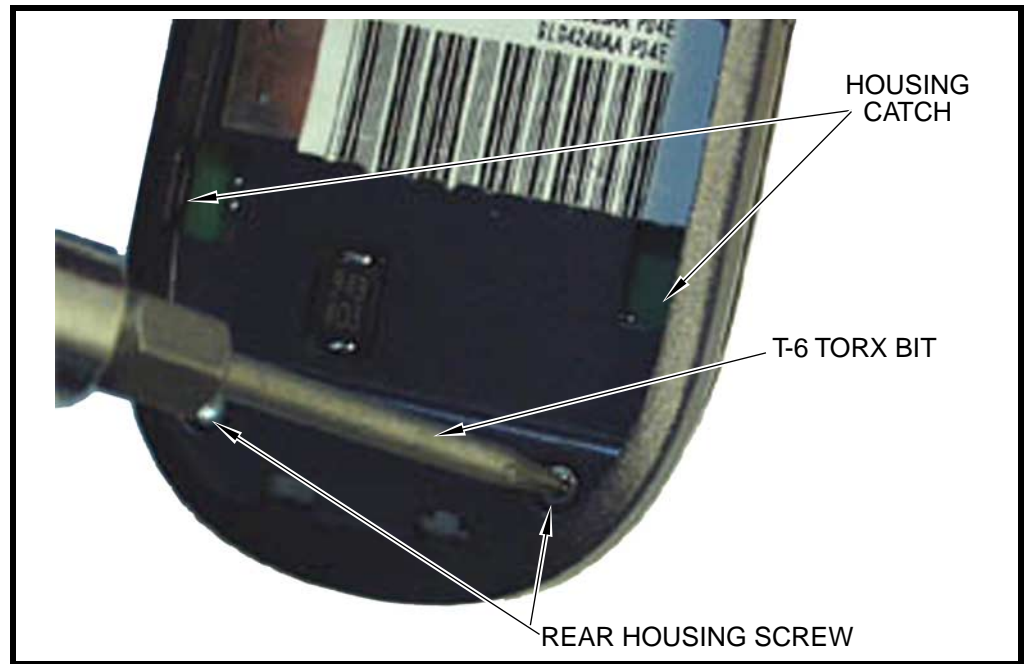

0104260

Figure 10. Removing the rear housing screws and catches

4. Lift the rear housing away from the front housing to remove as shown in Figure 11.

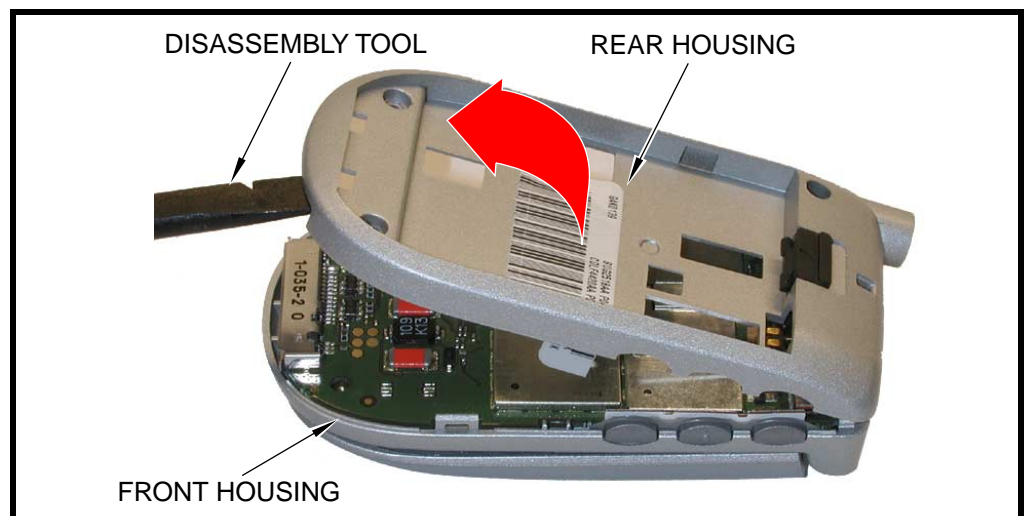

0104270

Figure 11. Removing the rear housing

5. To replace, align the opening in the top of the rear housing with the alert transducer on the transceiver board, then rotate the rear housing down until the 2 housing catches engage with the corresponding openings on the rear housing. Press the housings together until the catches snap into place.
6. Replace the 2 screws and tighten securely. Do not over tighten.
7. Replace the light guide, antenna, and battery as described in the procedures.

## Removing and Replacing the Transceiver Board Assembly



*This product contains static-sensitive devices. Use anti-static handling procedures to prevent electrostatic discharge (ESD) and component damage.*

1. Remove the battery, antenna, light guide, and rear housing as described in the procedures.



*The flexible printed cable (FPC) (flex) is easily damaged. Exercise extreme care when handling.*

2. Carefully work the flat end of the disassembly tool under the flex connector and remove the connector from the transceiver board. See Figure 12.

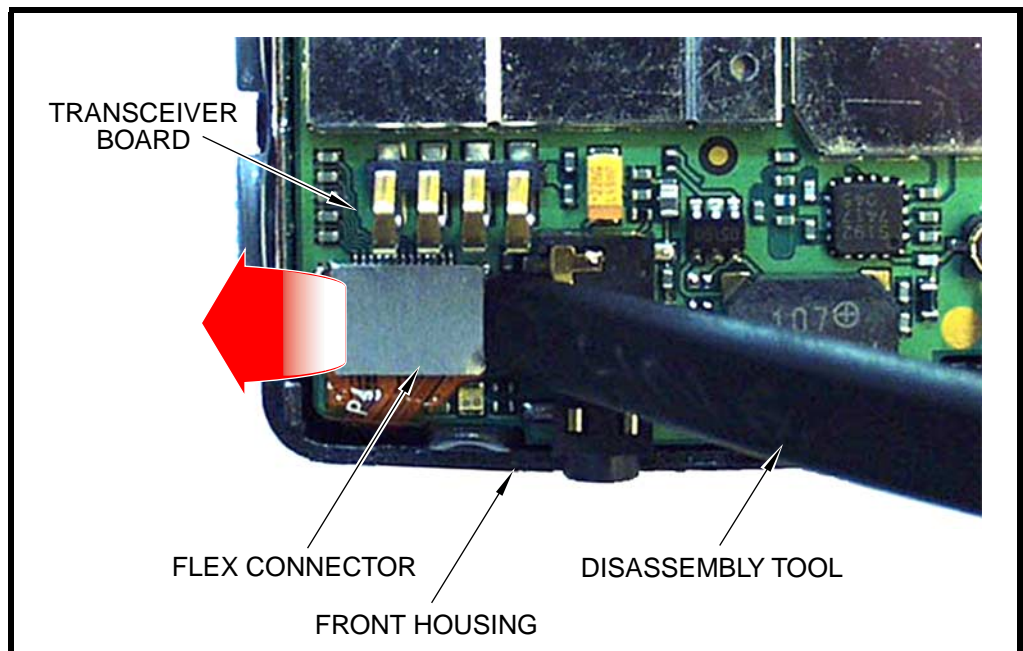

**Figure 12. Disconnecting the flex from the transceiver board**

3. Lift the transceiver board assembly from the front housing. See Figure 13.

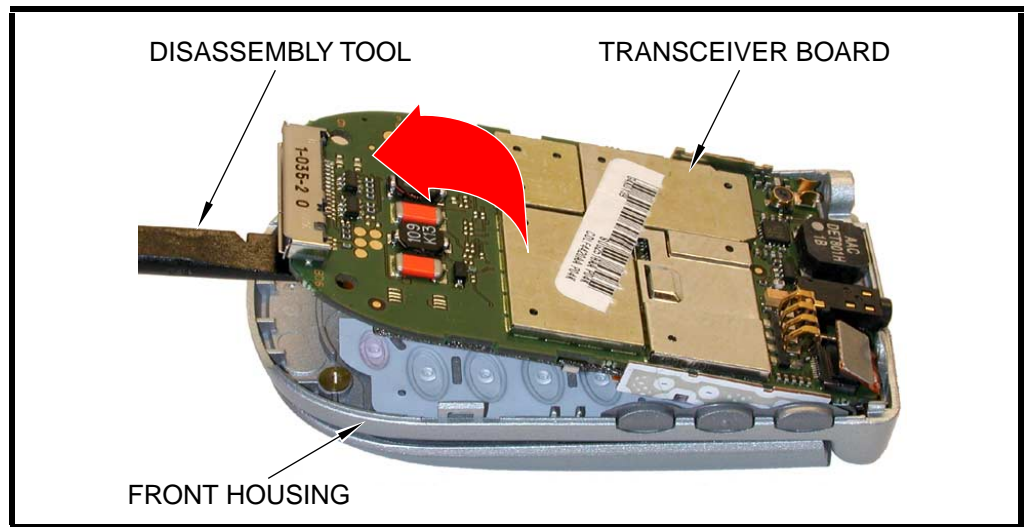

**Figure 13. Removing the transceiver board assembly**

4. To replace, insert the transceiver board assembly into the front housing with the flex connector on top. Ensure the keypad PCB is properly aligned with the keypad.



*Be sure the volume/smart buttons and voice button are correctly positioned in relation to the corresponding switch contacts on the keypad PCB. Verify operation of the buttons after replacing the transceiver board and rear housing.*

5. Insert the flex connector squarely into its mating connector on the transceiver board and press firmly until it snaps into place.
6. Replace the rear housing, light guide, antenna, and battery as described in the procedures.

## Removing and Replacing the Keypad PCB

1. Remove battery, antenna, light guide, rear housing, and transceiver board assembly as described in the procedures.
2. While holding the transceiver board assembly stationary with the keypad PCB facing you, carefully work the flat end of the disassembly tool under the keypad PCB connector to disconnect it from the transceiver board, then lift the keypad PCB away. See Figure 14.

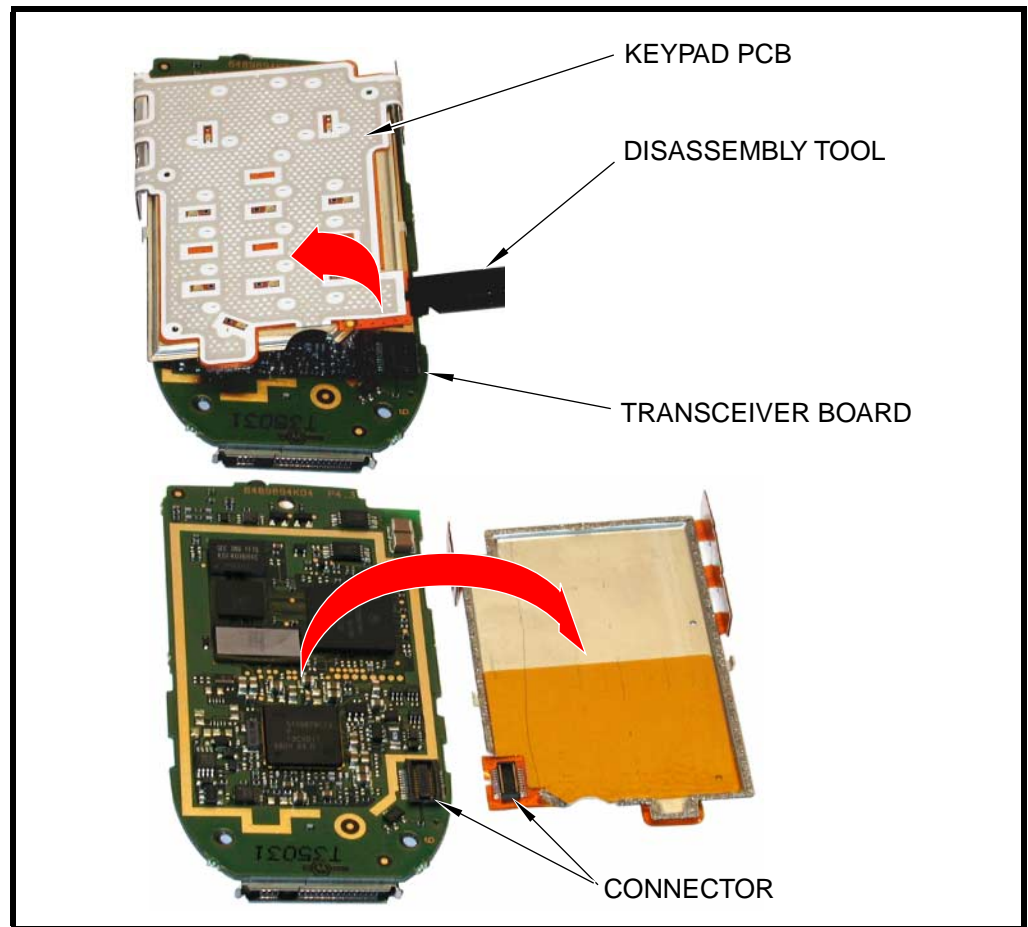

010430o

**Figure 14. Removing the keypad PCB**

3. To replace, align the keypad PCB with the transceiver board so the mating connectors are aligned. Firmly press the keypad PCB connector into the transceiver board connector until it snaps into place.
4. Replace the transceiver board assembly, rear housing, light guide, antenna, and battery as described in the procedures.

## Removing and Replacing the Microphone Assembly

1. Remove the battery, antenna, light guide, rear housing, and transceiver board assembly as described in the procedures.

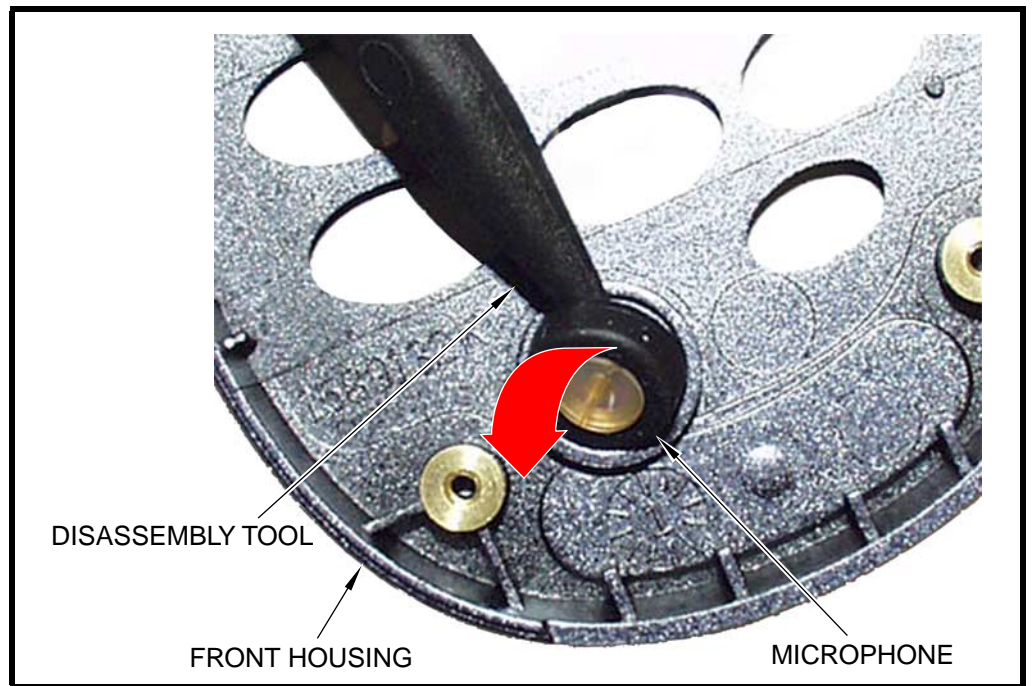

**Figure 15. Removing the microphone assembly**

2. Using the flat end of the disassembly tool, carefully lift the microphone assembly from its front housing cavity. See Figure 15.



*When replacing, ensure the conductive elastomer connector on the microphone grommet is correctly positioned to contact the transceiver board.*

3. To replace, position the microphone assembly in its front housing cavity so the conductive elastomer connector is facing up.
4. Press the microphone assembly gently into place, ensuring it is fully seated in the cavity.
5. Replace the transceiver board assembly, rear housing, light guide, antenna, and battery as described in the procedures.

## Removing and Replacing the Keypad

1. Remove the battery, antenna, light guide, rear housing, and transceiver board assembly as described in the procedures.
2. Lift the keypad from the front housing as shown in Figure 16.

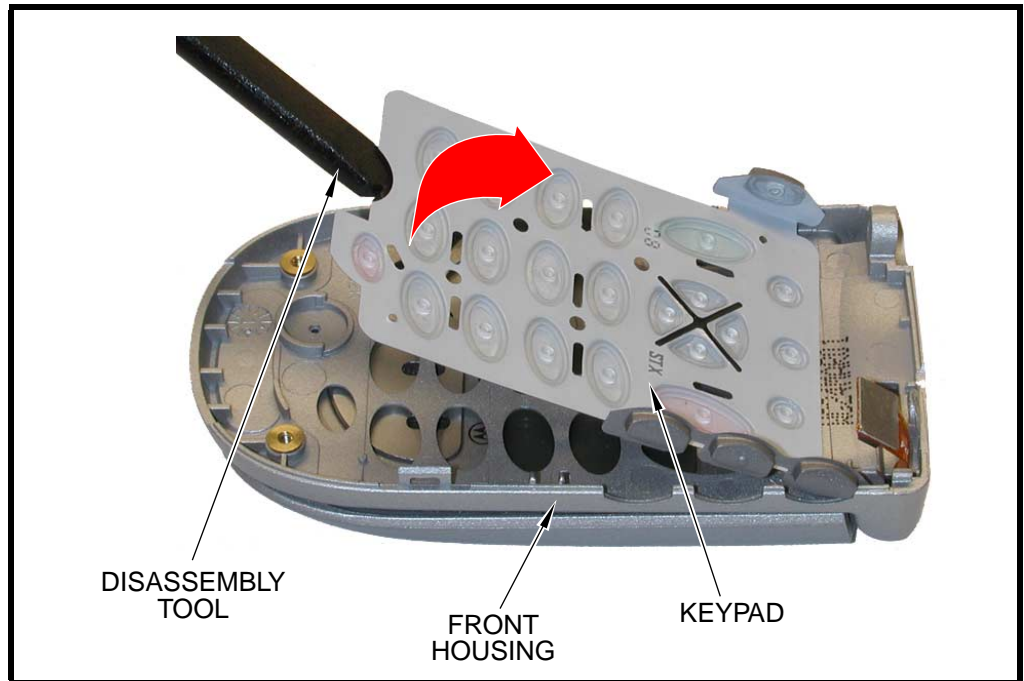

**Figure 16. Removing the keypad**

3. To replace, insert the keypad into the front housing, ensuring the keys align properly with the openings in the front housing.
4. Replace the transceiver board assembly, rear housing, light guide, antenna, and battery as described in the procedures.

## Removing and Replacing the Lens Assembly

1. Remove the battery, SIM, and antenna as described in the procedures.
2. Using a Torx driver with a T-4 bit, remove the 3 screws holding the lens assembly to the flip. See Figure 17A.
3. Carefully work the flat end of the disassembly tool under the sides of the lens assembly at the locations shown by the arrows in Figure 17B.

4. Gently depress the 2 lens assembly catches to release the flip housing. See Figure 18A.

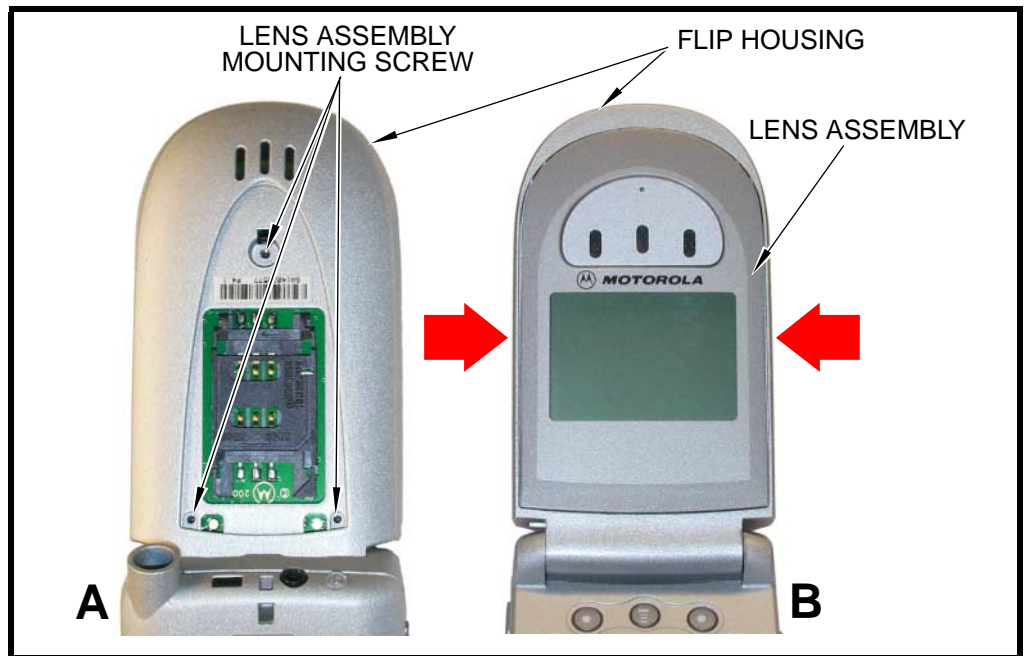

Figure 17. Removing the lens assembly

0104330

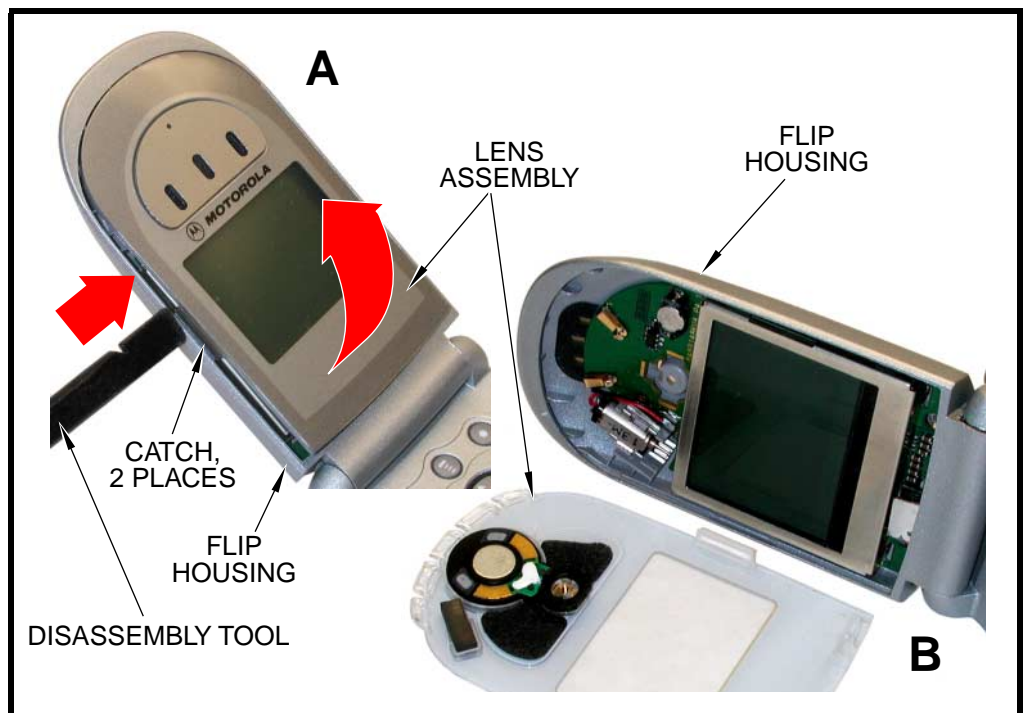

Figure 18. Removing the lens assembly

0104340

5. Lift the lens completely away from the flip as shown in Figure 18B.



*Do not remove the transparent protective film from the front of the new lens. This film prevents damage to the lens during service and handling. It is to be removed only by the end user.*

6. To replace, insert the fingers at the top of the lens into the corresponding recess on the flip housing and rotate the lens down until the 2 catches snap into place.
7. Replace the 3 T-4 screws and tighten securely. Do not overtighten.
8. Replace the antenna, SIM and battery as described in the procedures.

## Removing and Replacing the Real Time Clock (RTC) Battery

1. Remove the battery, SIM, antenna, and lens assembly as described in the procedures.

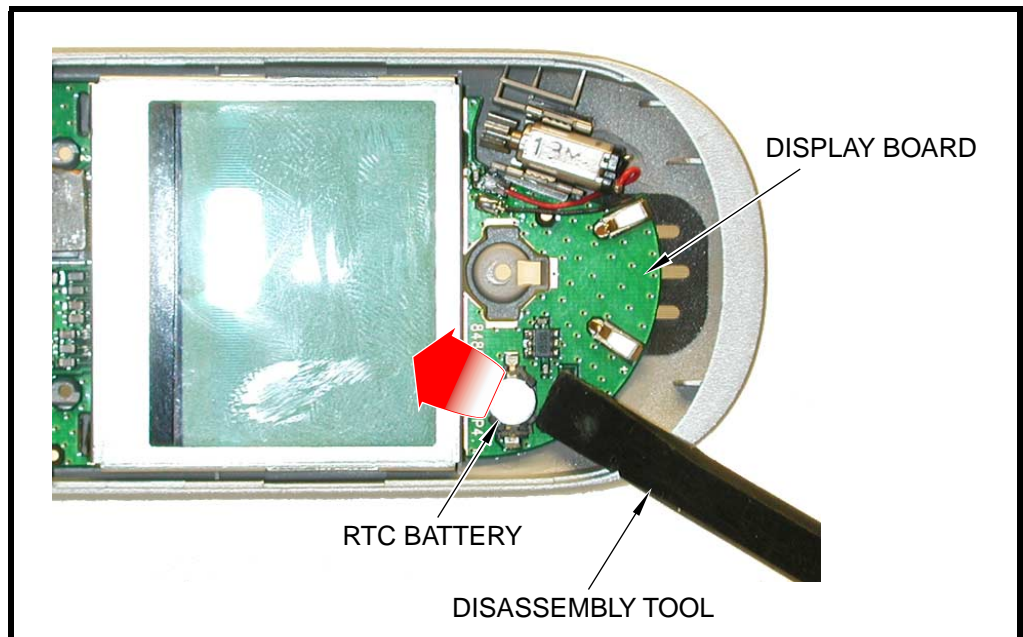

**Figure 19. Removing the RTC battery**

2. Using the flat end of the disassembly tool, gently pry the RTC battery from its socket on the display board. See Figure 19.



*Use only non-conductive tools, such as the plastic disassembly tool and the plastic tweezers, when removing and replacing the RTC battery.*

3. To replace, insert the new RTC battery into its socket on the display board. The plastic tweezers may be used to replace the RTC battery. Be sure the



positive battery terminal is up (facing away from the display board) and the battery is completely seated in its socket.

4. Replace the lens assembly, antenna, SIM, and battery as described in the procedures.

## Removing and Replacing the Display Board Assembly



*This product contains static-sensitive devices. Use anti-static handling procedures to prevent electrostatic discharge (ESD) and component damage.*

1. Remove the battery, SIM, antenna, and lens assembly as described in the procedures.



*In some models, the flex connector may be padded with foam rubber.*

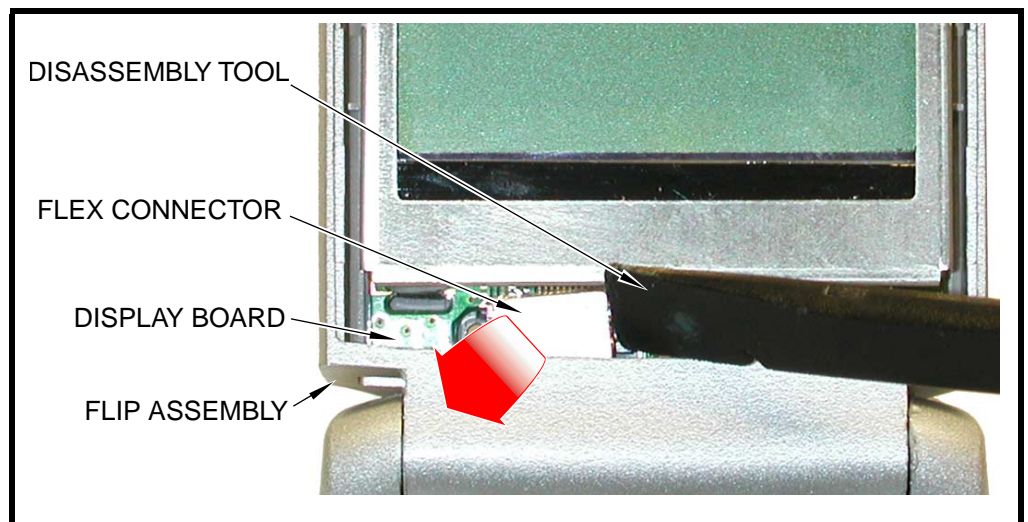

0104360

**Figure 20. Disconnecting the flex from the display board assembly**

2. Carefully work the flat end of the disassembly tool under the flex connector and remove the connector from the display board as shown in Figure 20.



*The vibrator is connected to the display board with wire leads. Exercise care to not damage the wires when removing and replacing the display board and vibrator.*

- Using the flat end of the disassembly tool, gently pry the vibrator from the flip housing. See Figure 21.

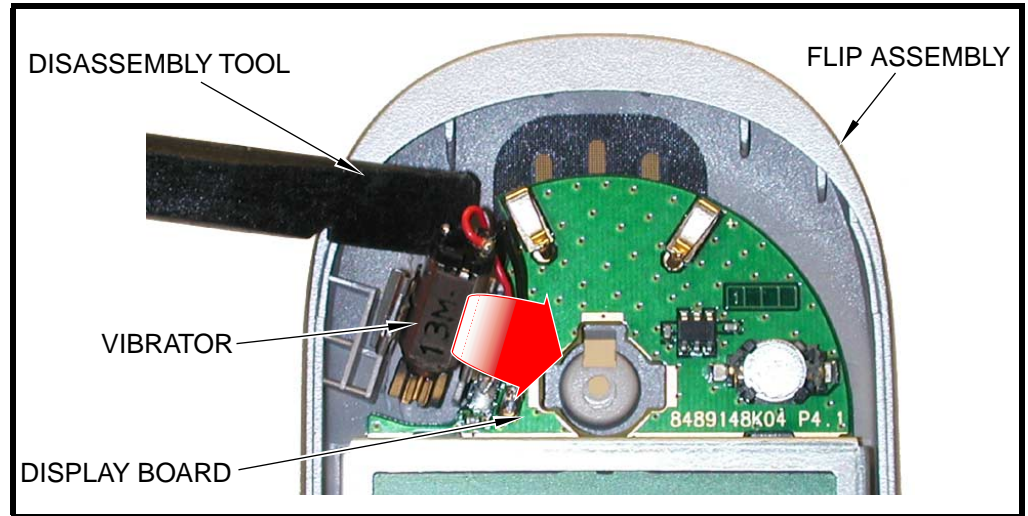

010437o

Figure 21. Removing the vibrator from the flip housing

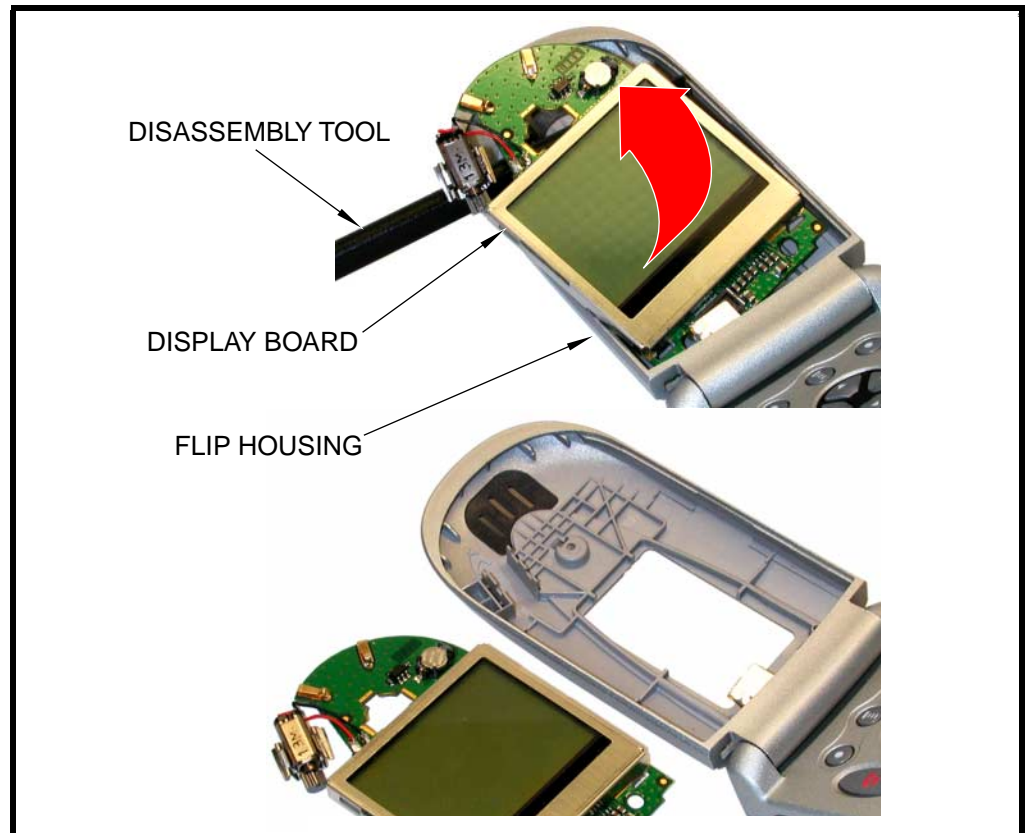

010438o

Figure 22. Removing the display board assembly

4. Lift the display board assembly from the flip housing as shown in Figure 22.
5. To replace, insert the display board into the flip housing, ensuring the display board is properly seated.
6. Using the disassembly tool, align and connect the flex to the display board. Apply slight pressure to the flex connector until it snaps into place.
7. Align the vibrator and vibrator bracket with the mounting tabs molded into the flip housing. Press firmly in place, making sure the bracket is properly seated and the vibrator's shaft clears the display board and can rotate without binding.
8. Replace the lens assembly, antenna, SIM, and battery as described in the procedures.

## Removing and Replacing the LCD Module

1. Remove the battery, SIM, antenna, lens assembly, and display board assembly as described in the procedures.

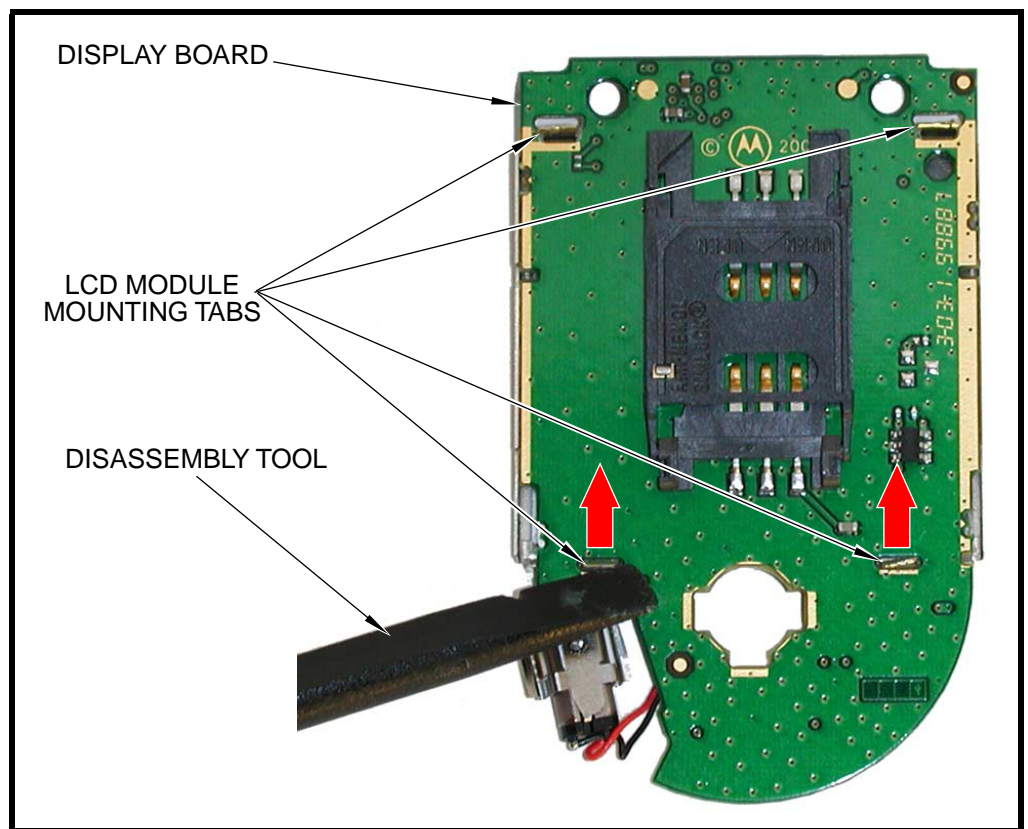

0104390

**Figure 23. Releasing the LCD module mounting tabs**



*Exercise extreme care when bending the LCD module mounting tabs as described in this procedure. They are fragile and easily broken.*

2. Locate the 4 LCD module mounting tabs shown in Figure 23.
3. Using the flat end of the disassembly tool, straighten the 2 LCD module tabs shown in the figure.

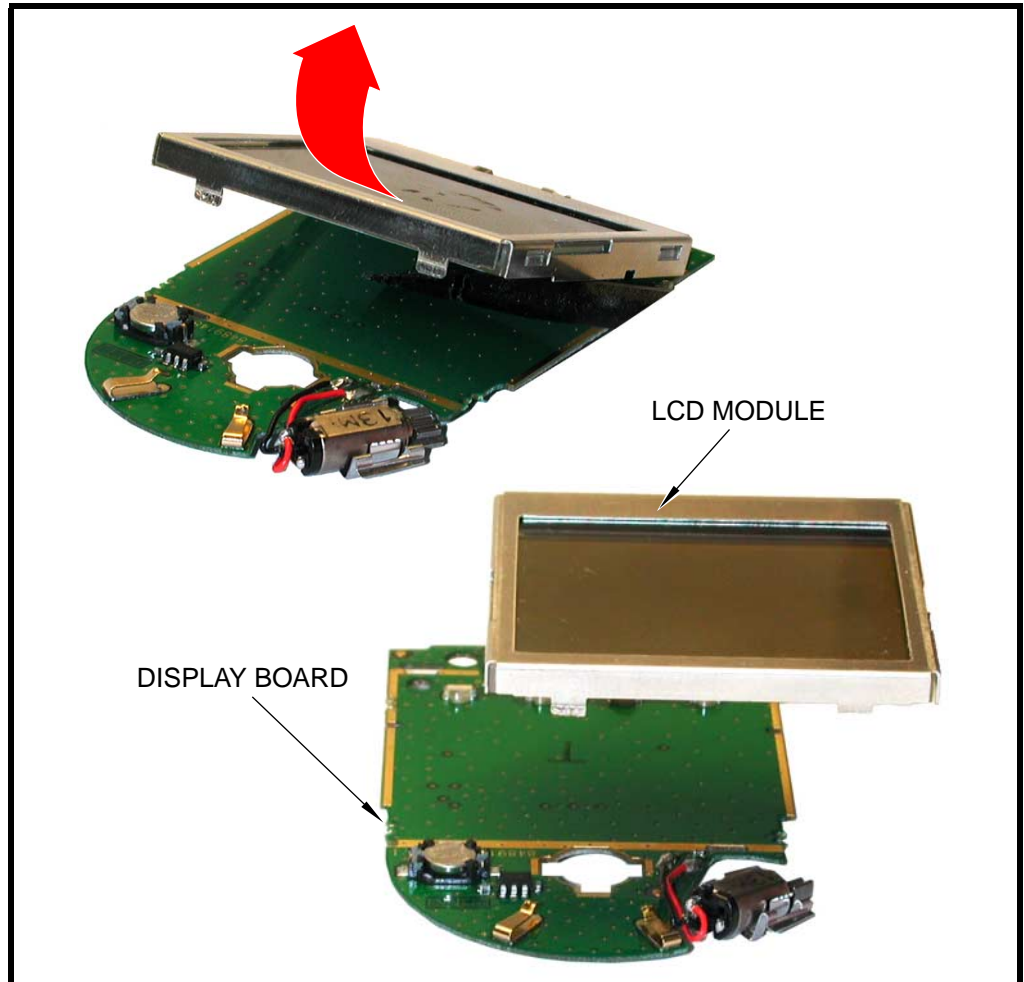

Figure 24. Removing the LCD module

010440o

4. Tilt up and remove the LCD module from the display board assembly as shown in Figure 24.



*When replacing the LCD module, be sure the LCD module is mounted flat against the transceiver board. Any gap between the LCD module and the transceiver board can result in poor contact and display failure.*

5. To replace, insert the LCD module mounting tabs into the corresponding display board slots.
6. Hold the LCD module tight against the display board and slightly bend the tabs shown in Figure 23 to fasten the module in place.

7. Replace the display board assembly, lens assembly, antenna, SIM, and battery as described in the procedures.

## Removing and Replacing the Flip Housing



*The printed flexible cable (flex) is very fragile. Use extreme care when removing and replacing the flip assembly.*

1. Remove the battery, SIM, antenna, light guide, rear housing, transceiver board assembly, microphone assembly, keypad, lens assembly, and display board assembly as described in the procedures.



*After releasing the hinge mechanism in the following step, DO NOT attempt to completely separate the flip housing from the front housing until you have safely routed the flex through the slot in the front housing.*

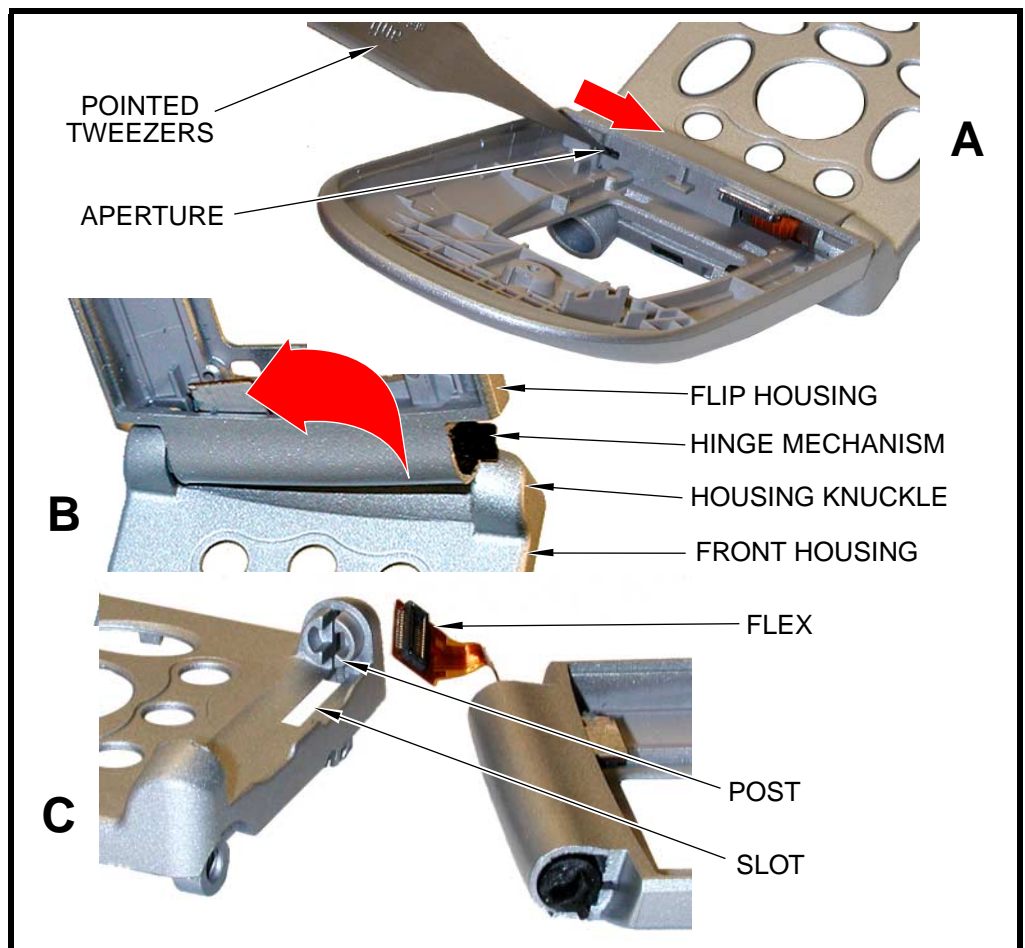

Figure 25. Removing the flip housing

0104410

2. Using the pointed tweezer through the flip housing aperture, depress the hinge mechanism to release the flip housing from the front housing knuckle. See Figure 25A.
3. Carefully tilt and slightly separate the flip housing (Figure 25B), flex still attached, from the front housing. Pull the flex through the front housing slot then completely separate the housings as shown in Figure 25C.
4. To replace, insert the front housing hinge post into the flip housing while carefully routing the flex through the slot in the front housing.
5. Using the disassembly tool, depress the hinge mechanism and slide the end of the hinge into the corresponding slots molded into the front housing. The hinge will snap into place when it is properly aligned with the front housing.
6. Replace the display board assembly, lens assembly, keypad, microphone assembly, transceiver board assembly, rear housing, light guide, antenna, SIM, and battery as described in the procedures.

## Removing and Replacing the Flex Assembly

1. Remove the battery, SIM, antenna, light guide, rear housing, transceiver board assembly, microphone assembly, keypad, lens assembly, display board assembly, and flip housing as described in the procedures.

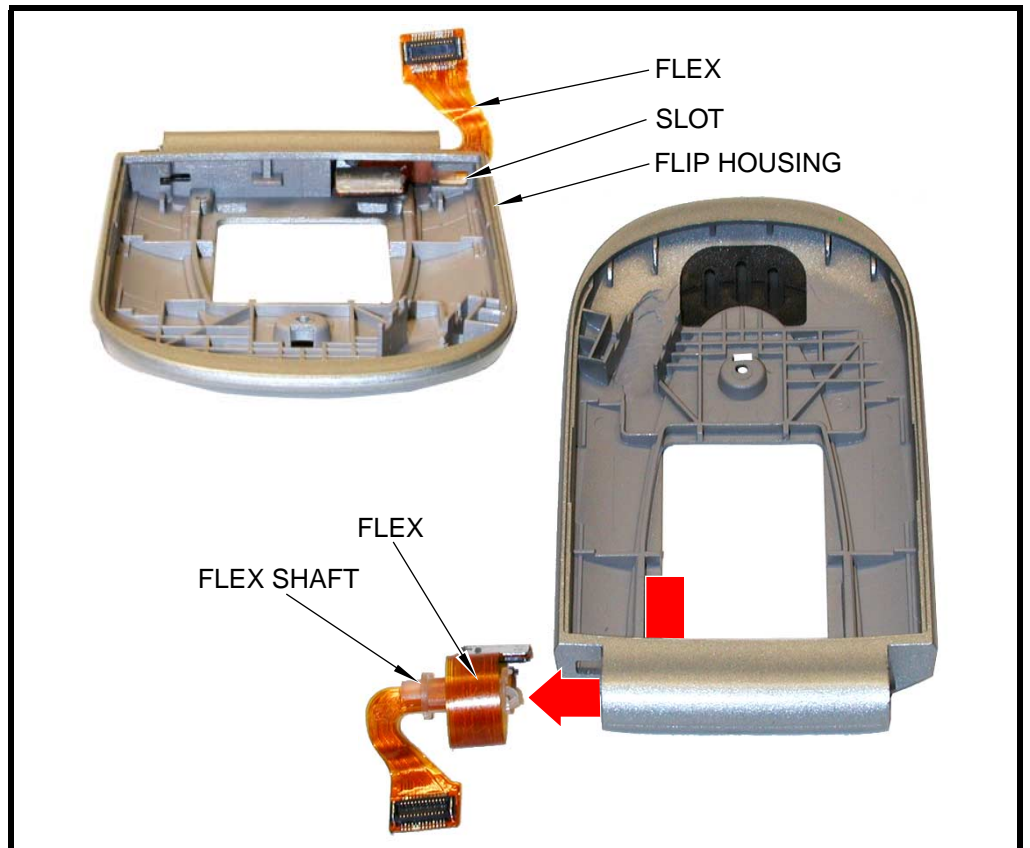

010442o

**Figure 26. Removing the flex assembly**

2. Carefully route the flex through the slot in the flip housing and remove completely as shown in Figure 26.
3. To replace, while holding the flex tightly wound around the flex shaft, insert the flex and flex shaft into the flip housing. Be sure the flex is not pinched or crimped within the housing.
4. Replace the flip assembly, lens assembly, keypad, microphone assembly, transceiver board assembly, rear housing, light guide, antenna, SIM, and battery as described in the procedures.





## SIM Cards and Identification

### SIM Card

A SIM card is required to access the existing local GSM network, or remote networks when traveling (if a roaming agreement has been made with the provider).

The SIM card contains:

- All the data necessary to access GSM services.
- The ability to store user information such as phone numbers.
- All information required by the network provider to provide access to the network.

### Personality Transfer

A personality transfer is required when a phone is Express Exchanged or when the main board is replaced. Personality transfers reproduce the customer's original personalized details such as menu and stored memory such as phone books, or even just program a unit with basic user information such as language selection. PF B89 telephones use TrueSync® synchronization software to effect a personality transfer.

### Identification

Each Motorola GSM device is labeled with a variety of identifying numbers. The following information describes the current identifying labels.

#### Mechanical Serial Number (MSN)

The Mechanical Serial Number (MSN) is an individual unit identity number and remains with the unit throughout the life of the unit.

The MSN can be used to log and track a unit on Motorola's Service Center Database.

The MSN is divided into 4 sections as shown in Figure 27.

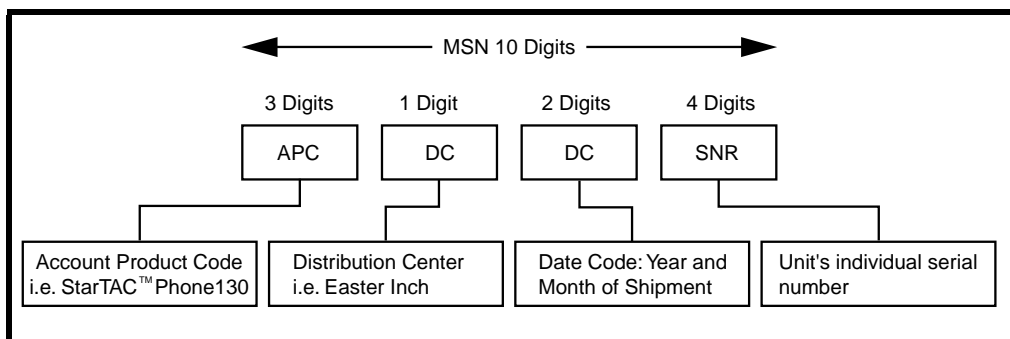
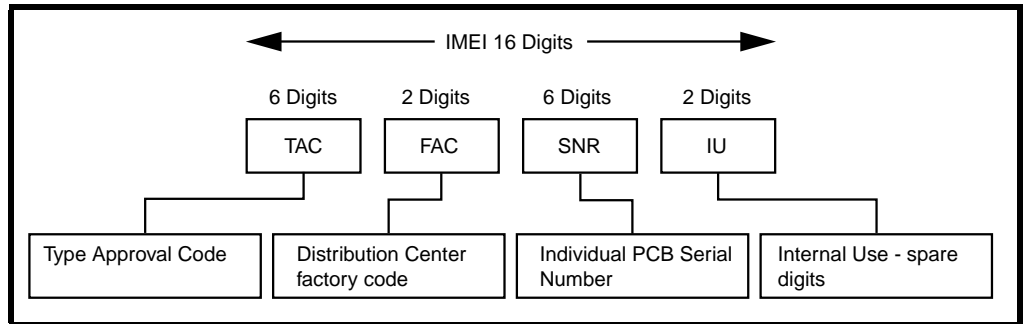

Figure 27. MSN Label breakdown

## International Mobile Station Equipment Identity (IMEI)

The International Mobile station Equipment Identity (IMEI) number is an individual number unique to the PCB and is stored within the unit's memory. The following diagram illustrates the various parts of this number.



000808o

**Figure 28. IMEI Label breakdown**

Other label number configurations present are:

- **TRANSCEIVER NUMBER:** Identifies the product type. Normally the SWF number. (i.e. V100).
- **PACKAGE NUMBER:** Identifies the equipment type, mode, and language in which the product is shipped.

# Troubleshooting

## Manual Test Mode

Motorola PF B89 telephones are equipped with a manual test mode capability. This allows service personnel to verify functionality and perform fault isolation by entering keypad commands.

To enter the manual test command mode, a GSM / DCS test SIM must be used.

1. Press **Ⓞ** to turn the phone OFF.
2. Remove the battery as described in the procedures.
3. Remove the customer's SIM card from the phone as described in the procedures.
4. Insert the test SIM into the SIM slot.
5. Replace the battery as described in the procedures.
6. Press **Ⓞ** to turn the phone ON.

## Manual Test Mode Commands

Table 2. Manual Test Commands

Key Sequence	Test Function/Name	Remarks
<Menu>048263*	Enter manual test mode	
"End" Key	Exit manual test mode	
54*	Suspend	Required for all Test Mode Operations
0*0*0	Select tone 0	
0*0*1	Select tone 1	
0*0*2	Select tone 2	
0*0*3	Select tone 3	
0*0*4	Select tone 4	
0*0*5	Select tone 5	
0*0*6	Select tone 6	
0*0*7	Select tone 7	
0*0*8	Select tone 8	
0*0*9	Select tone 9	
0*1*X	Disable tone X	
3*0*1	Enable vibrator	
3*0*0	Disable vibrator	
5*0*0	Set audio level 0	
5*0*1	Set audio level 1	
5*0*2	Set audio level 2	
5*0*3	Set audio level 3	
5*0*4	Set audio level 4	
5*0*5	Set audio level 5	
5*0*6	Set audio level 6	
5*0*7	Set audio level 7	

**Table 2. Manual Test Commands (Continued)**

Key Sequence	Test Function/Name	Remarks
5*0*8	Set audio level 8	
5*0*9	Set audio level 9	
5*0*10	Set audio level 10	
5*0*11	Set audio level 11	
5*0*12	Set audio level 12	
5*0*13	Set audio level 13	
5*0*14	Set audio level 14	
5*0*15	Set audio level 15	
6*2*2*0*0	Set Audio Path. Int Mic, IntSpk, RX unmute, TX unmute	
6*4*6*0*0	Set Audio Path. Boom Mic, Boom Spk, RX unmute, TX unmute	
10*0*3	Set band GSM 900	
10*0*4	Set band DCS 1800	
10*0*5	Set band PCS 1900	
10*0*6	Set dual band GSM 900 / 1800	
10*1*0	Read band	3= GSM 4= DCS 5= PCS 6 =GSM/DCS
18*0	Initialize non-volatile memory (Master Reset)	
18*1	Initialize Non-volatile memory (Master Clear)	
55*2*001	Test Display. All pixels ON	
55*2*000	Test Display. All pixels OFF	
55*2*002	Test Display. Checkerboard pattern A	
55*2*003	Test Display. Checkerboard pattern B	
55*2*004	Test Display. Border pixels ON	
*#06#	IMEI Check	No Test Mode Required
Phone Set up --> Phone Status --> Other Information	Flex Version / Technology / S-W Version / Readiness Status	No Test Mode Required

## Troubleshooting Chart

Table 3. PF A28 Telephone: Level 2 Troubleshooting Chart

SYMPTOM	PROBABLE CAUSE	VERIFICATION AND REMEDY
1. Telephone will not turn on or stay on.	a) Battery either discharged or defective.	Measure battery voltage across a 50 ohm (>1 Watt) load. If the battery voltage is <3.25 Vdc, recharge the battery using the appropriate battery charger. If the battery will not recharge, replace the battery. If battery is not at fault, proceed to b.
	b) Battery connectors open or misaligned.	Visually inspect the battery connectors on both the battery and the telephone. Realign and, if necessary, either replace the battery or refer to a Level 3 Service Center for the battery connector replacement. If battery connectors are not at fault, proceed to c.
	c) Transceiver board assembly defective.	Remove the transceiver board assembly. Substitute a known good assembly and temporarily reassemble the unit. Depress the PWR button; if unit turns on and stays on, disconnect the dc power source and reassemble the telephone with the new transceiver board assembly. Verify that the fault has been cleared. If the fault has not been cleared then proceed to d.
	d) Keypad PCB failure.	Replace the keypad PCB. Temporarily connect a +3.6 Vdc supply to the battery connectors. Depress the PWR button. If unit turns on and stays on, disconnect the dc power source and reassemble with the new keypad PCB.
2. Telephone exhibits poor reception or erratic operation such as calls frequently dropping or weak or distorted audio.	a) Antenna assembly defective.	Check to make sure that the antenna pin is properly connected to the transceiver board assembly. If connected properly, substitute a known good antenna. If the fault is still present, proceed to b.
	b) Transceiver board assembly defective.	Replace the transceiver board assembly (refer to 1c). Verify that the fault has been cleared and reassemble the unit with the new transceiver board assembly.
3. Display is erratic, or provides partial or no display.	a) Transceiver board connections faulty.	Remove rear housing from unit, check general condition of flexible printed cable (flex). If the flex is good, check that the flex connector is fully pressed down. If not, check connector to transceiver board connections. If faulty connector, replace the transceiver board assembly. If connector is not at fault, proceed to b.
	b) Display board connections faulty.	Remove the lens assembly as described in the procedures. Inspect the flex and the flex connector at the display board. Ensure the flex connector is fully seated. Replace or correct as required. If fault not cleared, proceed to c.
	c) LCD module defective.	Remove the LCD module as described in the procedures. Temporarily reassemble unit with a known good LCD module and verify proper operation. If fault is cleared, reassemble unit with the new LCD module. If fault not cleared, proceed to d.

**Table 3. PF A28 Telephone: Level 2 Troubleshooting Chart (Continued)**

SYMPTOM	PROBABLE CAUSE	VERIFICATION AND REMEDY
	d) Display board defective.	Remove display board as described in the procedures and replace with a known good display board. Temporarily reassemble unit and verify proper operation. If fault is cleared, reassemble unit with the new display board. If fault not cleared, proceed to e.
	e) Transceiver board assembly defective.	Replace the transceiver board assembly (refer to 1c). Verify that the fault has been cleared and reassemble the unit with the new transceiver board assembly.
4. Incoming call alert transducer audio distorted or volume is too low.	a) Faulty alert transducer.	Replace alert transducer. Temporarily reassemble the unit with the known good transducer and verify the fault has been cleared. If the transducer is not at fault, proceed to b.
	b) Faulty transceiver board assembly.	Replace the transceiver board assembly (refer to 1c). Verify that the fault has been cleared and reassemble the unit with the new transceiver board assembly.
5. Telephone transmit audio is weak. (usually indicated by called parties complaining of difficulty in hearing voice).	a) Microphone connections to the transceiver board assembly defective.	Gain access to the microphone as described in the procedures. Check connections. If connector is faulty proceed to c; if the connector is not at fault, proceed to b.
	b) Microphone defective.	Gain access to microphone. Disconnect and substitute a known good microphone. Place a call and verify improvement in transmit signal as heard by called party. If good, reassemble with new microphone. If microphone is not at fault, reinstall original microphone and proceed to c.
	c) Transceiver board assembly defective.	Replace the transceiver board assembly (refer to 1c). Verify that the fault has been cleared and reassemble the unit with the new transceiver board assembly.
6. Receive audio from earpiece speaker is weak or distorted.	a) Connections to or from transceiver board assembly defective.	Gain access to the transceiver board assembly as described in the procedures. Check flex and the flex connector from the display board to the transceiver board assembly. If flex is at fault, replace front housing assembly. If flex connector is at fault, proceed to d. If connection is not at fault, proceed to b.
	b) Connection to speaker faulty.	Remove the lens assembly as described in the procedures. Inspect the mating contacts on the speaker and on the display board. Repair contacts or replace lens assembly and/or display board as necessary. If speaker connection not at fault, proceed to c.
	c) Earpiece speaker defective.	Replace the lens assembly as described in the procedures. Temporarily reassemble unit and verify proper operation. If fault has not been cleared, replace original lens assembly and proceed to d.
	d) Antenna assembly defective.	Check to make sure the antenna is installed correctly. If the antenna is installed correctly, substitute a known good antenna assembly. If this does not clear the fault, reinstall the original antenna assembly and proceed to e.

Table 3. PF A28 Telephone: Level 1 and 2 Troubleshooting Chart (Continued)

SYMPTOM	PROBABLE CAUSE	VERIFICATION AND REMEDY
	e) Transceiver board assembly defective.	Replace the transceiver board assembly (refer to 1c). Verify that the fault has been cleared and reassemble with the new transceiver board assembly.
7. Telephone will not recognize or accept SIM card.	a) SIM card defective.	Check the SIM card contacts for dirt. Clean if necessary and check if fault has been cleared. If the contacts are clean, insert a known good SIM card into the telephone. Power up the unit and confirm that the card has been accepted. If the fault no longer exists, replace the defective SIM card. If the SIM card is not at fault, proceed to b.
	b) Connections between display board and transceiver board assembly faulty.	Refer to remedy 3a and 3b. If fault has not been cleared, proceed to c.
	c) Display board defective.	Replace display board with a known good one. Temporarily reassemble unit and verify proper operation. If fault has not been cleared, replace original display board and proceed to d.
	d) Transceiver board assembly defective.	Replace the transceiver board assembly (refer to 1c). Verify that the fault has been cleared and reassemble the unit with the new transceiver board assembly.
8. Phone does not sense when flip is opened or closed (usually indicated by inability to answer incoming calls by opening the flip, or inability to make outgoing calls).	a) Magnet in lens assembly missing or defective.	Replace lens assembly with known good one. Refer to the procedures. Place call to phone and verify ability to answer by opening flip. If fault is cleared, rebuild phone with new lens assembly. If fault is still present, replace original lens assembly and proceed to b.
	b) Reed switch on transceiver board defective.	Replace the transceiver board assembly (refer to 1c). Verify that the fault has been cleared and reassemble the unit with the new transceiver board assembly.
9. Vibrator feature not functioning.	a) Vibrator in flip assembly defective.	Replace display board with a known good one. Temporarily reassemble unit and verify proper operation. If fault has not been cleared, replace original display board and proceed to b.
	b) Connections between display board and transceiver board assembly faulty.	Refer to remedy 3a and 3b. If fault has not been cleared, proceed to c.
	c) Display board defective.	Replace display board with a known good one. Temporarily reassemble unit and verify proper operation. If fault has not been cleared, replace original display board and proceed to d.
	d) Transceiver board assembly defective.	Replace the transceiver board assembly (refer to 1c). Verify that the fault has been cleared and reassemble the unit with the new transceiver board assembly.
10. Internal Charger not working.	Faulty charger circuit on transceiver board assembly.	Test a selection of batteries in the rear pocket of the desktop charger. Check LED display for the charging indications. If these are charging properly, then the internal charger is at fault. Replace the transceiver board assembly (refer to 1c). Verify that the fault has been cleared and reassemble the unit with the new transceiver board assembly.

**Table 3. PF A28 Telephone: Level 1 and 2 Troubleshooting Chart (Continued)**

SYMPTOM	PROBABLE CAUSE	VERIFICATION AND REMEDY
11. Real Time Clock resetting when standard battery is removed.	Lithium button cell in the display board may be depleted.	Replace the RTC battery as described in the procedures. Check RTC time does not reset.
12. No or weak audio when using headset.	a) Headset not fully pushed home.	Ensure the headset plug is fully seated in the jack socket.
	b) Faulty jack socket on transceiver board assembly.	Replace the transceiver board assembly (refer to 1c). Verify that the fault has been cleared and reassemble the unit with the new transceiver board assembly.

### Programming: Software Upgrade and Flexing

Contact your local technical support engineer for information about equipment and procedures for flashing and flexing.



---

## Part Number Charts

The following charts are provided as a reference for the parts associated with PF B89 telephones.

### Related Publications

V.Series™ 66 Wireless Phone User Guide, English	6809435A60
V.Series™ 66 Wireless Phone Reference Guide, English	6809435A64

### Exploded View Diagram

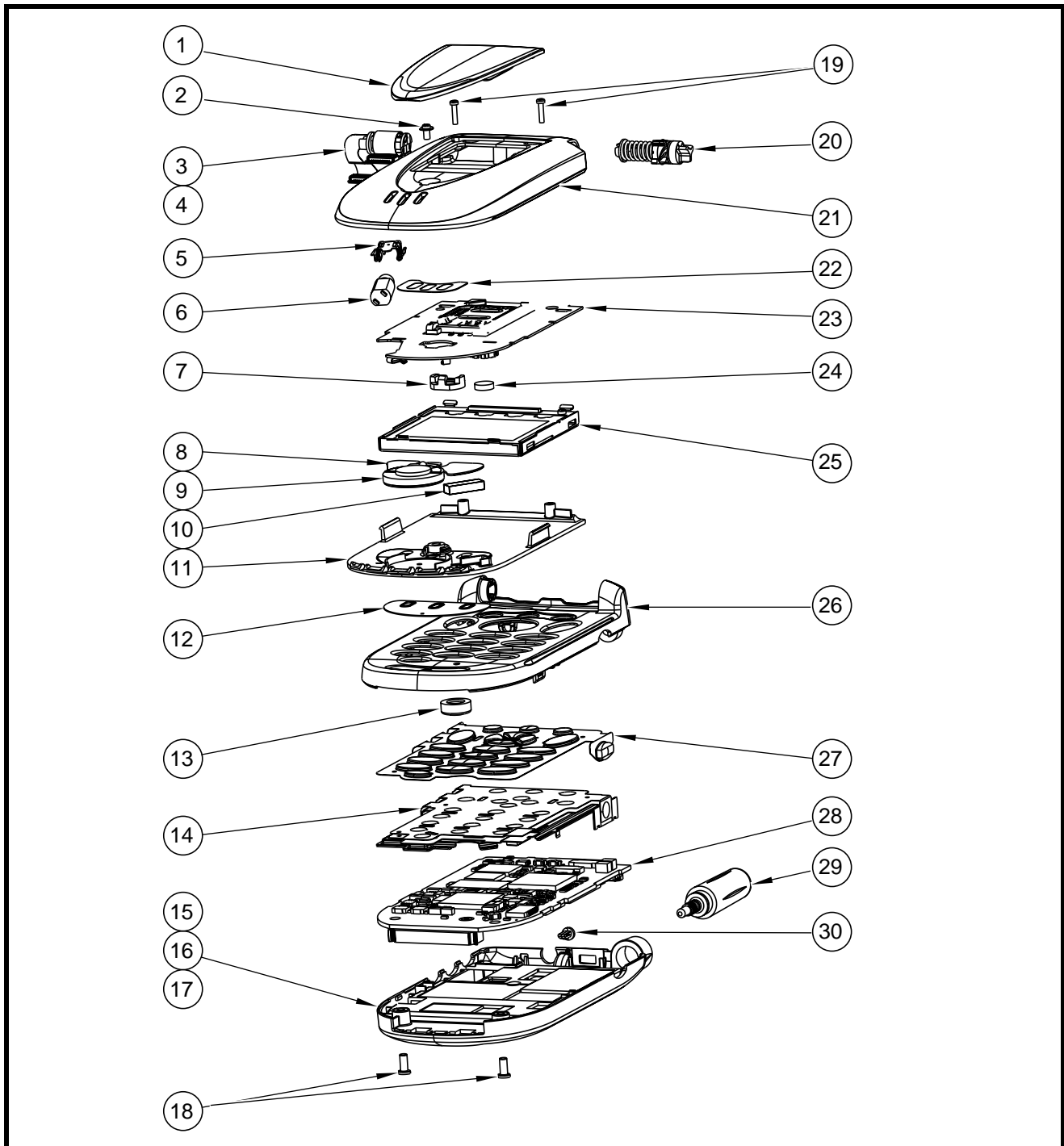

010245o

Figure 29. Exploded view diagram

## Exploded View Parts List

Table 4. Exploded View Parts List

Item Number	Motorola Part Number	Description
1	See Table 6	Insert, bezel, flip
2	0389893K01	Screw, lens, T-4
3	8489067K01	Flex
4	4787967L01	Flex shaft
5	Note 1	Vibrator bracket
6	Note 1	Vibrator
7	5589044L01	Bezel clip
8	3588723L01	Lens screen
9	5087975K02	Speaker
10	5504765Z08	Magnet
11	See Table 5	Lens
12	0588380L01	Speaker grommet
13	5088625L01	Microphone assembly
14	Note 2	Keypad PCB assembly
15	See Table 5	Rear housing assembly

Item Number	Motorola Part Number	Description
16	Note 3	Battery latch
17	Note 3	Battery latch spring
18	0389896K01	Screw, housing, T-6 (2)
19	0389893K01	Screw, lens, T-4 (2)
20	5504765Z08	Hinge mechanism
21	See Table 5	Flip housing
22	3588666L01	Flip screen
23	0187526L01	Display board assembly
24	6087603L01	RTC battery
25	7287676L01	LCD module
26	See Table 5	Front housing assembly
27	See Table 5	Keypad
28	See Note 3	Transceiver board assembly
29	8589150K01	Antenna
30	6189145K01	Light guide, indicator

- Notes:**
1. Order next higher assembly, Item 23.
  2. Order next higher assembly, Item 28.
  3. Order next higher assembly, Item 15.
  3. Not available as spares in EMEA Service markets.



*There is a danger of explosion if the Lithium Ion battery pack is replaced incorrectly. Replace only with the same type of battery or equivalent as recommended by the battery manufacturer. Dispose of used batteries according to the manufacturer's instructions.*

## Model-dependent Part Numbers

**Table 5. Model-dependent Part Numbers**

Item Number	Part Description	Part Number
11	Lens, gold	6189891K01
11	Lens, silver	6189891K02
15	Rear housing assembly, Silver	1587999L02
15	Rear housing assembly, Radar Blue	1587999L03
15	Rear housing assembly, Holographic Purple	1587999L04
21	Flip housing, Silver	1589255K03
21	Flip housing, Radar Blue	1589255K05
21	Flip housing, Holographic Purple	1589255K06
26	Front housing assembly, Silver	1587998L02
26	Front housing assembly, Radar Blue	1587998L03
26	Front housing assembly, Holographic Purple	1587998L04
27	Keypad, gold	3889139K01
27	Keypad, CKE, gold	3889139K02
27	Keypad, Taiwan, gold	3889139K03
27	Keypad, silver	3889139K04
27	Keypad, CKE, silver	3889139K05
27	Keypad, Taiwan, silver	3889139K06

## Accessories

**Table 6. Accessories**

Part Description	Part Number
Insert, bezel, flip, Café Latte	SYN9076
Insert, bezel, flip, Smoky Silver	SYN9077
Insert, bezel, flip, Sage	SYN9114
Insert, bezel, flip, Onyx	SYN9115
Insert, bezel, flip, Thunderstorm	SYN9116
Insert, bezel, flip, Mermaid Green	SYN9117
Insert, bezel, flip, Holographic Purple	SYN9118
Battery, Lilon 500 mAh (4 mm), English Label, Silver	SNN5609
Battery, Lilon 500 mAh (4 mm), Chinese Label, Silver	SNN5610
Battery, Lilon 500 mAh (4 mm), English Label, Radar Blue	SNN5611
Battery, Lilon 500 mAh (4 mm), Chinese Label, Radar Blue	SNN5612
Battery, Lilon 1100 mAh (8 mm), English Label, Silver	SNN5617
Battery, Lilon 1100 mAh (8 mm), Chinese Label, Silver	SNN5618
Battery, Lilon 1100 mAh (8 mm), English Label, Radar Blue	SNN5619
Battery, Lilon 1100 mAh (8 mm), Chinese Label, Radar Blue	SNN5620
Travel charger, mid-rate, U.S. flip, Klaus adapter compatible	SPN4940

**Table 6. Accessories (Continued)**

<b>Part Description</b>	<b>Part Number</b>
Travel charger, mid-rate, Argentina, fixed adapter	SPN4739
Travel charger, mid-rate, China, Klaus adapter compatible	SPN4741
Travel charger, mid-rate, Hong Kong, fixed adapter	SPN4744
Travel charger, mid-rate, Korea, Klaus adapter compatible	SPN4756
Travel charger, mid-rate, Brazil, Klaus adapter compatible	SPN4977
Klaus adapter, Euro Plug (Default)	SYN7456
Klaus adapter, U.K. Plug (meets BSI)	SYN7455
Klaus adapter, Aus / NZ Plug	SYN8127
Klaus adapter, Indian Plug (5 Amp)	SYN7461
Klaus adapter, Korean Plug	SYN7460
Travel charger, mid-rate, single voltage, fixed plug, economy, U.S.	SPN4808
Travel charger, mid-rate, single voltage, fixed plug, economy, China	SPN4742
Travel charger, mid-rate, single voltage, fixed plug, economy, Euro	SPN4734
Travel charger, mid-rate, single voltage, fixed plug, economy, U.K.	SPN4745
Desk charger, dual pocket, data passthrough, English label, black	SPN4970
Desk charger, dual pocket, data passthrough, Chinese label, black	SPN4971
Vehicle power adapter (VPA)	SYN7818
Leather pouch	CHYN4250
Leather case, functional with flip	SYN8810
Leather case, functional without flip	SYN8811
Hands free car kit, easy install	SYN8597
Headset (plastic bag)	SYN8390
Headset, boom microphone	SYN8146
Headset, retractable	SYN8284
Headset, send-end button	SYN8419
Headset, FM stereo radio	SYN8609
Headset, Silver	AAYN4264
Data cable, USB kit, CDROM	S8951
Data cable, multi-connect serial kit, CDROM	S8952
Data cable, multi-connect Palm kit, CDROM	S8953
Data cable, USB	SKN6311
Data cable, RS232	SKN6315
Data head, RS232	SYN0279



---

# Index

## A

alert settings 12  
antenna, removing and replacing 19

## B

battery  
    function 13  
    gauge 13  
    removing 16  
    replacing 17  
battery door  
    removing 16

## C

call forwarding 8  
caller ID 8  
Canadian Interference-Causing Equipment regulations 1  
changes  
    product 1  
commands, manual test mode 39  
controls 9  
conventions 3  
copyrights  
    computer software 2

## D

disassembly 16

## E

exploded view diagram 46  
exploded view parts list 47

## F

FCC rules 1  
features 6  
    call forwarding 8  
    caller ID 8  
    text entry 8  
    voice recognition 7  
    Wireless Access Protocol (WAP) 7  
flip assembly, removing and replacing 33

## I

identification 37

international mobile station equipment identity 38  
mechanical serial number 37  
product 1

IMEI 38

Introduction 1

## K

keypad PCB, removing and replacing 24  
keypad, removing and replacing 26

## L

light guide, removing and replacing 20  
liquid crystal display (LCD) 10

## M

manual test mode 39  
microphone, removing and replacing 25  
MSN 37

## N

names  
    product 1

## O

overview 6

## P

part numbers  
    accessories 48  
parts 45  
    exploded view diagram 46  
    exploded view parts list 47  
product  
    changes 1  
    identification 1  
    names 1  
publications, related 45

## R

rear housing  
    removing 20  
regulatory agency compliance 1  
related publications 45  
removing  
    antenna 19  
    battery 13, 16  
    battery door 16

---

- flip assembly 33
- keypad 26
- keypad PCB 24
- light guide 20
- microphone 25
- rear housing 20
- SIM card 17
- replacement parts
  - ordering 4
- replacing
  - antenna 19
  - battery 16
  - flip assembly 33
  - keypad 26
  - keypad PCB 24
  - light guide 20
  - microphone 25
- revisions
  - service manual 3

**S**

- serial number
  - mechanical 37
- service manual
  - about 2
  - revisions 3
  - scope 2
- service policy 3
  - customer support 4
  - out of box failure 3
  - product support 3
  - replacement parts 4
- shut down
  - upon battery removal 13
- SIM card 37
  - personality transfer 37
  - removing 17
  - replacing 18
- specifications 5
- support
  - customer 4
  - product 3

**T**

- text entry 8
- tools and test equipment 15
- troubleshooting 39
  - manual test mode 39
  - manual test mode commands 39

**U**

- user interface diagrams 12

**V**

- voice recognition 7

**W**

- warranty service 3
- wireless access protocol (WAP) 7





MOTOROLA, the Stylized M Logo, and all other trademarks indicated as such herein are trademarks of Motorola, Inc.

® Reg. U.S. Pat. & Tm. Off.

TrueSync is a trademark of Starfish, Inc., a wholly owned independent subsidiary of Motorola, Inc.

All other product or service names are the property of their respective owners.

© 2001 Motorola, Inc.

All rights reserved.

Personal Communications Sector,

1500 Gateway Blvd.

Boynton Beach, FL 33426-8292

Printed in U.S.A. 05/01



6881038B20-O

# V.66 - RF SCHEMATICS

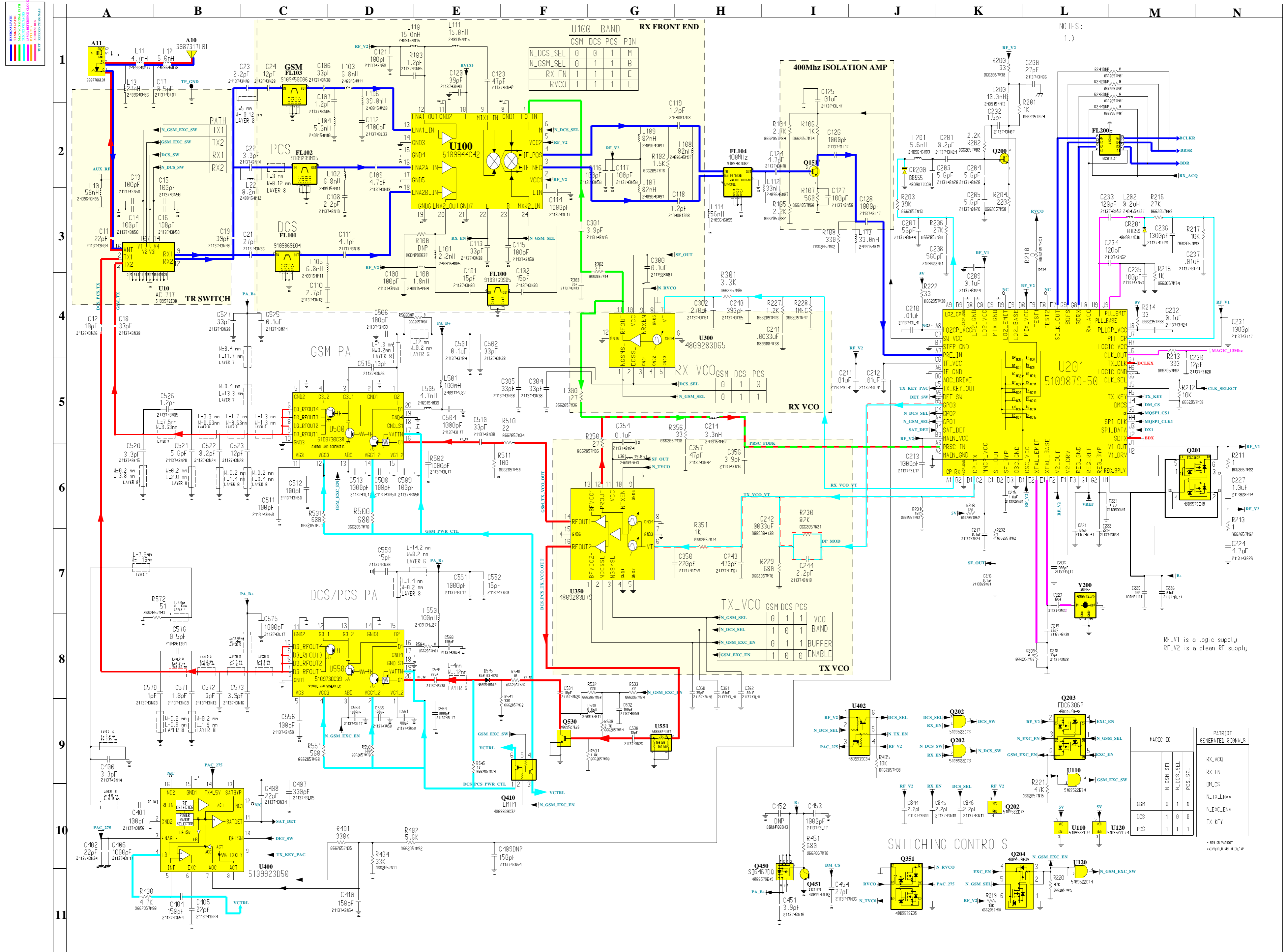

# V66 - AL SCHEMATICS

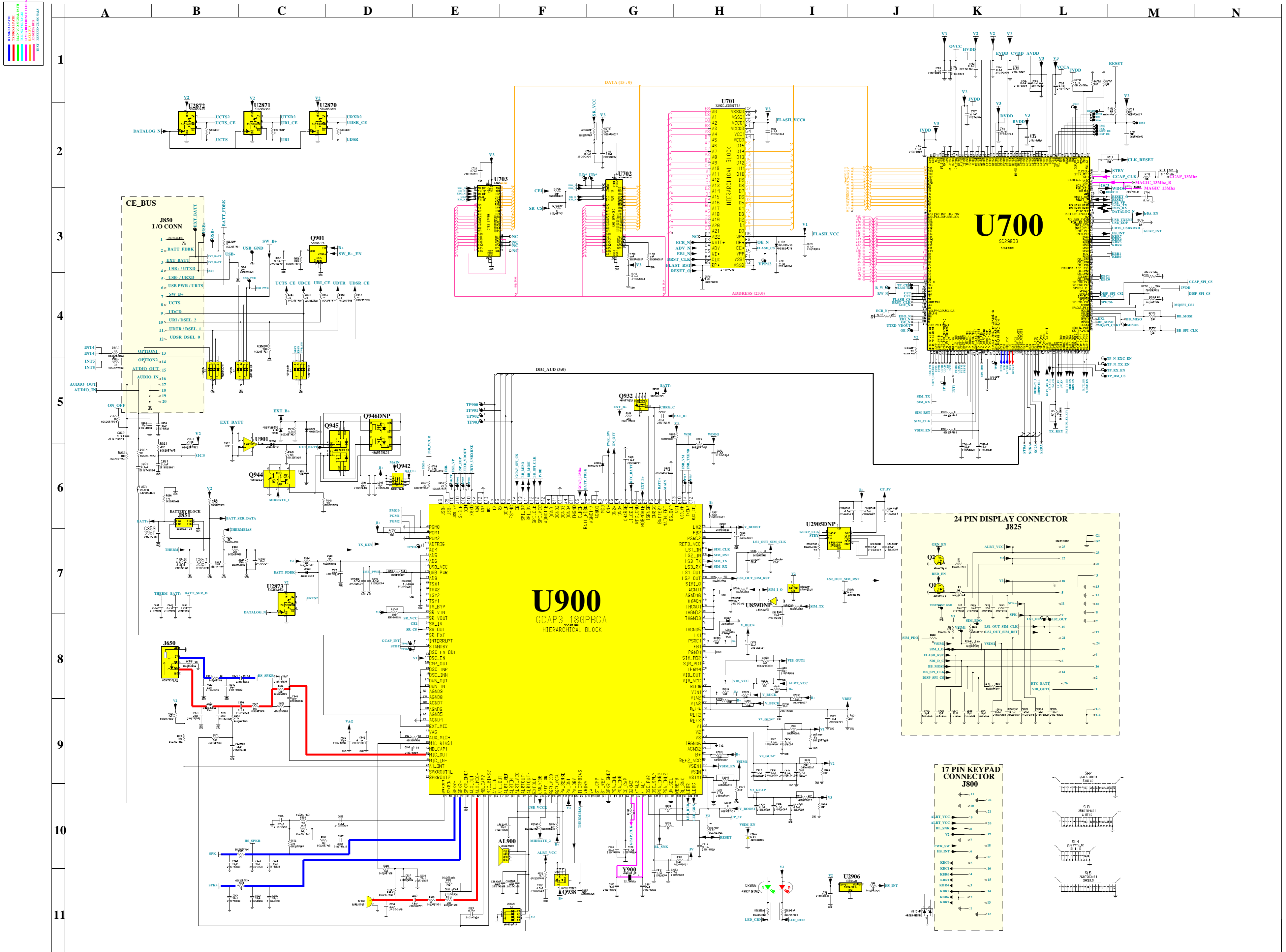

# V.66 - BLOCK DIAGRAM - PAGE 1/2

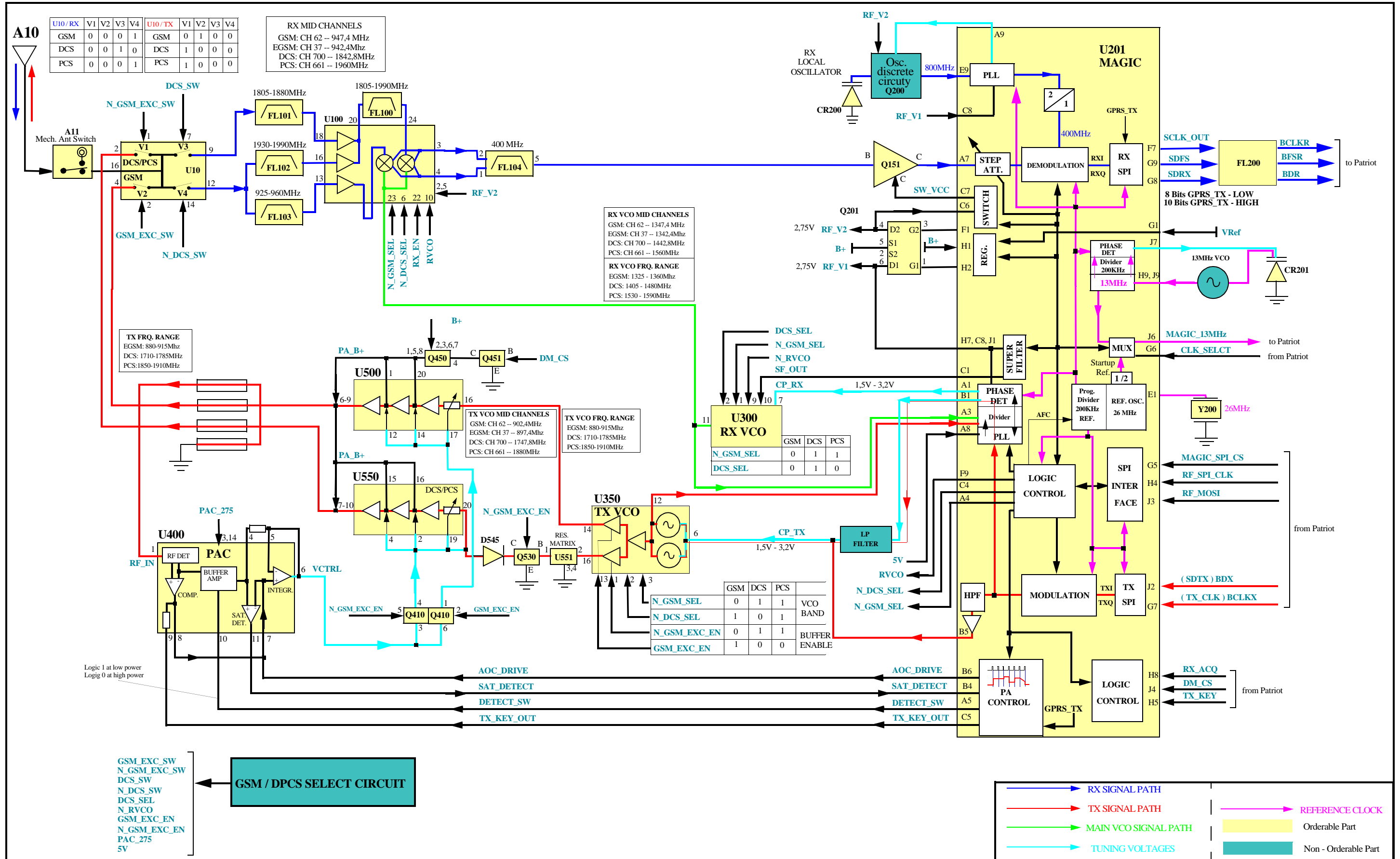

# V.66 - BLOCK DIAGRAM - PAGE 2/2

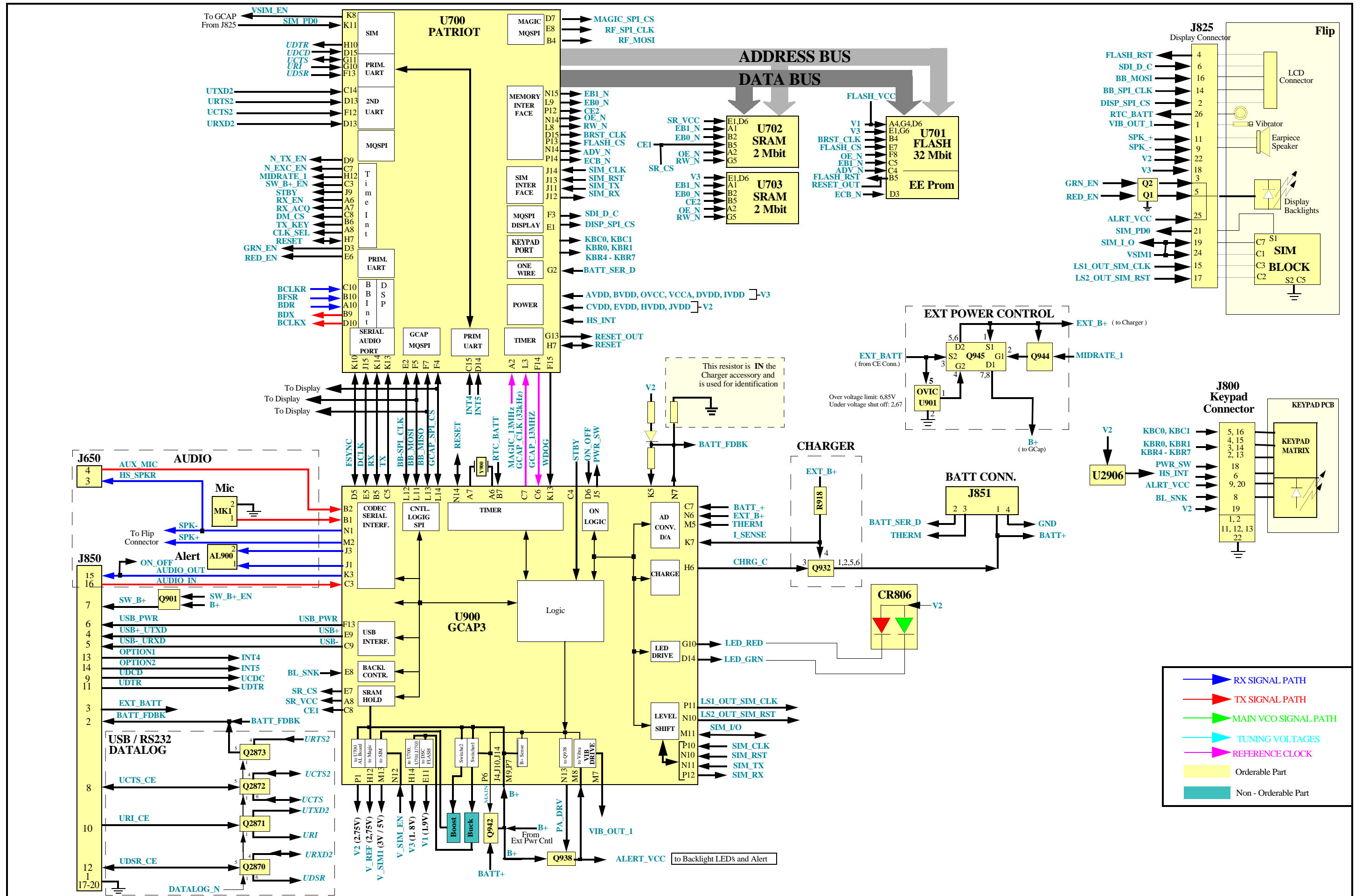

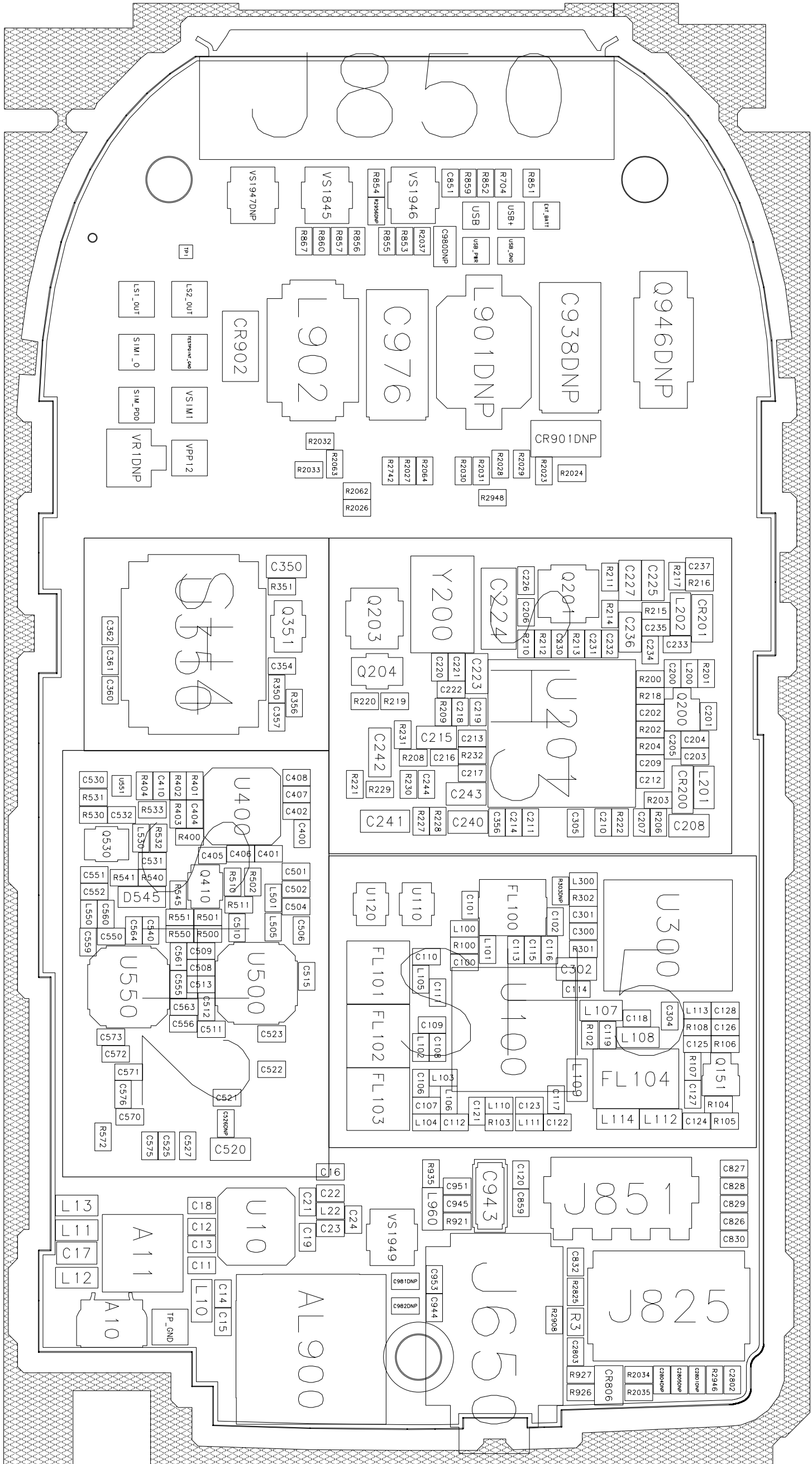





# V.66 - FRONT HOUSING SCHEMATIC

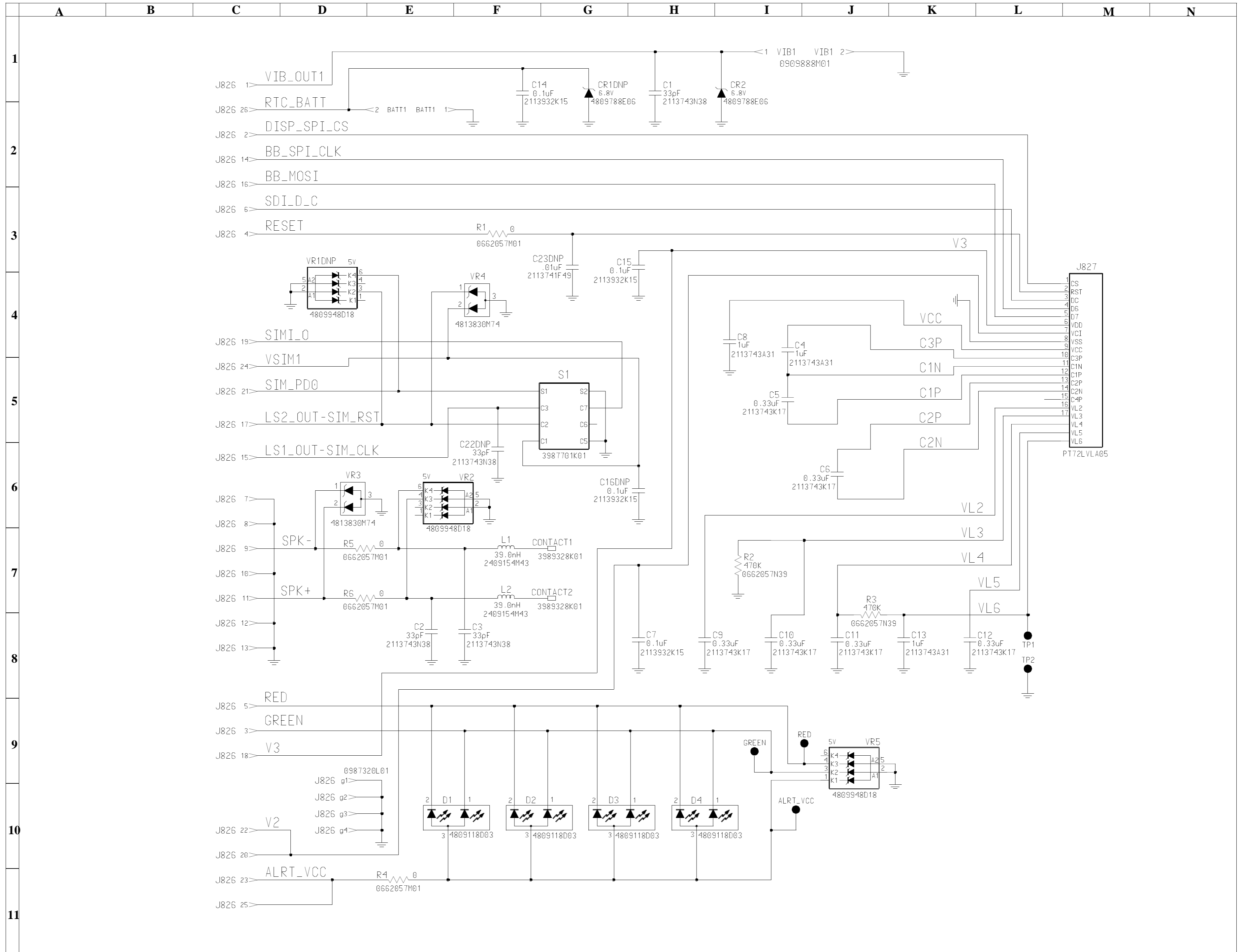

# V66 - FLIP SCHEMATIC

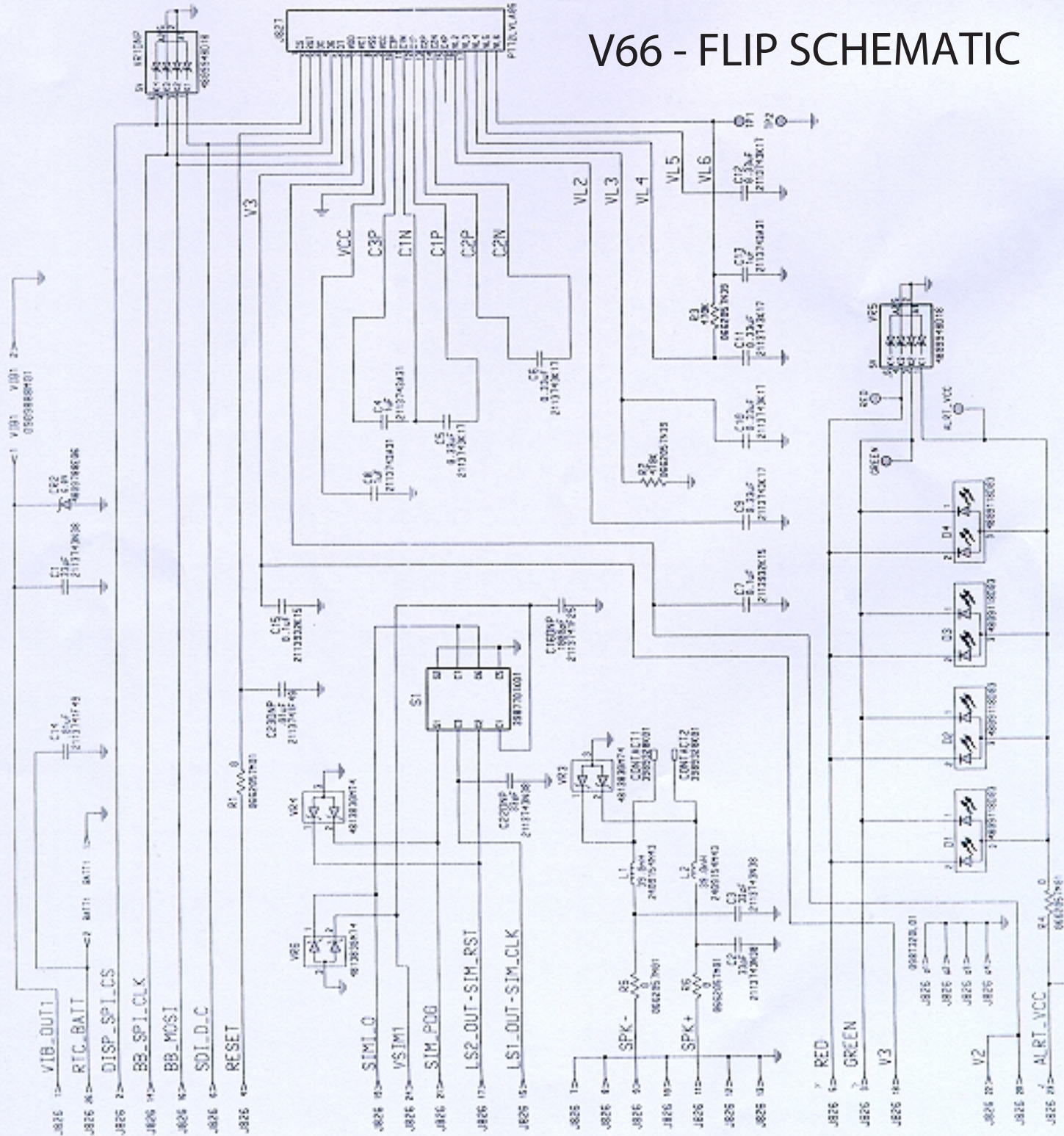

# V.66 - SIGNAL FLOW - PAGE 1/2

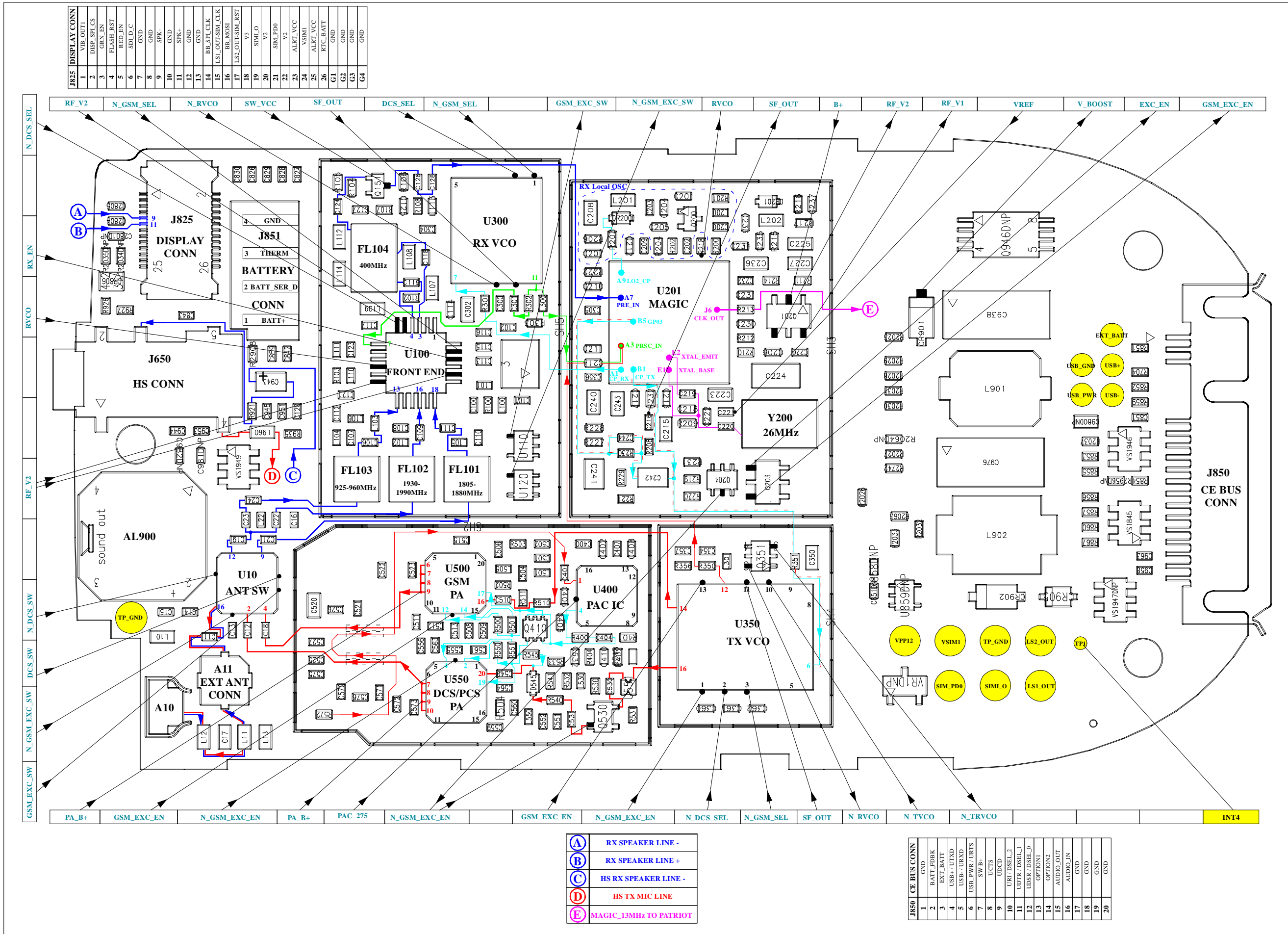

J825 DISPLAY CONN	
1	VIB_OUT1
2	DISP_SPL_CS
3	GRN_EN
4	FLASH_RST
5	RED_EN
6	SDI_D_C
7	GND
8	GND
9	SPK-
10	GND
11	SPK+
12	GND
13	GND
14	BB_SPL_CLK
15	LS1_OUT_SIM_CLK
16	BB_MOSI
17	LS2_OUT_SIM_RST
18	V3
19	SIM_I/O
20	V2
21	SIM_PD0
22	V2
23	ALERT_VCC
24	VSIM1
25	ALERT_VCC
26	RTC_BATT
G1	GND
G2	GND
G3	GND
G4	GND

- A RX SPEAKER LINE -
- B RX SPEAKER LINE +
- C HS RX SPEAKER LINE -
- D HS TX MIC LINE
- E MAGIC\_13MHz TO PATRIOT

J850 CE BUS CONN	
1	GND
2	BATT_FDRK
3	EXT_BATT
4	USB-/UTXD
5	USB-/UTXD
6	USB-PWR/URTS
7	SW B+
8	UCTS
9	UDCD
10	UR1_DSEL2
11	UDTR/DSEL_1
12	CDSR/DSEL_0
13	OPTION1
14	OPTION2
15	AUDIO_OUT
16	AUDIO_IN
17	GND
18	GND
19	GND
20	GND

# V.66 - SIGNAL FLOW - PAGE 2/2

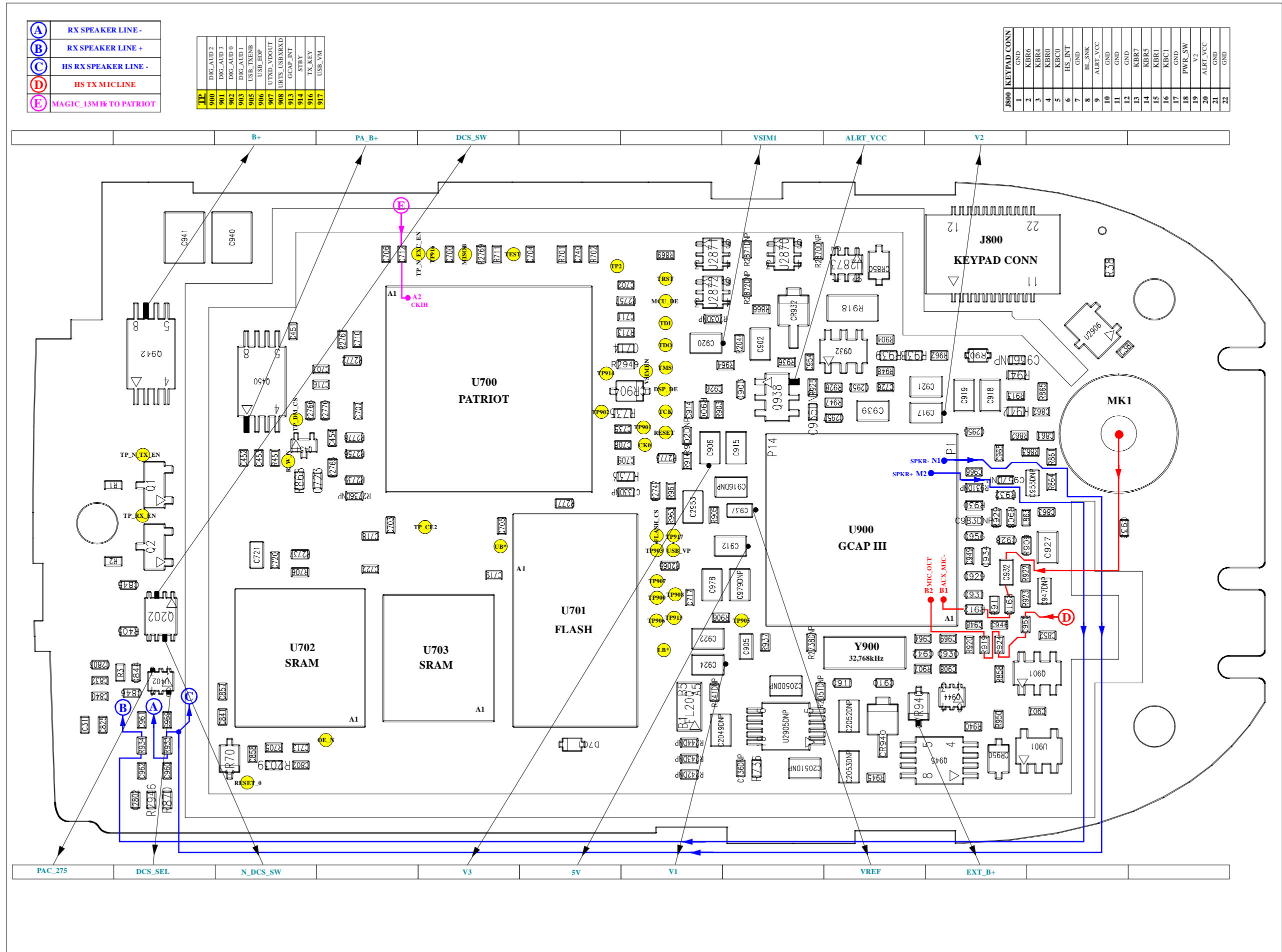

## V66 Level 3 Parts List

TRANSCEIVER TOP			TRANSCEIVER BOTTOM		
Ref	Part Number	Description	Ref	Part Number	Description
CR701	4809788E06	DIODE ZENER 6.8V UDZ6.8B	A10	3987317L01	CONTACT, ANTENNA SAPPHIRE
CR850	4809948D42	DIODE SCHOTTKY RB751V-40	A11	0987786L01	CONNECTOR RF SAPPHIRE
CR903	4809924D18	DIODE HIGH VOLTAGE/SW RB520S	AL900	5062841B01	ALERT REFLOWABLE 2.5, 3.2X8.5X
CR904	4809788E06	DIODE ZENER 6.8V UDZ6.8B	CR200	4809877C09	DIODE VARACTOR BB555 ESC
CR932	4809653F07	RECT SCHTTKY 1A MBRM120ET3	CR201	4809877C10	DIODE VARACTOR BB659 ESC
CR940	4809653F07	RECT SCHTTKY 1A MBRM120ET3	CR806	4809118D02	LED BICOLOR LNJ115W8POMT
CR950	4809948D42	DIODE SCHOTTKY RB751V-40	CR901	4813833B10	DIODE SCHOTTKY .5A 30V
D701	4809924D18	DIODE HIGH VOLTAGE/SW RB520S	CR902	4813833B10	DIODE SCHOTTKY .5A 30V
FL200	9188695K04	FLTR RCR 13 MHZ 1.0X2.5MM CSP	CR905	4809788E06	DIODE ZENER 6.8V UDZ6.8B
J800	0987817K01	RECP BTB 0.5P 1.5 STACK SMD	D545	4809948D39	DIODE PIN BAR63-02W ESC
Q1	4809579E16	TSTR MOSFET N-CHAN TN0200T	or	4809948D12	DIODE PIN BAR63-02W ESC
Q2	4809579E16	TSTR MOSFET N-CHAN TN0200T	D851		DNP
Q202	5109522E73	IC 2.5NS DUALINPUT & GATE 8PIN	D852		DNP
Q450	4809579E49	FET P CHAN SI6467DQT1 TSSOP8	D853		DNP
Q451	4809940E02	TSTR DIG NPN DTC114YE	FL100	9103769S05	CERAMIC FILTER 1805-1990 MHZ
Q901	5109817F45	IC CURRENT LIMIT SWITCH TSOP 6	FL101	9109069E04	FLTR SAW BP 1842MHZ 3X3MM SMD
Q932	4809579E29	TSTR FET P-CHAN SI3443DV 6TSOP	FL102	9109239M12	FLTR SAW BP 1960MHZ 3X3MM SMD
Q938	4809579E29	TSTR FET P-CHAN SI3443DV 6TSOP	FL103	9109450C06	FLTR SAW BP 942MHZ 3X3MM SMD
Q942	4809579E49	FET P CHAN SI6467DQT1 TSSOP8	FL104	9109487U02	FLTR SAW BP 400MHZ SMD
Q944	4809939C39	TRANS DUAL NPN/PNP EMT6	J650	0987837L04	CONN JACK
Q945	4887611L01	FET, P-CHAN, IRF7555, MICRO-8	J825	0987320L01	RECP Z AXIS 26 PINS
U402	4809939C34	TSTR DUAL PNP EMB10T2R EMT6	J850	0987636K06	CONN I/O
U700	5195015D07	IC GSM CODE RELEASE 3	J851	3988737L01	CONT BATT
U702	5109509A36	IC SRAM 256KX16 KM616FR4010ZI	Q151	4809527E30	TSTR NPN RF NE68719 SC90
U703	5109509A39	IC SRAM 128KX16	Q200	4809527E24	TSTR NPN RF MRF949LT1 SC-90
U900	5109879E83	IC BICMOS GCAP3 V 2.6 179 BGA	Q201	4809579E48	TSTR FET DUAL P CH FDC6306P
U901	5109731C32	OVIC VOLT COMPARATOR MC33645	Q203	4809579E48	TSTR FET DUAL P CH FDC6306P
U2870	5162852A59	IC CMOS ANALOG SWITCH SPDT	Q204	4809579E39	TSTR FET DUAL FDG6323L SC70-6
U2871	5162852A59	IC CMOS ANALOG SWITCH SPDT	Q351	4809579E35	TSTR FET DUAL N-CHAN FDG3601N
U2872	5162852A59	IC CMOS ANALOG SWITCH SPDT	Q410	4809939C32	TSTR DUAL NPN EMH4T2R
U2873	5162852A59	IC CMOS ANALOG SWITCH SPDT	Q530	4809527E26	TSTR NPN RF 25C5081 SOT343
U2905	DNP		Q946		DNP
U2906	5109817F16	IC DECT HALL EFECT MOT82 SOT23	U400	5109879E66	IC BICMOS - MAGIC
VR940	4809788E06	DIODE ZENER 6.8V UDZ6.8B	U350	5109923D50	IC PAC
Y900	4809995L05	XTAL QUARTZ 32.768KHZ CC4V-T1	U500	5109730C47	IC GAAS - PA
			U550	5109730C48	IC GAAS - PA
			U300	4809283D80	IC OCS - VCO