



**MOTOROLA**

Level 1 and 2 Service Manual

6809501A48-A

# V3m

## Digital Wireless Telephone



CDMA 1900 MHz, CDMA 800 MHz

MOTOROLA and the Stylized M Logo are registered in the US Patent & Trademark Office.  
All other product or service names are the property of their respective owners.

The Bluetooth trademarks are owned by their proprietor and used by Motorola, Inc. under license.  
© Motorola, Inc. 2006.  
All rights reserved.

Mobile Devices Business,  
Sawgrass International Concourse  
789 International Parkway  
Room S2C  
Sunrise, FL 33325-6220

---

## Contents

<b>Introduction</b> .....	<b>5</b>
Product Identification .....	5
Product Names .....	5
Regulatory Agency Compliance .....	5
Computer Program Copyrights .....	6
About this Service Manual .....	6
Warranty Service Policy .....	7
Parts Replacement .....	7
<b>Specifications</b> .....	<b>9</b>
<b>Product Overview</b> .....	<b>10</b>
Features .....	10
<b>General Operation</b> .....	<b>12</b>
Controls, Indicators, and Input / Output (I/O) Connections .....	12
User Interface Menu Structure .....	15
Alert Settings .....	16
Battery Function .....	16
Operation .....	16
<b>Tools and Test Equipment</b> .....	<b>17</b>
<b>Disassembly</b> .....	<b>18</b>
Removing and Replacing the Battery Cover and Battery .....	18
Removing and Replacing the Memory Card .....	20
Removing and Replacing the Rear Housing .....	21
Removing and Replacing the Antenna .....	25
Removing and Replacing the Transceiver Board Assembly .....	27
Removing and Replacing the Flip Assembly Cover and CLI Lens .....	28
Removing and Replacing the Camera Assembly .....	37
Removing and Replacing the Display Module Assembly .....	38
<b>Removing and Replacing the Hinge Assembly</b> .....	<b>40</b>
<b>Phone Identification</b> .....	<b>56</b>
Personality Transfer .....	56
Identification .....	56
<b>Troubleshooting Chart</b> .....	<b>57</b>
Programming: Software Upgrade and Flexing .....	59
Part Numbers .....	59
Related Publications .....	59
Exploded View Diagram .....	60
Exploded View Parts List .....	61
Accessories .....	63



## Introduction

Motorola® Inc. maintains a worldwide organization that is dedicated to provide responsive, full-service customer support. Motorola products are serviced by an international network of company-operated product-care centers as well as authorized independent service firms.

Available on a contract basis, Motorola Inc. offers comprehensive maintenance and installation programs that enable customers to meet requirements for reliable, continuous communications.

To learn more about the wide range of Motorola service programs, contact your local Motorola products representative or the nearest Customer Service Manager.

## Product Identification

Motorola products are identified by the model number on the housing. Use the entire model number when inquiring about the product. Numbers are also assigned to chassis and kits. Use these numbers when requesting information or ordering replacement parts.

## Product Names

Product names are subject to change without notice. Some product names, as well as some frequency bands, are available only in certain markets.

## Regulatory Agency Compliance

This device complies with Part 15 of the FCC Rules. Operation is subject to the following conditions:

- This device may not cause any harmful interference
- This device must accept interference received, including interference that may cause undesired operation

This class B device also complies with all requirements of the Canadian Interference-Causing Equipment Regulations (ICES-003).

Cet appareil numérique de la classe B respecte toutes les exigences du Règlement sur le matériel brouilleur du Canada.

---

## Computer Program Copyrights

The Motorola products described in this manual may include Motorola computer programs stored in semiconductor memories or other media that are copyrighted with all rights reserved worldwide to Motorola. Laws in the United States and other countries preserve for Motorola, Inc. certain exclusive rights to the copyrighted computer programs, including the exclusive right to copy, reproduce, modify, decompile, disassemble, and reverse-engineer the Motorola computer programs in any manner or form without Motorola's prior written consent. Furthermore, the purchase of Motorola products shall not be deemed to grant either directly or by implication, estoppel, or otherwise, any license or rights under the copyrights, patents, or patent applications of Motorola, except for a nonexclusive license to use the Motorola product and the Motorola computer programs with the Motorola product.

## About this Service Manual

Using this service manual and the suggestions contained in it assures proper installation, operation, and maintenance. Refer questions about this manual to the nearest Customer Service Manager.

### Audience

This service manual aids service personnel in testing and repairing V3m telephones. Service personnel should be familiar with electronic assembly, testing, and troubleshooting methods, and with the operation and use of associated test equipment.

Use of this manual assures proper installation, operation, and maintenance of Motorola products and equipment. It contains all service information required for the equipment described and is current as of the printing date.

### Scope

This manual provides basic information relating to V3m telephones, and also to provides procedures and processes for repairing the units at Level 1 and 2 service centers including:

- Unit swap out
- Repairing of mechanical faults
- Basic modular troubleshooting
- Testing and verification of unit functionality
- Initiate warranty claims and send faulty modules to Level 3 or 4 repair centers

---

## Conventions

The following special characters and typefaces are used in this manual to emphasize certain types of information.



*Note: Emphasizes additional information pertinent to the subject matter.*



*Caution: Emphasizes information about actions that may result in equipment damage.*



*Warning: Emphasizes information about actions that may result in personal injury.*

## Warranty Service Policy

The product is sold with the standard 12-month warranty terms and conditions. Accidental damage, misuse, and extended warranties offered by retailers are not supported under warranty. Non warranty repairs are available at agreed fixed repair prices.

### Out-of-Box Failure Policy

The standard out of box failure criteria applies. Customer units that fail very early on after the date of sale, are to be returned to Manufacturing for root cause analysis, to guard against epidemic criteria. Manufacturing will bear the costs of early life failure.

### Product Support

Customer's original units will be repaired but not refurbished as standard. Appointed Motorola Service Hubs will perform warranty and non-warranty field service for level 2 (assemblies) and level 3 (limited PCB component). The Motorola High Technology Centers will perform level 4 (full component) repairs.

### Customer Support

Customer support is available through dedicated Call Centers and in-country help desks. Product Service training is available through the local Motorola Support Center.

## Parts Replacement

When ordering replacement parts or equipment, include the Motorola part number and description used in the service manual or supplement.

When the Motorola part number of a component is not known, use the product model number or other related major assembly along with a description of the related major assembly and of the component in question.

In the U.S.A., to contact Motorola, Inc. on your TTY, call: 800-793-7834

---

## Accessories and Aftermarket Division (AAD)

Order replacement parts, test equipment, and manuals from AAD.

### U.S.A.

Phone: 800-814-0601

FAX: 800-622-6210

Website: <http://businessonline.motorola.com>

### Outside U.S.A.

Phone: 847-538-8023

FAX: 847-576-3023

### EMEA

Phone: +49 461 803 1404

Website: <http://emeaonline.motorola.com>

### Asia

Phone: +65 648 62995

Website: <http://asiaonline.motorola.com>



## Specifications

General Function	Specification
Frequency Range 1900 MHz PCS	1931.250 -1988.750 MHz Rx 1851.250 -1908.750 MHz Tx
Frequency Range 800 MHz CDMA	869.70 - 893.31 Rx (CDMA) 824.70 - 848.31 Tx (CDMA)
Channel Spacing	50 kHz PCS 30 kHz CDMA
Channels	1150 PCS 788 CDMA 800
Modulation	1M25F9W (1.25 MHz bandwidth) CDMA 3G1XRTT (1.25 MHz bandwidth) CDMA-1X
Duplex Spacing	80 MHz PCS 45 MHz CDMA 800
Frequency Stability	± 150 Hz (CDMA)
Power Supply	3.6V Li Ion 740 mAh battery
Average Transmit Current	310 mA at +13dBm)
Average Stand-by Current (slot cycle 1)	4.18 mA
Dimensions (with 740 mAh Li Ion battery)	53mm x 98mm x 14.5mm
Size (Volume)	67 cc
Weight	≤115g (3.88 oz) with battery
Operating Temperature Range	-30° C to +60° C (-22° F to +140° F)
Humidity	80% Relative Humidity at 50° C (122° F)
Battery Life, 740 mAh Li Ion Battery	Digital Talk Time: 180 Minutes for 740mAh and (IS95/IS2000 Cell/PCS, CDG Suburban Profile with 40% VAF ~ + 110.6dBm)  Digital Standby Time: 195 Hours (IS95/IS2000 Cell/PCS Slot Cycle 1)
	All talk and standby times are approximate and depend on network configuration, signal strength, and features selected.

Transmitter Function	Specification
RF Power Output	0.30 watts +25 dBm into 50 ohms (CDMA/PCS nominal)
Spurious Emissions	- 18.5 dBm (max) from 0.03 to 19 GHz
Input/Output Impedance	50 ohms (nominal)
Transmit Audio Response	6 dBm/octave pre-emphasis
Modulation	1M25F9W (1.25 MHz bandwidth) CDMA
CDMA Transmit Waveform Quality (Rho)	0.94

Receiver Function	Specification
Receive Sensitivity	-116 dBm -104 dBm (CDMA/PCS, 0.5% Static FER) 0.5% or less
Audio Distortion	Less than 5% at 1004 Hz, +/- 8 kHz peak frequency deviation (transmit and receive)

---

## Product Overview

Motorola V3m mobile telephones feature Code Division Multiple Access (CDMA) technology. The mobile telephone uses a simplified icon and Graphical user interface (GUI) for easier operation, allow Short Message Service (SMS) text messaging, and include clock, alarm, datebook, calculator, and caller profiling personal management tools. The V3m telephones include a built in camera. The phone provides 32 Embedded ring tones including VibraCall vibrating alert and 32 Downloadable/Customizable iMelody ring tones. The V3m telephones are dual band that allows roaming within the CDMA 800 MHz and PCS 1900 MHz bands.

The V3m CDMA phones consist of a main housing assembly and a flip assembly. The main circuit board, battery, headset jack, and accessory connector are located in the main housing assembly. The camera on the V3m phones is located in the hinged flip assembly.

The flip assembly contains the entire hinge mechanism. It is attached to the main housing by four screws. The main display is on the inside of the flip assembly and a one line LED display on the outside of the flip assembly. The main display on the V3m phones is a 176 x 220 pixel 65k TFT LCD. The external CLI display is a 96 x 80 pixel 65K CSTN LCD. The camera module is a 1.3 mega-pixel, VGA CMOS camera.

The main housing assembly includes a battery cover, chassis, main circuit board, keypad plastic front housing, and internal antenna.

The main circuit board contains the Receiver, Transmitter, Synthesizer and Control Logic Circuitry which together comprise the dual band tri-mode phone electronics.

The telephones are made of polycarbonate plastic. The display and speaker, as well as the 18-key keypad, transceiver printed-circuit board (PCB), microphone, charger and headphone connectors, and power button are contained within the flip form-factor housing. The 740 mAh Lithium Ion (Li Ion) battery provides up to 180 minutes of talk time in CDMA mode with up to 195 hours of standby time<sup>1</sup>.

## Features

V3m telephones use advanced, self-contained, sealed, custom integrated circuits to perform the complex functions required for CDMA communication. Aside from the space and weight advantage, microcircuits enhance basic reliability, simplify maintenance, and provide a wide variety of operational functions.

Features available in this family of telephones include:

- Built in VGA Camera (1.3 Mega-pixel)
- Video capture and playback
- 65K Thin Film Transistor (TFT) Active Color Display
- External color CLI Display
- Enhanced VST - Speaker independent calling
- Speaker Phone
- Stereo Headset support
- Class 2 Bluetooth®
- 23MB User Memory
- Micro-SD removable memory

---

1. All talk and standby times are approximate and depend on network configuration, signal strength, and features selected.

---

## Wireless Access Protocol (WAP) 1.1 Compliancy

In the WAP environment, access to the Internet is initiated in wireless markup language (WML), which is derived from hypertext markup language (HTML). The request is passed to a WAP gateway, which retrieves the information from the server in standard HTML (subsequently filtered to WML) or directly in WML, if available. The information is then passed to the mobile subscriber via the mobile network.

The microbrowser can be configured for baud, idle timeout, line type, phone number, and connection type.



*Bitmap image data will download as text. If the image is larger than the screen, only part of the image will display.*



*When the user receives a call while in browser mode, the browser will pause and allow the user to resume after completing the call.*

## Simplified Text Entry

There are three different ways to enter text using the phone keypad:

- iTAP™ predictive text entry. Press a key to generate a character and a dynamic dictionary uses this to build and display a set of word or name options. The iTAP™ feature may not be available on the phone in all languages.
- Tap. Press a key to generate a character.
- Numeric. The keypad produces numeric characters only. For some text areas this is the only method available; for example, phone numbers.

## Caller Line Identification

Upon receipt of a call, the calling party's phone number is compared to the phone book. If the number matches a phone book entry, that name will be displayed. If there is no phone book entry, the incoming phone number will be displayed. In the event that no caller identification information is available, the Incoming Call message is displayed.



*User must subscribe to a caller line identification service through their service provider.*

## Other Features

Detailed descriptions of these and other features can be found in the appropriate user's guide listed in the "Related Publications" section toward the end of this manual.

# General Operation

## Controls, Indicators, and Input / Output (I/O) Connections

The telephone's controls are located on the sides of the flip and on the keypad. Indicators, in the form of icons, are displayed on the LCD (see Figure 2). V3m phones have an audible alert transducer at the bottom and I/O connectors, consisting of a charger/accessory port, located on the side of the phone. See Figure 1.

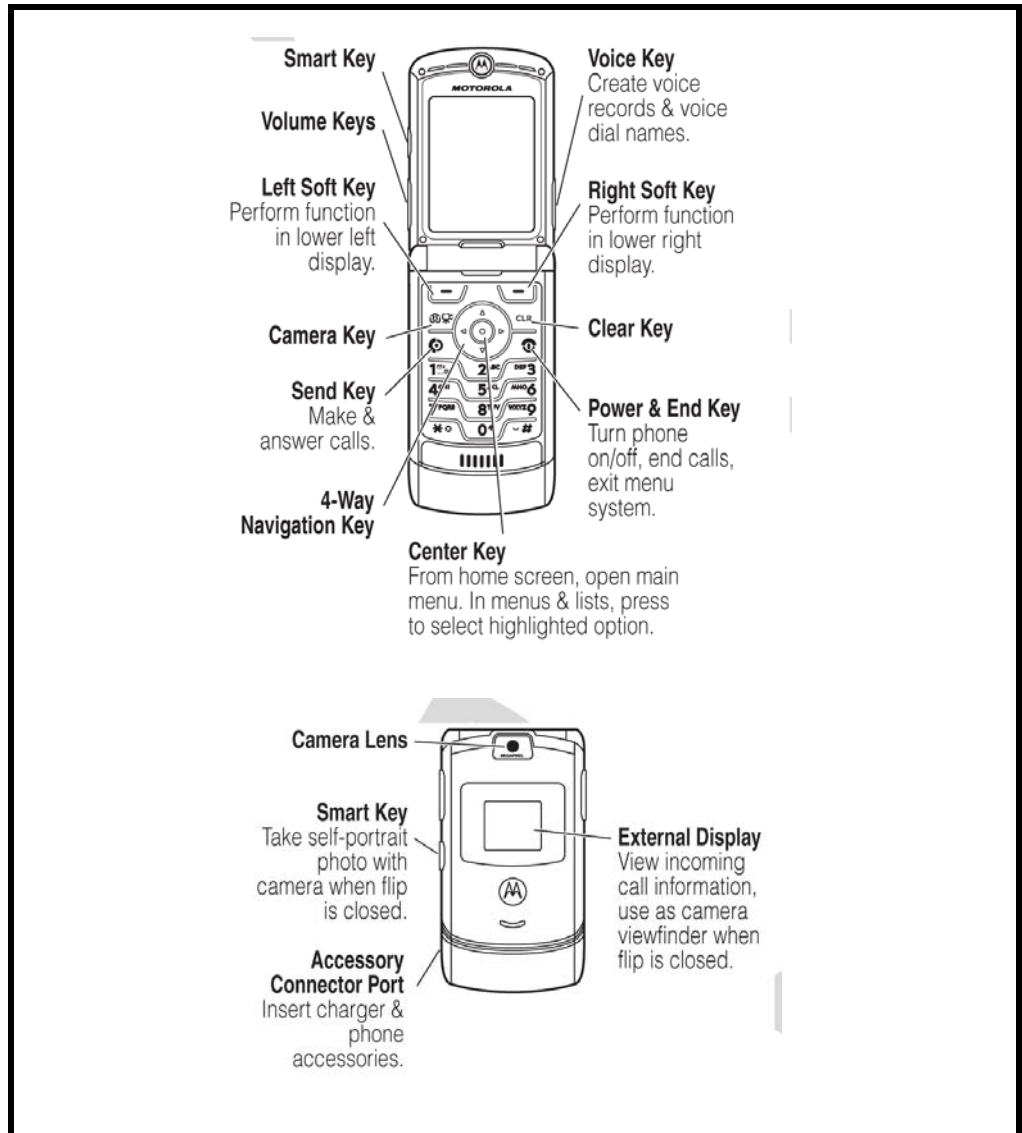

051355o/051356o

Figure 1. Controls, indicators, and I/O

“Soft keys” refer to non-labeled keys that correspond to text options displayed on the screen. The left and right soft keys perform the function shown in the corners

of the display. The right key will usually select an option whereas the left key will usually exit a function or return to a previous screen.

## Color Display

The V3m wireless phones feature a 65k color Thin Film Transistor (TFT) 176 x 220 pixel display.

Display animation makes the phone's menus move smoothly as the user scrolls up and down. Turn animation off to conserve the battery.

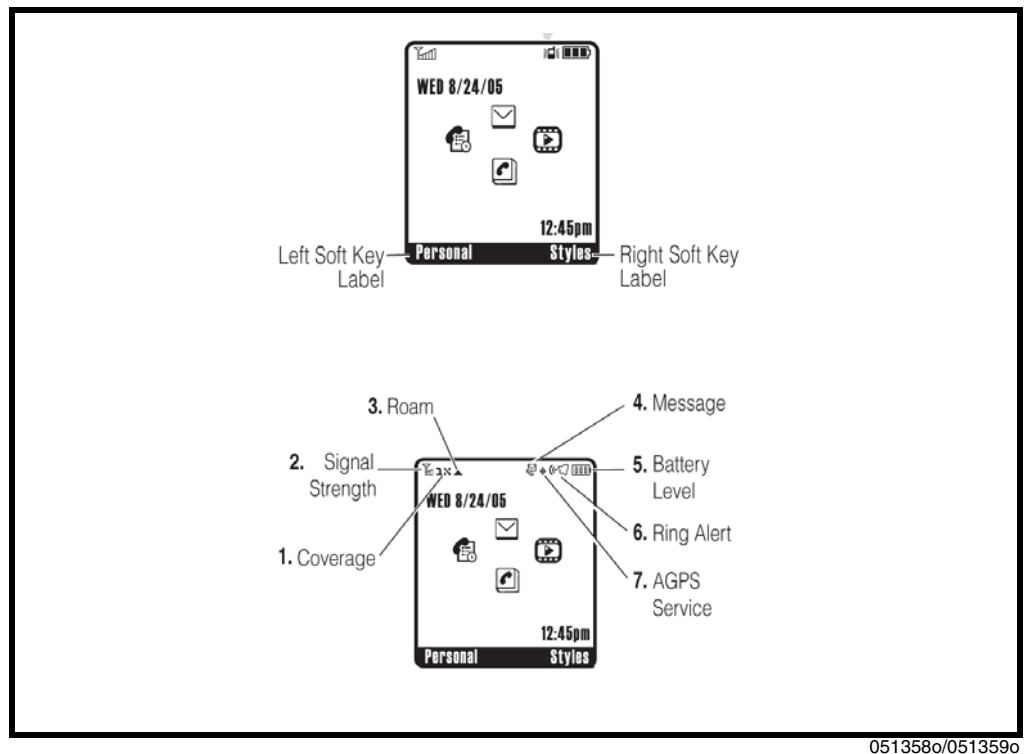

051358o/051359o

**Figure 2. Icon Indicators**



*Whether a phone displays all indicators depends on the programming and services to which the user subscribes.*

Figure 2 shows some common icons displayed on the LCD.

- **In Use Indicator.** Appears when a call is in progress.
- **Signal Strength Indicator.** Shows the strength of the phone's connection with the network. Calls cannot be sent or received when the "no signal" indicator is displayed.
- **Roam Indicator.** Appears when the phone uses another network system outside the user's home network. When leaving the home network area, the phone roams, or seeks another network.
- **Message Waiting Indicator.** Appears when the phone receives a text message. This is a network-dependent feature.
- **Battery Level Indicator.** Shows the amount of charge left in the battery. The more segments visible, the greater the charge. Recharge the battery as soon as

---

possible when the Low Battery warning message appears.

- **Voice Message Waiting Indicator.**<sup>2</sup> Appears when a voicemail message is received. This is a network-dependent feature.
- menu.
- **Alert Setting Indicator.** Shows the current selected alert. The default alert setting is a ringer.
- **GPS Indicator.** Shows when your phone can send location information  $\oplus$  or not  $\otimes$ .

---

2. Network, subscription service provider dependent feature. Not available in all areas.

## User Interface Menu Structure

Figure 3 shows the telephone menu structure.



051357o/051360

Figure 3. Menu Structure

## Alert Settings

V3m telephones include up to 32 preset alert tones and vibrations that can be applied to all alert events at the same time.



*Pressing either volume key will mute the alert.*

## Battery Function

### Battery Gauge

The telephone displays a battery level indicator icon in the idle screen to indicate the battery charge level. The gauge shows four levels: 100%, 66%, 33%, and Low Battery.

### Battery Removal

Removing the battery causes the device to immediately shut down and any pending work (for example, partially entered phone book entries or outgoing messages) is lost.



*To ensure proper memory retention, turn OFF the phone before removing the battery. Immediately replace the old battery with a fresh battery.*



*If the battery is removed while receiving a message, the message will be lost.*

## Operation

For detailed operating instructions, refer to the appropriate User's Guide listed in the Related Publications section toward the end of this manual.



## Tools and Test Equipment

The following table lists tools and test equipment recommended for disassembly and reassembly of V3m telephones. Use either the listed items or equivalents.

**Table 1. General Test Equipment and Tools**

Motorola Part Number <sup>1</sup>	Description	Application
RSX4043-A	Torque Driver	Used to remove and replace screws
—	Torque Driver Bit T-5, Apex 440-6IP Torx Plus or equivalent	Used with torque driver
	T-3 Bit	Used with torque driver
See Table 7	Rapid Charger	Used to charge battery and to power device
0180386A82	Antistatic Mat Kit (includes 66-80387A95 antistatic mat, 66-80334B36 ground cord, and 42-80385A59 wrist band)	Provides protection from damage to device caused by electrostatic discharge (ESD)
0-00-00-30005	Disassembly tool, plastic with flat and pointed ends (manual opening tool) from AMS	Used during assembly/disassembly of device
	Tweezers, plastic	Used during assembly/disassembly
—	Digital Multimeter, HP34401A <sup>2</sup>	Used to measure battery voltage

1. To order in North America, contact Motorola Aftermarket and Accessories Division (AAD) at (800) 814-0601 or FAX (800) 622-6210; Internationally, AAD can be reached by calling (847) 538-8023 or faxing (847) 576-3023.

2. Not available from Motorola. To order, contact Hewlett Packard at (800) 452-4844.

AMS Software & Elektronik GmbH  
 c/o Holger Grube  
 Lise-Meitner-Straße 9  
 D-24914 Flensburg Tel.: +49-461-90398-0  
 Fax: +49-461-90398-50

---

## Disassembly

The procedures in this section provide instructions for the disassembly of V3m telephones. Tools and equipment used for the phone are listed in Table 1, preceding.



*Many of the integrated devices used in this equipment are vulnerable to damage from electrostatic discharge (ESD). Ensure adequate static protection is in place when handling, shipping, and servicing the internal components of this equipment.*



*Avoid stressing the plastic in any way to avoid damage to either the plastic or internal components.*

## Removing and Replacing the Battery Cover and Battery



*All batteries can cause property damage and / or bodily injury, such as burns if a conductive material, such as jewelry, keys, or beaded chains touch exposed terminals. The conductive material may complete an electrical circuit (short circuit) and become quite hot. Exercise care in handling any charged battery, particularly when placing it inside a pocket, purse, or other container with metal objects.*

1. Ensure the phone is turned off.
2. Press in and hold the battery door latch as shown in Figure 1.

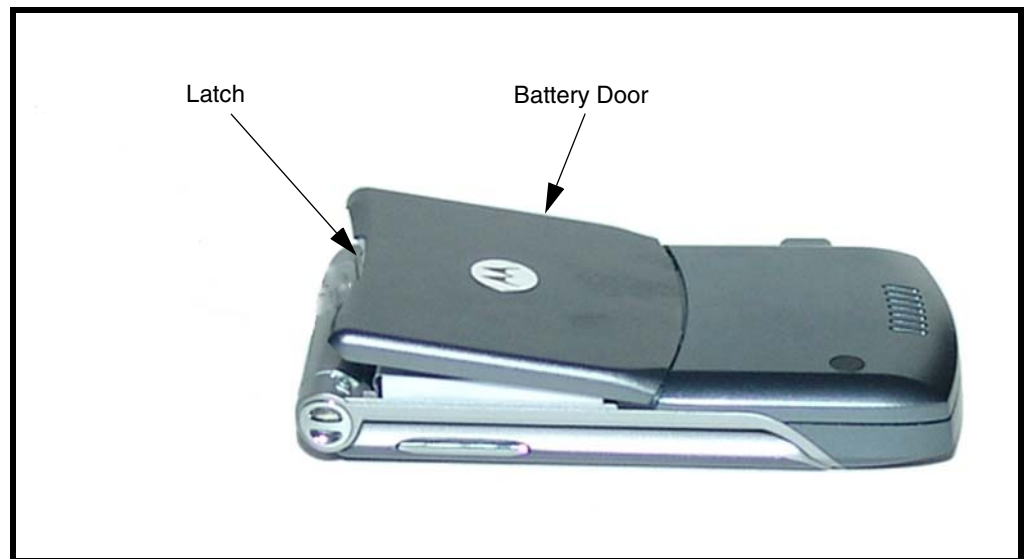

051341o

**Figure 1. Removing the Battery Cover**

3. Rotate the battery cover upward and lift it completely off the phone.

4. Lift the end of the battery first, then remove it from the phone. See Figure 2.

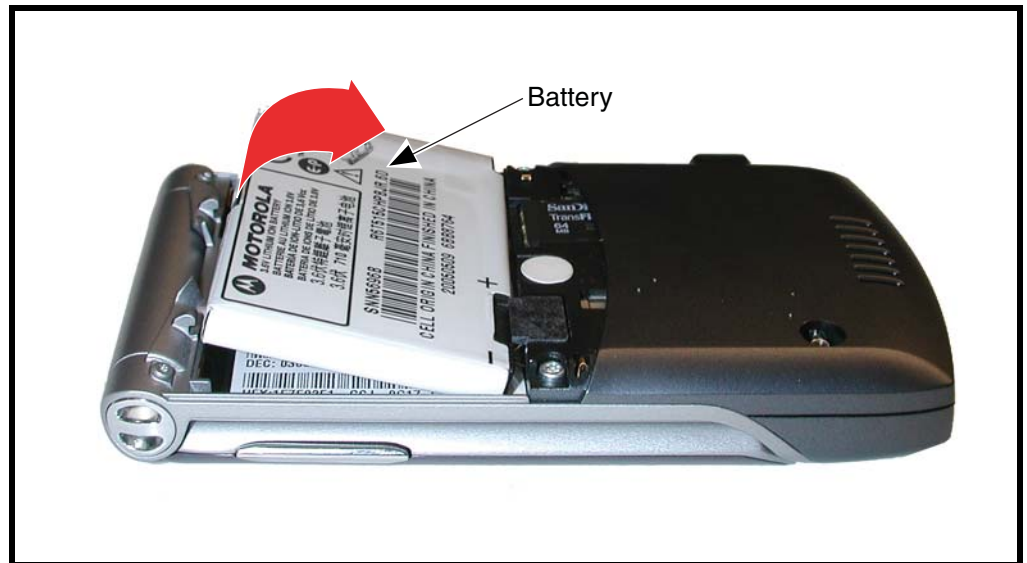

Figure 2. Removing the battery

0606580



*There is a danger of explosion if the Lithium Ion battery is replaced incorrectly. Replace only with the same type of battery or equivalent as recommended by the battery manufacturer. Dispose of used batteries according to the manufacturer's instructions.*

5. To replace, Align the battery with the battery compartment so the contacts on the battery match the battery contacts in the phone.
6. Insert the battery, contacts side first, into the battery compartment and push down followed by the opposite edge of the battery.
7. Insert the bottom edge of the of the battery cover into the rear housing, then push the top edge of the cover down and snap it into place.

## Removing and Replacing the Memory Card

1. Remove the battery cover, and battery as described in the procedures.
2. Slide the memory card out of the memory card slot as shown in Figure 3.

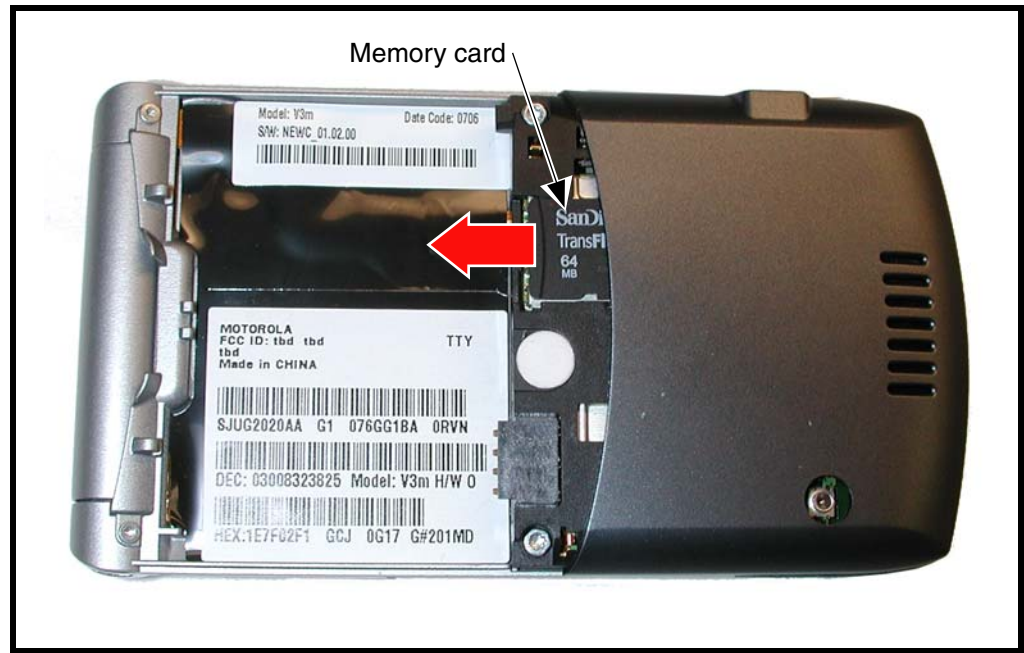

060658o

**Figure 3. Removing the Memory Card**

3. To replace, slide the memory card (contacts facing down) all the way into the memory card slot.
4. Replace the battery and the battery cover as described in the procedures.

## Removing and Replacing the Rear Housing



*This product contains static-sensitive devices. Use anti-static handling procedures to prevent electrostatic discharge (ESD) and component damage.*

1. Remove the battery cover, battery, and memory card as described in the procedures.



*In addition to 2 screws, the rear housing assembly is fastened with plastic latches. These are fragile and should be released with care.*

2. Using a Torx driver with a T-6 bit, remove the screws at each side of the phone. Retain the screws for reassembly. See Figure 4.

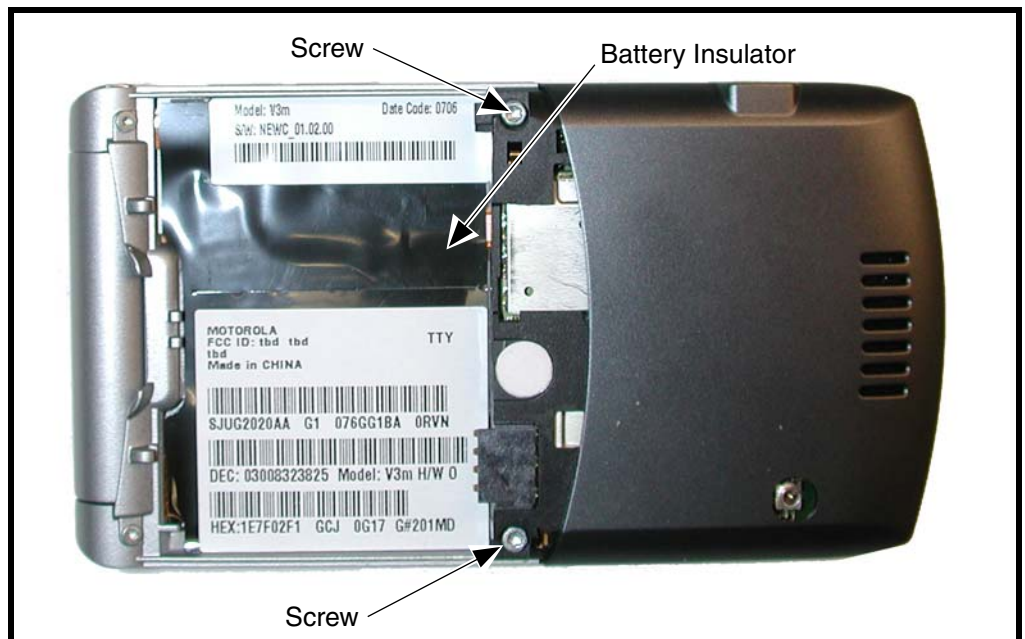

Figure 4. Removing the Rear Housing Screws

051343o

3. Use the plastic tweezers to remove the battery insulating material on the right side of the battery compartment. Do not reuse the battery insulating material for reassembly.

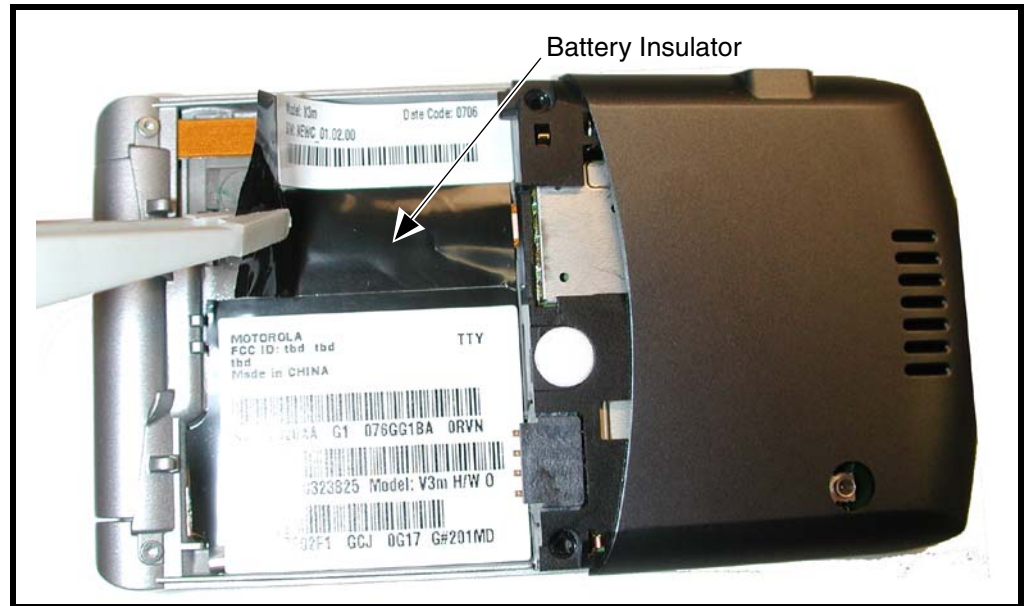
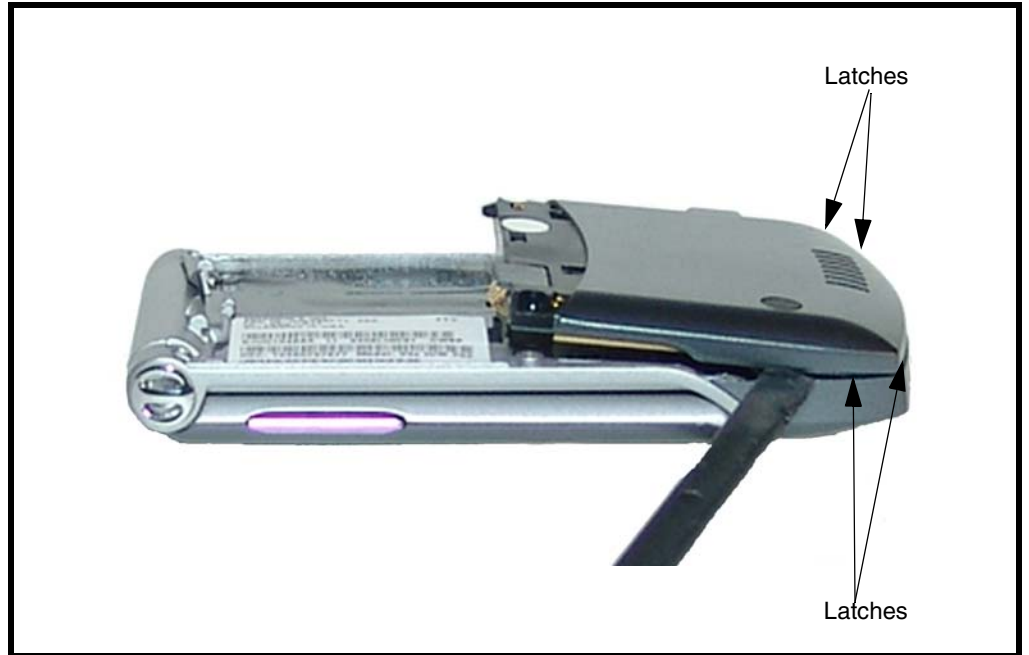

Figure 5. Removing the Rear Housing Screws

4. Release the 4 housing latches by inserting the pointed end of the plastic disassembly tool into the openings on the rear housing.



0513440

Figure 6. Removing the Rear Housing Latches

5. Carefully rotate the rear housing away from the front housing and flip assembly.

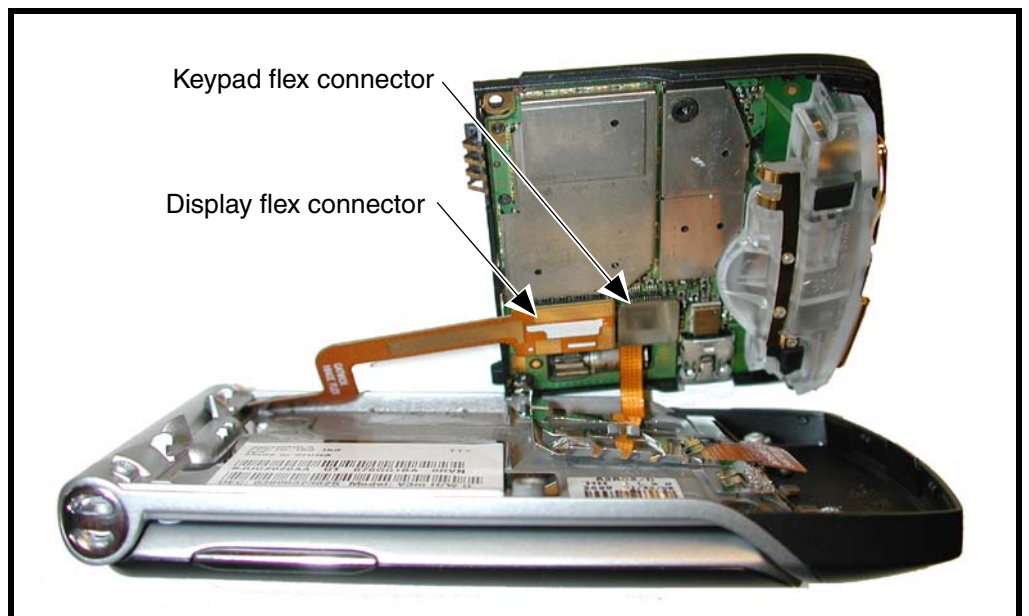

0606620

Figure 7. Removing the Rear Housing Assembly



*The flexible printed cable (FPC) (flex) is easily damaged. Exercise extreme care when handling.*

6. Use the disassembly tool to unseat the display flex connector and the keypad flex connector from their sockets.
7. Lift the rear housing assembly away from the phone.
8. To replace, carefully align the display flex connector to its socket on the rear housing assembly, then gently press down on the flex connector until it is properly seated in its socket.
9. Carefully align the keypad flex connector to its socket on the rear housing assembly, then gently press down on the flex connector until it is properly seated in its socket.
10. Rotate the rear housing assembly so it sits over the phone.
11. Align the housing latches with the corresponding openings on the front housing. Gently press the housings together until the catches snap into place.
12. Cover the display flex with new battery insulator material. Do not reuse the old battery insulating material.
13. Replace the 2 housing screws and tighten to a final torque setting of 24 Ncm (2.2 inch pounds). Do not over tighten.
14. Replace the antenna, battery, and battery cover as described in the procedures.



---

## Removing and Replacing the Antenna

1. Remove the battery cover, battery, and rear housing assembly as described in the procedures.
2. Use the metal tweezers to grasp the rubber antenna grommets and carefully remove them from the antenna assembly. See Figure 8. Set the rubber grommets aside for reuse.

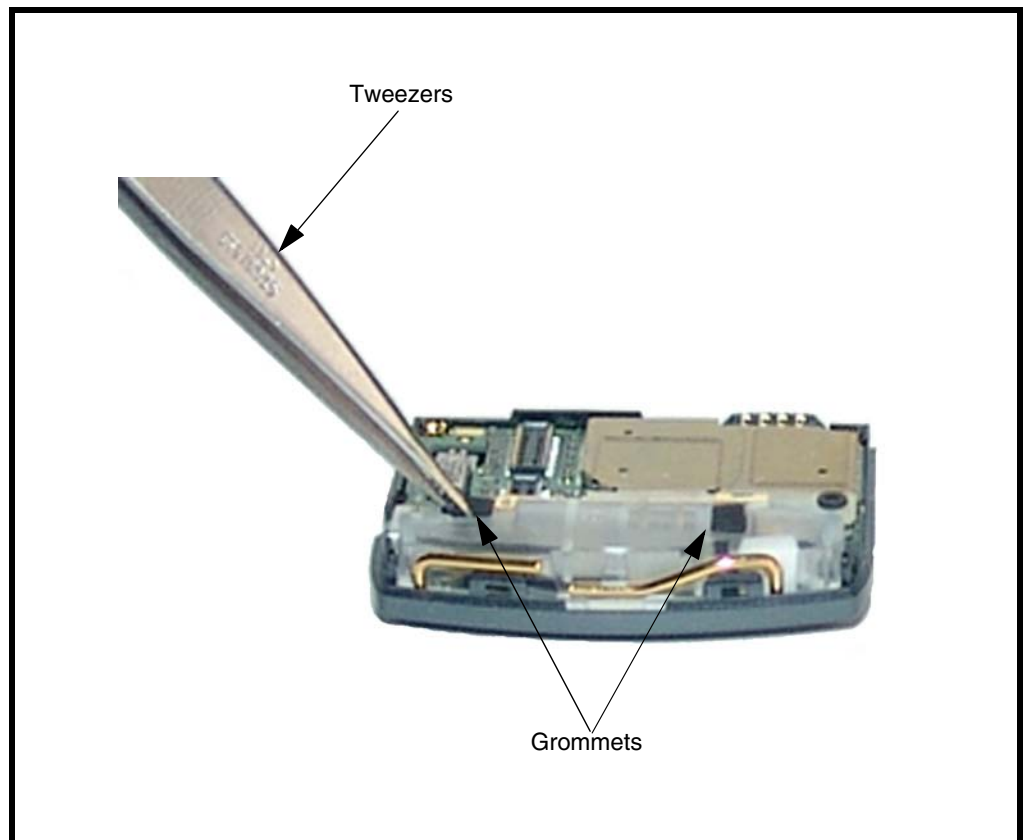
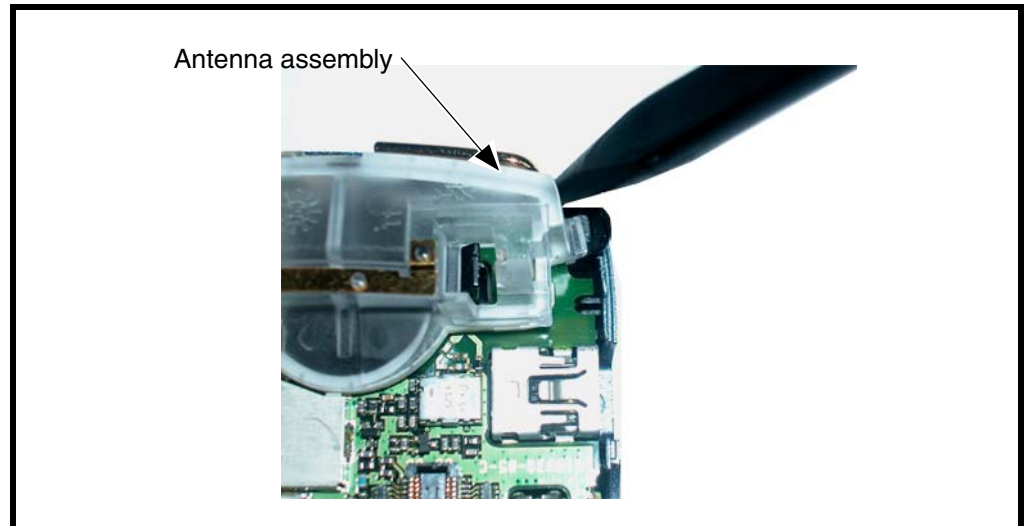

Figure 8. Removing the Antenna Grommets

0513460

3. Use the disassembly tool to release the antenna assembly starting from the right side as shown in Figure 9.



0606630

**Figure 9. Removing the Antenna Assembly**

4. Carefully lift the antenna assembly away from the phone.
5. To replace, align the antenna assembly to the phone.
6. Carefully press the antenna assembly into position starting from the left side until the antenna assembly latches snap into position.
7. Reinstall the rubber antenna assembly grommets into their slots. Each antenna grommet is uniquely shaped to fit into its respective position.
8. Replace the rear housing assembly, battery and battery cover as described in the procedures.

## Removing and Replacing the Transceiver Board Assembly



*This product contains static-sensitive devices. Use anti-static handling procedures to prevent electrostatic discharge (ESD) and component damage.*

1. Remove the battery cover, battery, antenna, rear housing and battery tray as described in the procedures.
2. Lift the transceiver board assembly out of the front housing with the disassembly tool. See Figure 10.

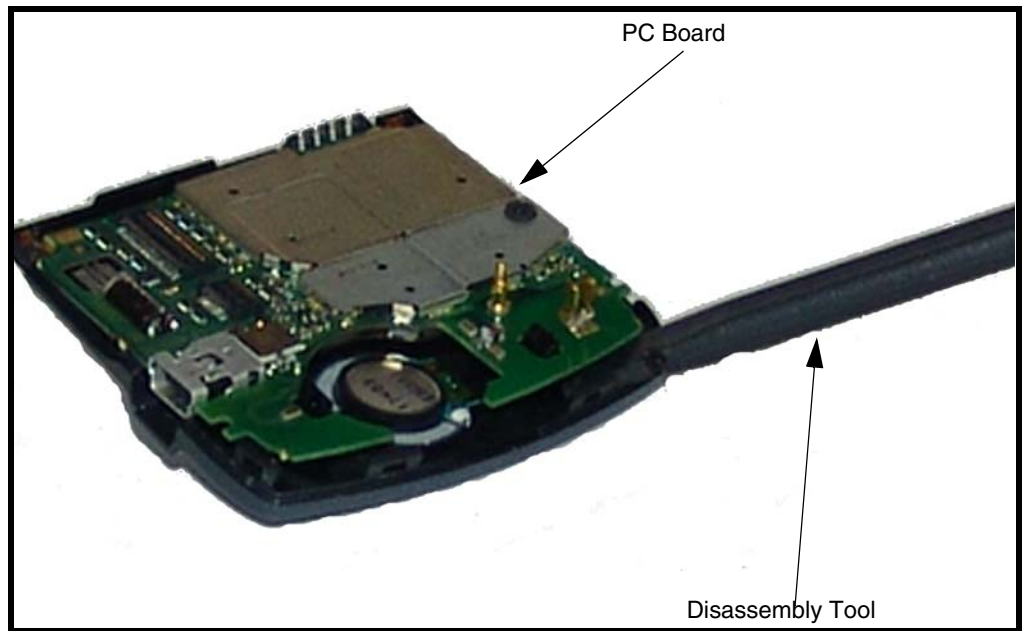
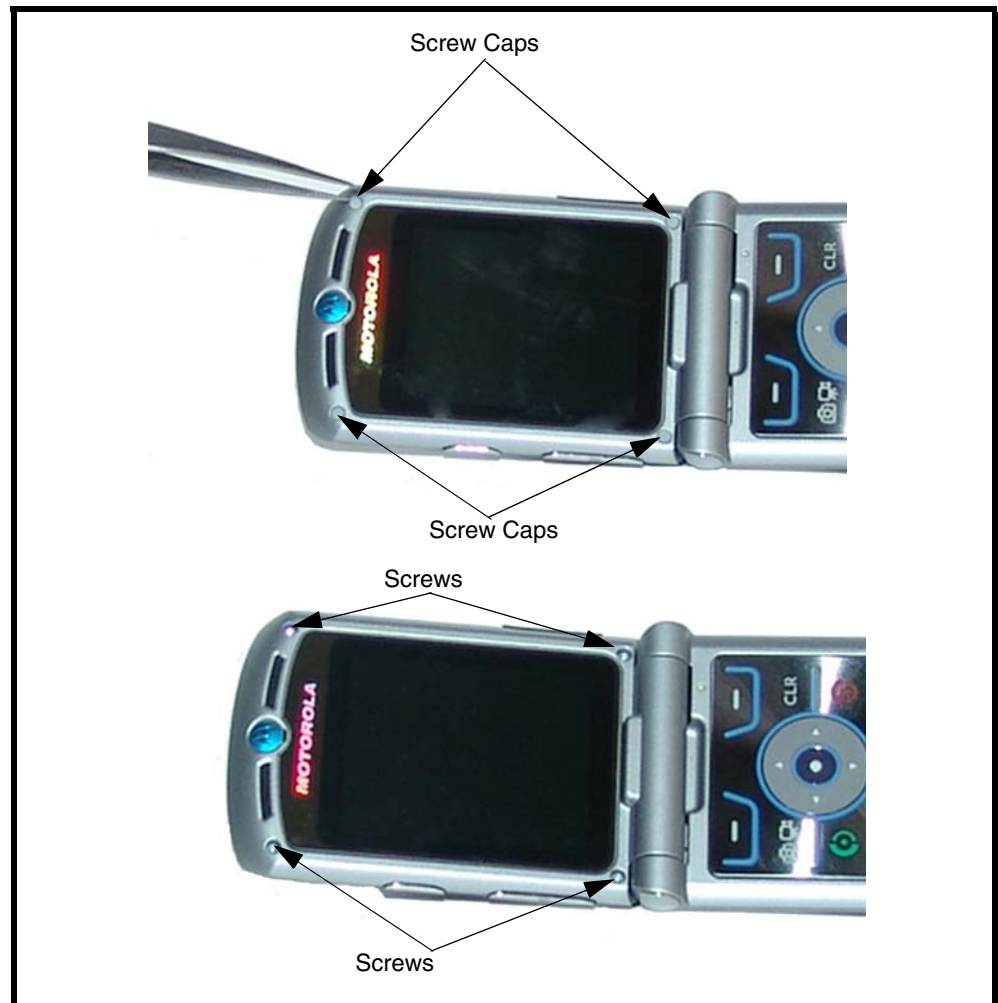

**Figure 10. Removing the Transceiver PC board Assembly**

3. To replace, insert the transceiver board assembly into the rear housing.
4. Carefully and gently press the transceiver board into position and until it snaps into place.
5. Replace the antenna assembly, rear housing, battery, and battery cover as described in the procedures.

## Removing and Replacing the Flip Assembly Cover and CLI Lens

1. Remove the battery cover, battery, antenna, rear housing, and transceiver board assembly as described in the procedures.
2. Remove the 4 flip assembly screw caps.
3. Use the T-5 driver to remove the 4 screws from the flip assembly (see Figure 11). Retain the screws for re-assembly.



051349/051350o

**Figure 11. Removing the Flip Assembly Screws**

4. Before removing the flip cover, note the locations of the smart buttons on the sides of the flip assembly.

5. Use the disassembly tool to gently pry off the flip cover (see Figure 12).

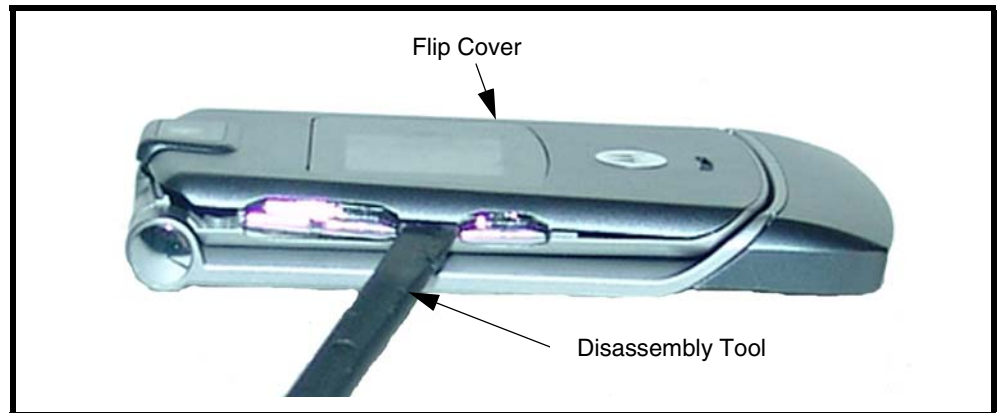

051351o

**Figure 12. Separating the Flip Assembly Cover**

6. Remove the smart buttons on the side of the flip assembly. Set them aside for reassembly.
7. Lift the flip cover away from the flip assembly. Be careful not to damage the display flex cable.
8. Slide the flat end of the plastic disassembly tool, between the lens and the metal frame.

9. Slowly rotate the plastic disassembly tool by 90° (see Figure 13).

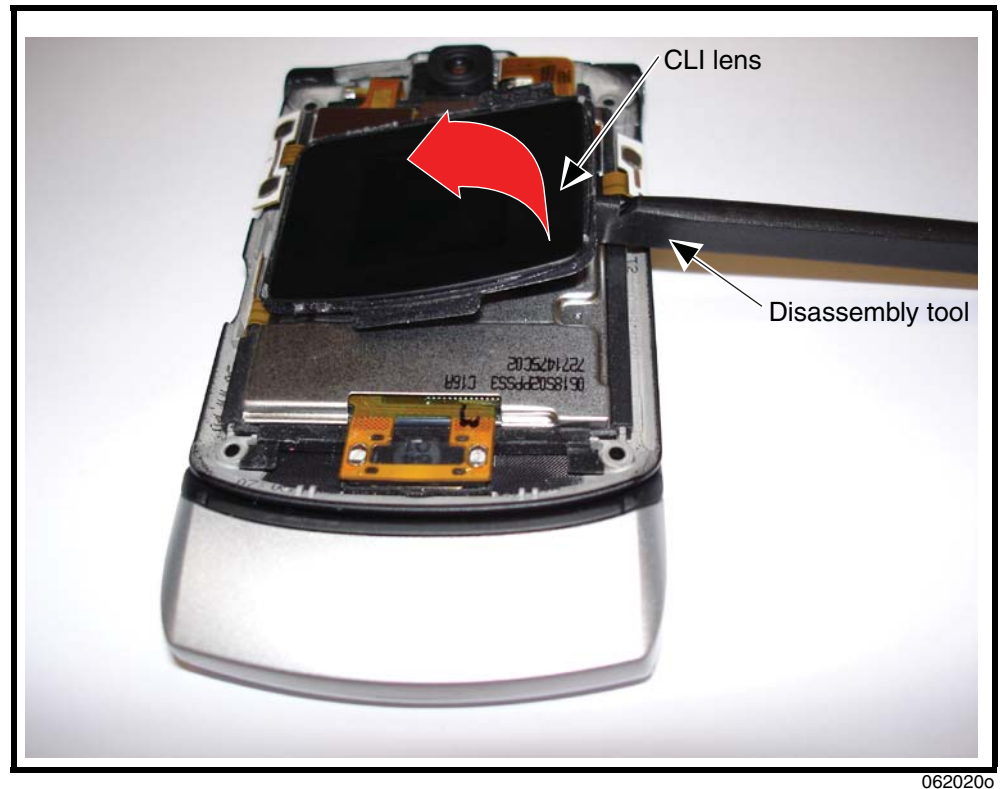

**Figure 13. CLI Lens Removal**

10. Carefully lift up the CLI Lens from the display module assembly.
11. Carefully use the plastic tool remove any remaining glue.



Do not use any kind of liquid or spray to remove the remaining glue.

12. To replace, align CLI lens to the Flip Outer Assembly. Move the CLI lens to the opening. Ensure that the liner is overlapping the inside surface. The CLI lens fits in one direction only (see Figure 14).



0620260

**Figure 14. CLI Lens Replacement**

13. Expose the adhesive surface of the new CLI lens and attach the replacement CLI lens to the flip outer assembly.

- 
- Align CLI lens to the flip out assembly and lightly press the low tech film around the CLI. opening (see Figure 15).



062027o

**Figure 15. Flip CLI Lens Placement**



15. Align the top, left and right sides of the flip cover and press into position (see Figure 16).



0620280

Figure 16. Flip Cover Replacement, Top, Left and Right Sides

16. Apply pressure at the corners of the CLI Lens for 3 seconds to insure good adhesion (see Figure 17).



0620320

Figure 17. Flip CLI Lens Replacement

- 
17. Insert and tighten the 4 screws to 1.5 in lbs to secure the flip cover to the flip assembly. Avoid damage to the flex cable (see Figure 18).



0620400

Figure 18. Flip Screws Replacement

- 
18. Insert the 4 rubber screw caps over the flip assembly screws (see Figure 19).



0620410

**Figure 19. Flip Screw Cap Replacement**

19. Replace the transceiver board assembly, rear housing, antenna assembly, battery, and battery cover as described in the procedures.

## Removing and Replacing the Camera Assembly

1. Remove the battery cover, battery, antenna, rear housing, and transceiver board assembly, flip assembly cover, and CLI lens cover as described in the procedures.



*The flexible printed cable (FPC) (flex) is easily damaged. Exercise extreme care when handling.*

2. Unlock the ZIF connector and remove the camera assembly flex connector.
3. Carefully lift the camera assembly and flex out of the flip assembly (see Figure 20).

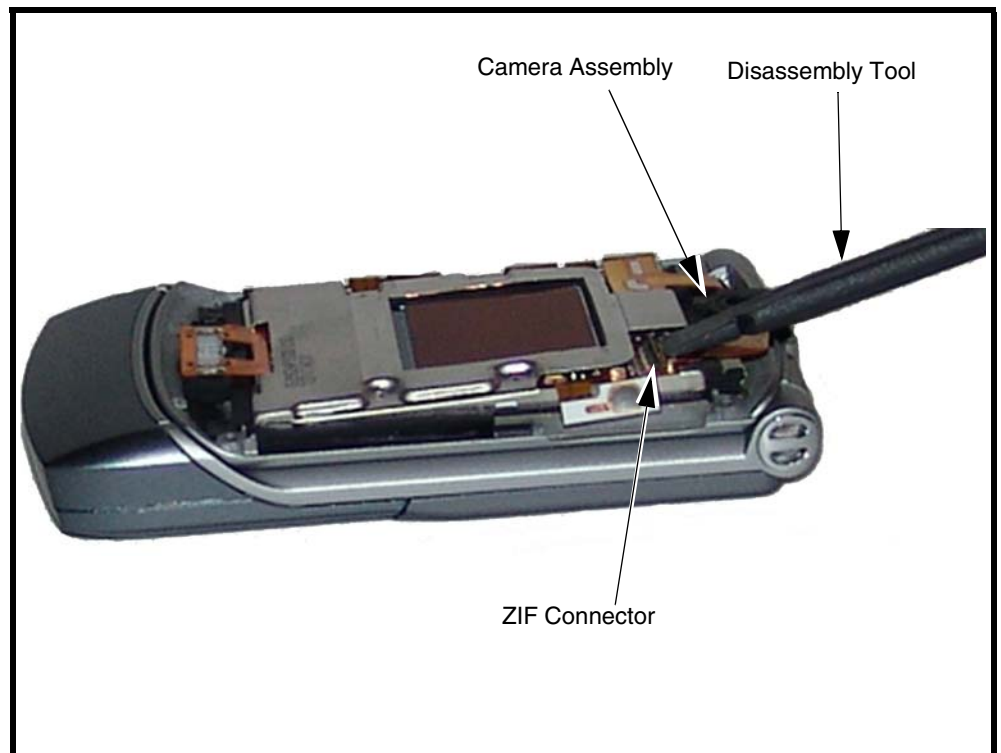

**Figure 20. Camera Assembly Removal**

4. To replace, carefully press the camera assembly into its slot in the flip assembly.
5. Insert the end of the camera assembly flex cable into its slot in the ZIF connector on the flip display assembly. Avoid damage to the flex cable.
6. Replace the flip assembly cover, transceiver board, rear housing, antenna, battery, and battery cover as described in the procedures.

---

## Removing and Replacing the Display Module Assembly

1. Remove the battery cover, battery, rear housing, antenna, transceiver board assembly, flip assembly cover, and camera assembly, as described in the procedures.



*The flexible printed cable (FPC) (flex) is easily damaged. Exercise extreme care when handling.*

2. Use the disassembly tool to unseat the display module assembly flex connector from its socket (see Figure 21).

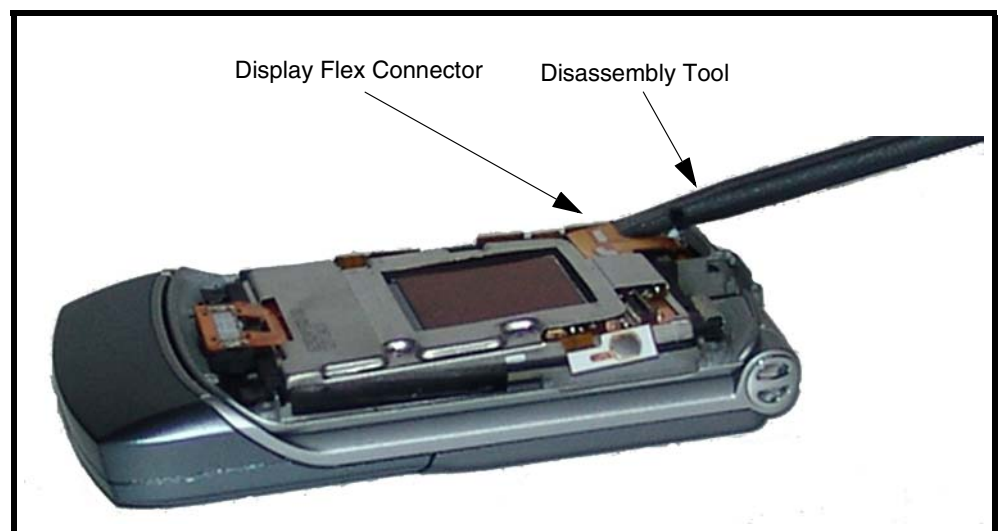

0513530

**Figure 21. Display Module Assembly Flex Connector**

3. Carefully and gently lift one corner of the display module assembly out of the flip assembly.
4. Avoid damage to the electrical components on the flex while carefully removing the display module assembly from the flip assembly.

- Carefully lift the display assembly away from the flip assembly (see Figure 22).

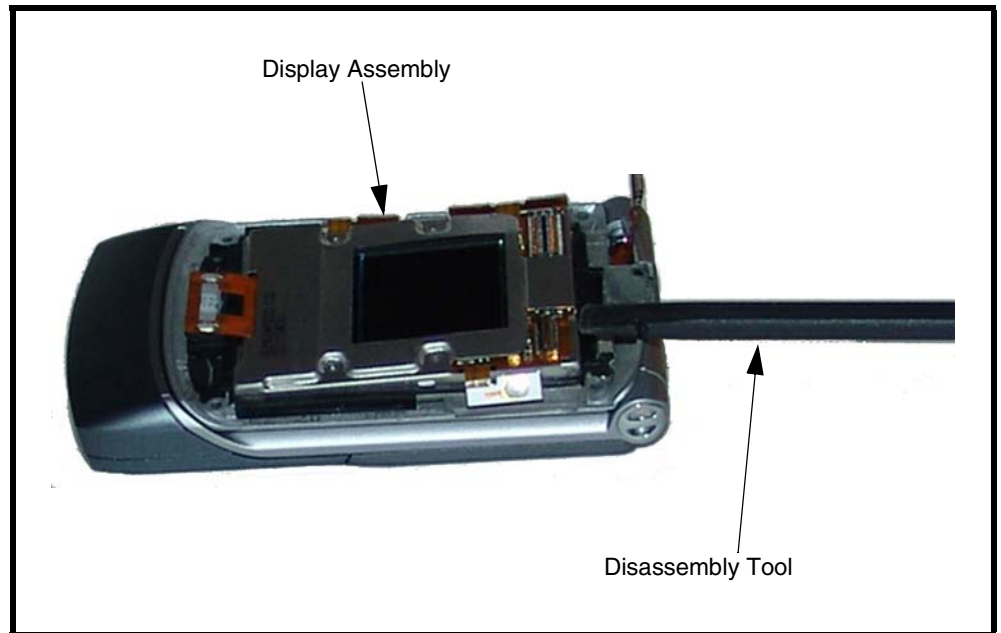
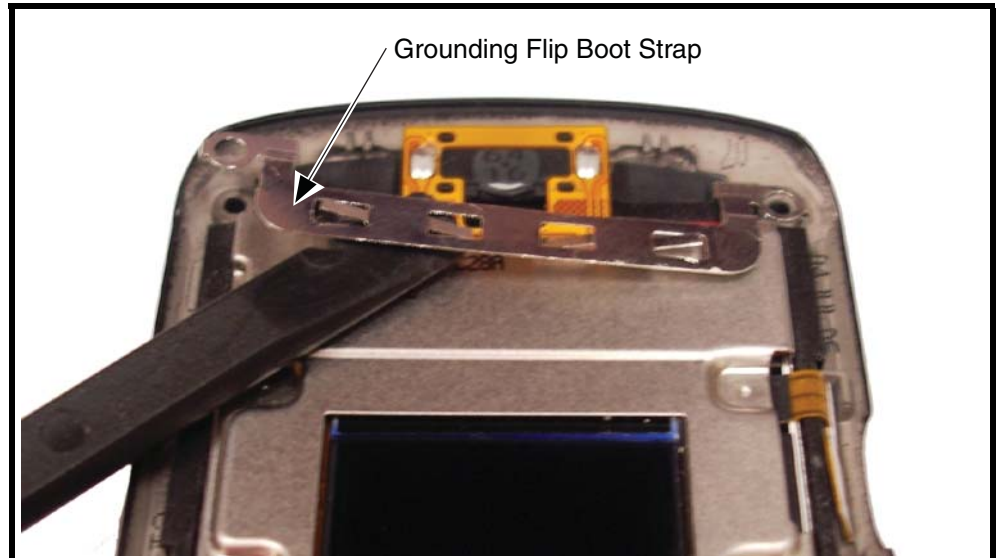

**Figure 22. Removing the Display Module Assembly**

- To replace, align the display module assembly to the flip assembly.
- Carefully lower the display module into the flip assembly. Ensure that all of the display none of the display assembly components are damaged.
- align the flip display flex to the flex connector on the flip display assembly and gently press down on the flex connector until properly seated.
- Replace the camera assembly, flip assembly cover, transceiver board, rear housing, antenna, battery, and battery connector as described in the procedures.

## Removing and Replacing the Hinge Assembly

1. Carefully lift up the grounding flip boot strap (see Figure 23).



062042o

**Figure 23. Lifting the Grounding Flip Boot Strap**



*The flexible printed cable (FPC) (flex) is easily damaged. Exercise extreme care when handling.*

2. Use the disassembly tool to unseat the display module assembly flex connector from its socket (see Figure 24).

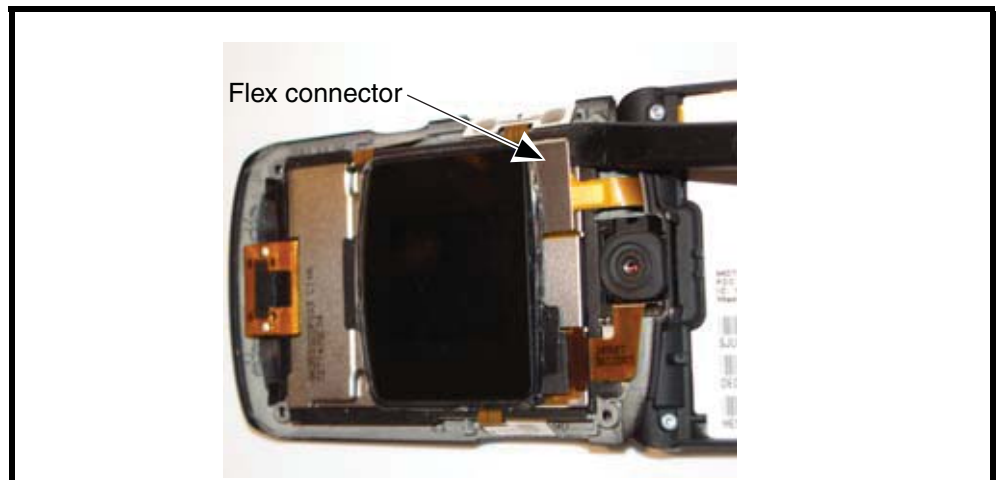

062000o

**Figure 24. Display Module Assembly Flex Connector**



- Carefully lift the camera assembly and flex out of the flip assembly (see Figure 25).

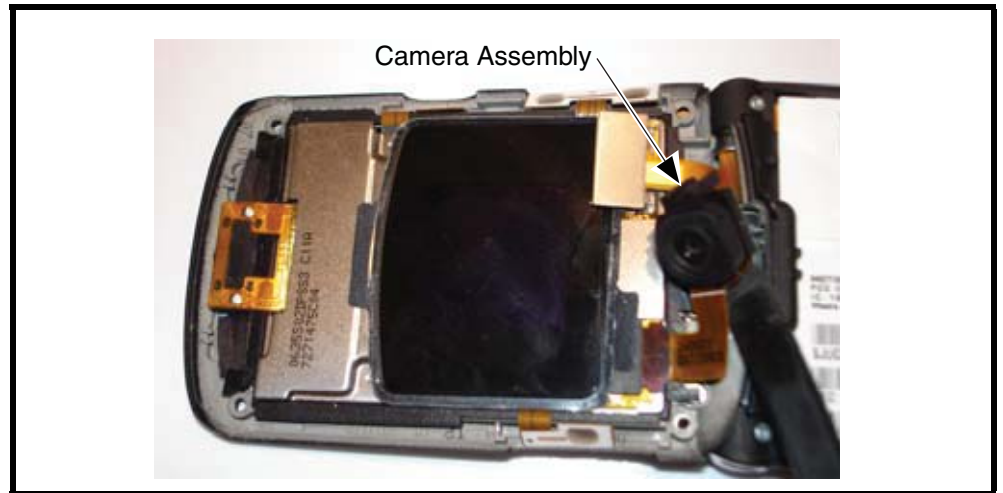

**Figure 25. Removing the Camera Assembly**

0620010

- Carefully and gently lift one corner of the display module assembly out of the flip assembly (see Figure 26).

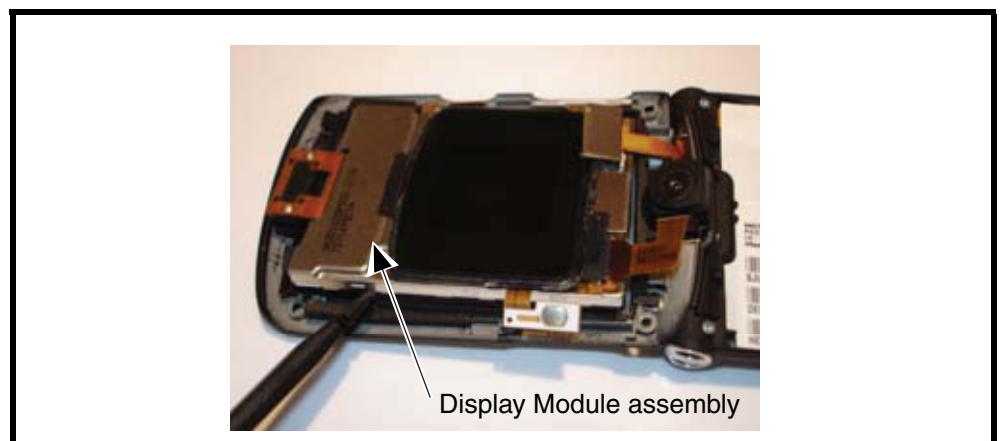

**Figure 26. Removing the Display Module Assembly**

0620020

- Avoid damage to the electrical components on the flex while carefully removing the display module assembly from the flip assembly.

6. Carefully lift the display gasket from the assembly (see Figure 27).



062043o

**Figure 27. Removing the Display Gasket**

7. Carefully lift the contact grounding hinge from the assembly (see Figure 28).



062044o

**Figure 28. Removing the Contact Grounding Hinge**

**Removing the 2 flip assembly screw caps.**

8. Use a T-3 driver to remove the 2 screws from the flip assembly (see Figure 29). Retain the screws for reassembly. Ensure the screws have thread lock.

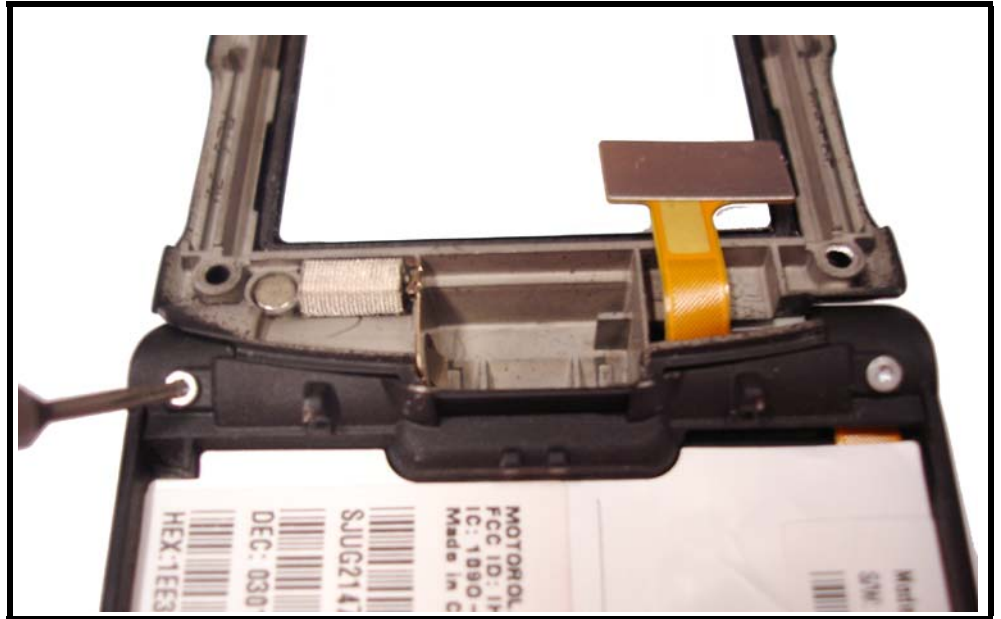

0620450

**Figure 29. Removing the Screw Caps**

9. Remove the 2 end caps from the assembly flip. Retain the end caps and grounding clip for reassembly (see Figure 30).



0620060

**Figure 30. Screw Caps Removed**

10. Use a small flat tip screwdriver to assist in disassembling the flip from the base housing.

11. Use a small flat tip screwdriver to press in the hinge cam while pushing the hinge cam towards top (see Figure 31).

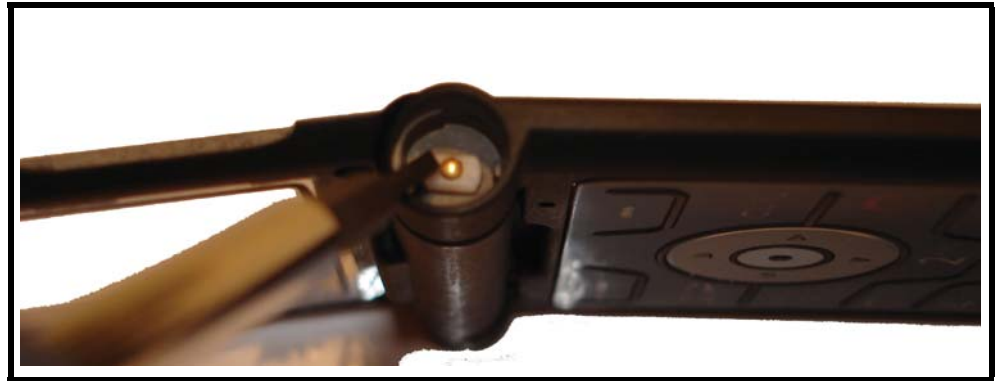

062007o

**Figure 31. Hinge Cam Location**

12. Rotate flip assembly away to disengage the hinge cam (see Figure 32).

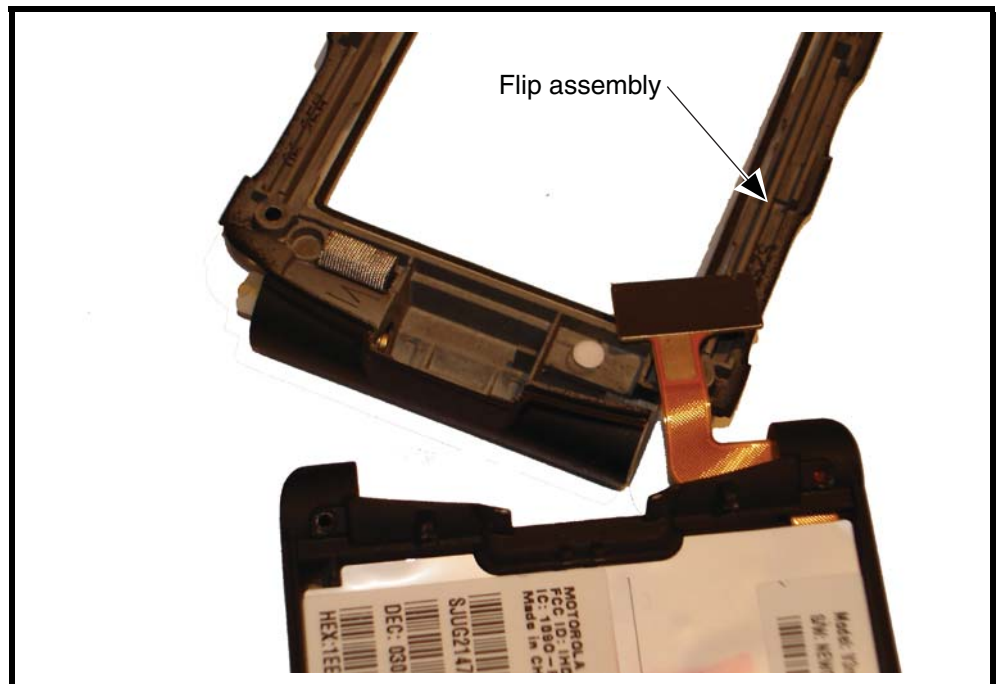

062008o

**Figure 32. Flip Assembly Removal**



*Ensure that display gasket and contact grounding hinge have been removed before continuing. Failure to remove these parts may cause damage to the Hinge Cam and Hinge Grounding Clip.*

**Removal of the Main Flex.**

13. Use the plastic tweezers to remove the battery insulating material on the right side of the battery compartment. Do not reuse the battery insulating material for reassembly (see Figure 33).

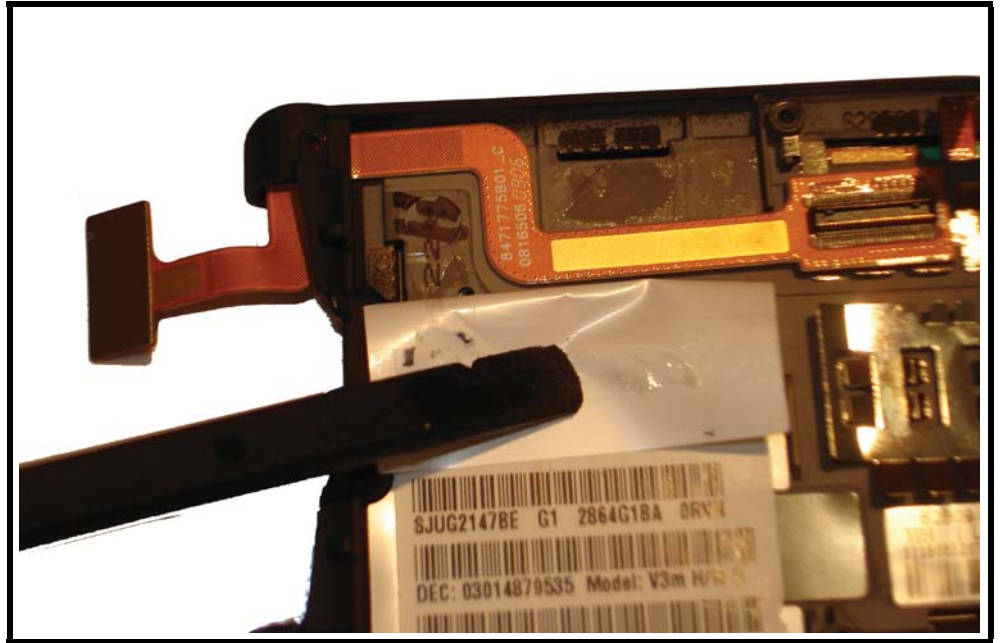

062009c

**Figure 33. Flex Removal Part 1**

14. Slide main flex though the opening by the hinge area (see Figure 34).

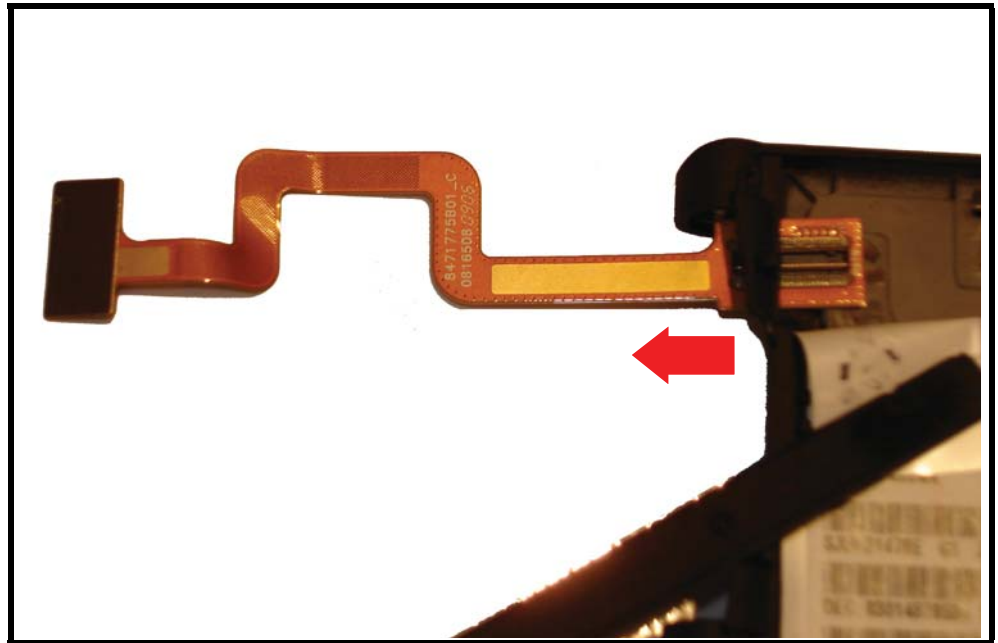

0620100

**Figure 34. Flex Removal Part 2**

#### **Replacing the Flip Hinge Assembly**

1. Carefully and gently slide the Main Flex though the opening by the hinge area (see Figure 35).



*The flexible printed cable (FPC) (flex) is easily damaged. Exercise extreme care when handling.*



0620120

Figure 35. Flex Reinstall Part 1

2. Align main flex to the groove location for the main flex (see Figure 36).



0620130

Figure 36. Flex Install Part 2

3. Insert flip sleeve so that it is flush with flip inner surface (see Figures 37 and 38).



062014o

Figure 37. Flip Sleeve Install Part 1



062014o

Figure 38. Flip Sleeve Install Part 2



4. Align flip housing to the front housing as shown (see Figure 39).



**Figure 39. Flip Hinge Alignment**

062014o

Note: Ensure that the housing and flip are not binding the main flex.



*The flexible printed cable (FPC) (flex) is easily damaged. Exercise extreme care when handling.*

5. Use a small flat tip screwdriver to press in the hinge cam while pushing the hinge cam towards the cam opening (see Figure 40). Ensure that all of the parts are aligned in the hinge area.



062017-19o

**Figure 40. Flip Hinge Reassembly**

6. Install the 2 end caps for the assembly flip. Ensure that the end caps and grounding clip are assembled (see Figure 41).



062006o

**Figure 41. End Cap Reinstall**

7. Use the T-3 driver to install and tighten the 2 screws to a final torque setting of 9.6 Ncm (.85 inch pounds). Do not over tighten (see Figure 42).

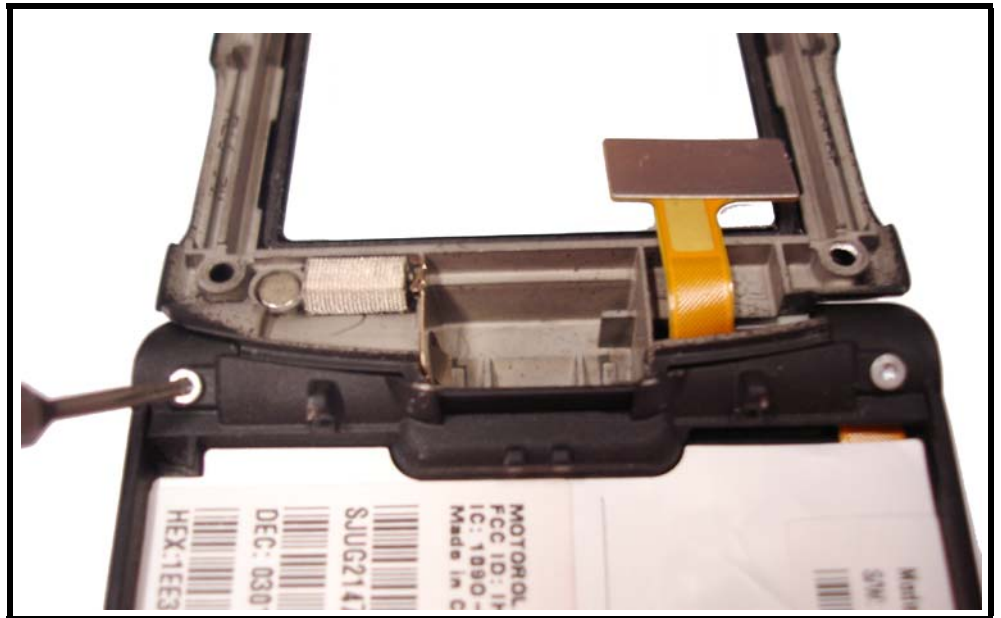

062005o

**Figure 42. Reinstalling the Screw Caps**

8. Carefully install the contact, grounding hinge to the assembly (see Figures 43 and 44).



0620200

Figure 43. Reinstalling the Contact Grounding Hinge Part 1



0620210

Figure 44. Reinstalling the Contact Grounding Hinge Part 2

9. Carefully place display gasket into assembly (see Figure 45).



**Figure 45. Reinstalling the Display Gasket**

0620220



*Ensure the display gasket is properly seated in the flip inner before installing the display module.*

10. Align the display module assembly to the flip assembly.
11. Carefully lower the display module into the flip assembly. Ensure that none of the display assembly components are damaged.

12. Carefully press the camera assembly into its slot in the flip (see Figure 46).

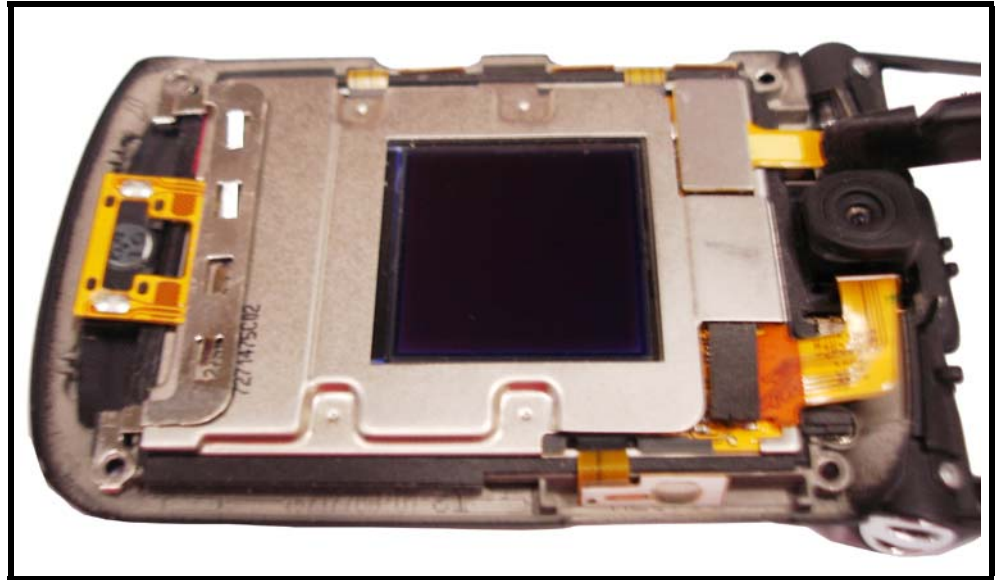

062046o

**Figure 46. Reinstalling the Display Assembly**

13. Insert the end of the camera assembly flex cable into its slot in the ZIF connector on the flip display assembly. Avoid damage to the flex cable.
14. Carefully insert switches into button cavities (see Figure 47a and 47b).

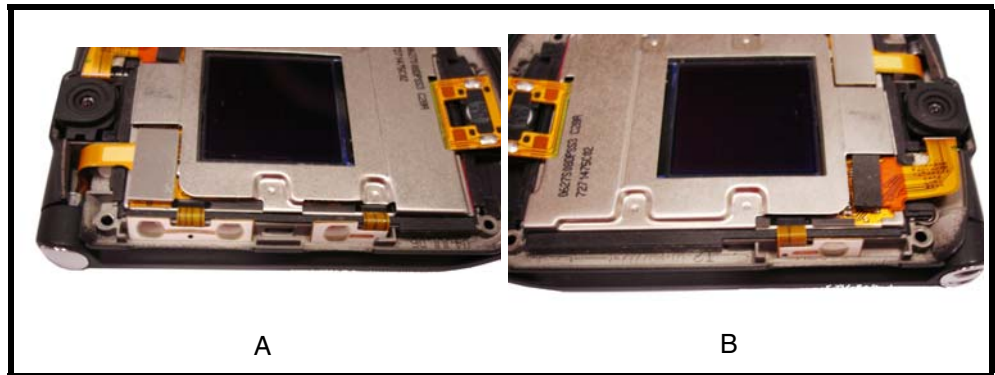

062047o, 062048o

**Figure 47. Replacing Switches in Button Cavities.**

15. Clip in the contact, grounding flip boot strap (see Figure 48).

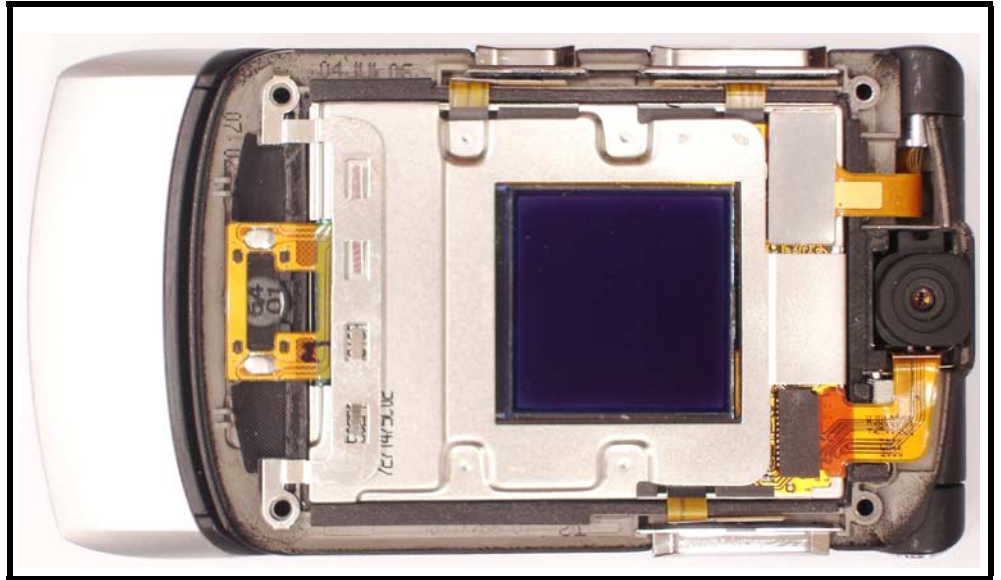

**Figure 48. Replacing the Contact Grounding Flip Boot Strap.**

16. Insert Button, Volume Control and Button VR (see Figure 48).
17. Replace the flip assembly cover, transceiver board, rear housing, antenna, battery, and battery cover as described in the procedures.

# Phone Identification

## Personality Transfer

A personality transfer is required when a phone is express exchanged or when the main board is replaced. Personality transfers reproduce the customer's original personalized details such as menu and stored memory such as phone books, or even just program a unit with basic user information such as language selection.

## Identification

Each Motorola CDMA phone is labeled with a variety of identifying numbers. Figure 49 describes the current identifying labels.

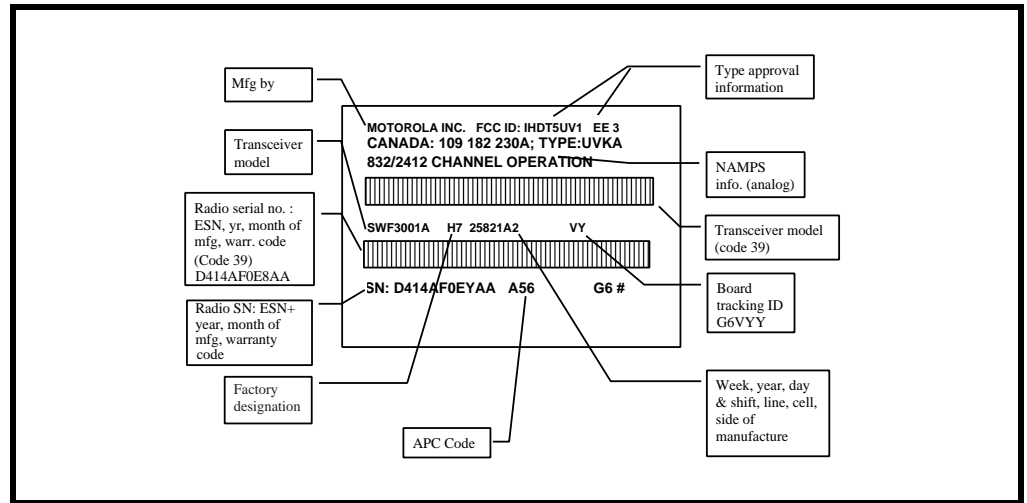

020463o

Figure 49. CDMA Telephone Identification Label



## Troubleshooting Chart

**Table 2. Level 1 and 2 Troubleshooting Chart**

SYMPTOM	PROBABLE CAUSE	VERIFICATION AND REMEDY
1. Telephone will not turn on or stay on.	a) Battery either discharged or defective.	Measure battery voltage across a 50 ohm (>1 Watt) load. If the battery voltage is <3.25 Vdc, recharge the battery using the appropriate battery charger. If the battery will not recharge, replace the battery. If battery is not at fault, proceed to b.
	b) Battery connectors open or misaligned.	Visually inspect the battery connectors on both the battery and the telephone. Realign and, if necessary, either replace the battery or refer to a Level 3 Service Center for the battery connector replacement. If battery connectors are not at fault, proceed to c.
	c) Transceiver board assembly defective.	Remove the transceiver board assembly. Substitute a known good assembly and temporarily reassemble the unit. Press and hold the PWR button; if unit turns on and stays on, disconnect the dc power source and reassemble the telephone with the new transceiver board assembly. Verify that the fault has been cleared.
2. Telephone exhibits poor reception or erratic operation such as calls frequently dropping or weak or distorted audio.	a) Antenna assembly defective.	Check to make sure that the antenna pin is properly connected to the transceiver board assembly. If connected properly, substitute a known good antenna. If the fault is still present, proceed to b.
	b) Transceiver board assembly defective.	Replace the transceiver board assembly (refer to 1c). Verify that the fault has been cleared and reassemble the unit with the new transceiver board assembly.
3. Display is erratic, or provides partial or no display.	a) Transceiver board connections faulty.	Remove rear chassis assembly from unit, check general condition of flexible printed cable (flex). If the flex is good, check that the flex connector is fully pressed down. If not, check connector to transceiver board connections. If faulty connector, replace the transceiver board assembly. If connector is not at fault, proceed to b.
	b) Flip assembly defective.	Temporarily replace the flip assembly with a known good assembly. If fault has been cleared, reassemble with the new flip assembly. If fault not cleared, proceed to c.
	c) Transceiver board assembly defective.	Replace the transceiver board assembly (refer to 1c). Verify that the fault has been cleared and reassemble the unit with the new transceiver board assembly.
4. Incoming call alert transducer audio distorted or volume is too low.	Faulty transceiver board assembly.	Replace the transceiver board assembly (refer to 1c). Verify that the fault has been cleared and reassemble the unit with the new transceiver board assembly.
5. Telephone transmit audio is weak. (usually indicated by called parties complaining of difficulty in hearing voice).	a) Microphone obstructed by user while holding the phone.	If the transmit audio quality is still weak and the microphone is not obstructed proceed to b.

**Table 2. Level 1 and 2 Troubleshooting Chart (Continued)**

SYMPTOM	PROBABLE CAUSE	VERIFICATION AND REMEDY
	b) Microphone is defective.	Replace the microphone as described in the procedures. If the fault is not cleared, proceed to c.
	c) Transceiver board is defective	Replace the transceiver board as described in the procedures.
6. Receive audio from earpiece speaker is weak or distorted.	a) Connections to or from transceiver board assembly defective.	Gain access to the transceiver board assembly as described in the procedures. Check flex and the flex connector from the flip assembly to the transceiver board assembly. If flex is at fault, replace flip assembly. If flex connector is at fault, proceed to d. If connection is not at fault, proceed to b.
	b) Flip assembly defective.	Temporarily replace the flip assembly with a known good assembly. If fault has been cleared, reassemble with the new flip assembly. If fault not cleared, proceed to c.
	c) Antenna assembly defective.	Check to make sure the antenna is installed correctly. If the antenna is installed correctly, substitute a known good antenna assembly. If this does not clear the fault, reinstall the original antenna assembly and proceed to d.
	d) Transceiver board assembly defective.	Replace the transceiver board assembly (refer to 1c). Verify that the fault has been cleared and reassemble with the new transceiver board assembly.
7. Phone does not sense when flip is opened or closed (usually indicated by inability to answer incoming calls by opening the flip, or inability to make outgoing calls).	a) Flip assembly defective.	Temporarily replace the flip assembly with a known good assembly. If fault has been cleared, reassemble with the new flip assembly. If fault not cleared, proceed to b.
	b) Transceiver board assembly defective.	Replace the transceiver board assembly (refer to 1c). Verify that the fault has been cleared and reassemble the unit with the new transceiver board assembly.
8. Vibrator feature not functioning.	Transceiver board assembly defective.	Replace the transceiver board assembly (refer to 1c). Verify that the fault has been cleared and reassemble the unit with the new transceiver board assembly.
9. Internal Charger not working.	Faulty charger circuit on transceiver board assembly.	Test a selection of batteries in the rear pocket of the desktop charger. Check LED display for the charging indications. If these are charging properly, then the internal charger is at fault. Replace the transceiver board assembly (refer to 1c). Verify that the fault has been cleared and reassemble the unit with the new transceiver board assembly.
10. Real Time Clock resetting when standard battery is removed.	Lithium button cell in the display board may be depleted.	Refer service to a Level 3 service center for replacement.

## Programming: Software Upgrade and Flexing

Contact your local technical support engineer for information about equipment and procedures for flashing and flexing.

## Part Numbers

The following information is provided as a reference for the parts associated with V3m telephones.

## Related Publications

<b>Motorola V3m User's Guide, Verizon, English/Spanish</b>	6809501A90
<b>Motorola V3m User's Guide, generic, English/Spanish</b>	6809501A43

### Exploded View Diagram

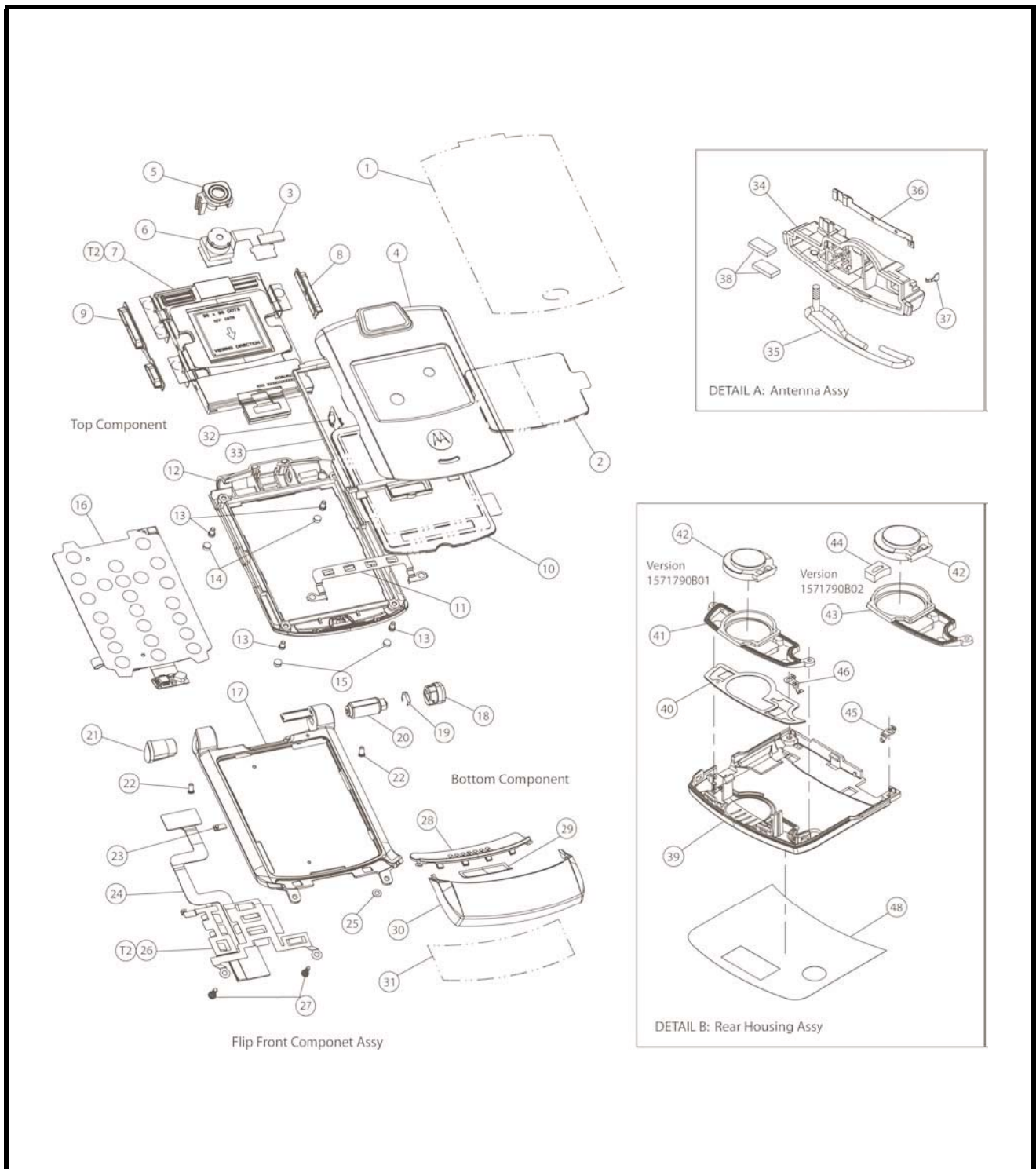

052008o

Figure 50. Exploded View Diagram

## Exploded View Parts List

Table 3. Exploded View Parts List

Item	Part Number	Description	Item	Part Number	Description
1	1188679Y01	Liner, Protective Cover	25	3587505Y01	Mic Screen
2	6171833B01	CLI Lens	26	3971543C01	Contact, Grounding Boot Strap
3	1471770B01	Camera Insulator Cushion	27	0371764B01	Screw, Gatwick, Pan Head
4	0771765B02 0771765B03 0771765B05 0771765B06	Flip Outer Ass'y Pink Flip Outer Ass'y Silver/Black Flip Outer Ass'y Fire Red Flip Outer Ass'y Cherry Red	28	1571787B02 1571787B03	Housing, Front Ant Cover, Silver Housing, Front Ant Cover, Black
5	0571690B01	Grommet, Upper Camera	29	3587330Y01	Grill Screen
6	8471774B01 8471774B02	Camera	30	1571786B02 1571786B04 1571786B05 1571786B07 1571786B09	Housing, Front Ant Cover, Pearl Gray Housing, Front Ant Cover, Orchid Pink Housing, Front Ant Cover, Silver Housing, Front Ant Cover, Fire Red Housing, Front Ant Cover, Cherry Red
7	7271134C02 7271134C04	LCD Module	31	1188679Y02	Liner, Antenna, Outer
8	3871811B01	Button VR	32	4271691B01	Contact, Ground, Hinge
9	387180B01	Button, Volume Control	33	0571694B02	Gasket, Display
10	6171773B01	Lens, Main Display	34	1571801B01	Housing, Bladder
11	3971851B01	Contact, Grounding Flip Boot Strap	35	8571975B01	Antenna, Main
12	1571777B01 1571777B02	Housing, Flip Inner Ass'y Silver Housing, Flip Inner Ass'y Black	36	8571977B01	Antenna, GPS
13	0387726M02	Screw, Pan head	37	8587839Y01	Antenna, Bluetooth
14	3271771B01	Bumper Knuckle	38	3987839Y01	Contact, Speaker
15	3271188C01 3271188C02	Bumper Nose Gray Bumper Nose Black	39	1571403D02 1571403D04 1571403D05 1571403D07 1571403D08	Housing, Rear, Pear Gray Housing, Rear, Silver Housing, Rear, Orchid Pink Housing, Rear, Fire Red Housing, Rear, Cherry Red
16	8471141C01 8471141C02	Keypad Flex Ass'y	40	3587321Y04	Acoustic Screen
17	1571781B02 1571781B03	Front Housing, Silver Front Housing, Black	41	0590053N01	Grommet
18	1371867B01	Housing End Cap Hinge	42	5088017N02 5088017N06	Speaker
19	4271816B01	Grounding Clip	43	0590053N03/ 0590053N04	Grommet
20	5590242N02	Hinge Cam	44	3271849C01	Acoustic Gasket
21	1371866B01	Housing, End Cap Shaft	45	3971861B01	Right Ground Clip
22	0387726M08	Screw, End Cap Pan Head	46	397419Y01	Left Ground Clip
23	1587841Y01	Light Guide	47		
24	8471775B01	Hinge Flex	48	1188432Z04	Protective Liner

**Table 3. Exploded View Parts List (Continued)**

Item	Part Number	Description	Item	Part Number	Description
					Assembly, Battery door
				SHN9626A	Lustrous Silver
				SHN9672A	Lustrous Silver
				SHN9873A	Dark Pearl Gray
				SHN9874A	Dark Pearl Gray
				SHN9876A	Orchid Pink
				SHN9875A	Orchid Pink
				SHN9976A	Lustrous Silver
				SHN0048A	Dark Pearl Gray
				SHN0112A	Fire Red
				SHN0111A	Fire Red
				SHN0099A	Cherry Red
				SHN0140A	Cherry Red
				SHN0210A	Dark Pearl Gray
				SHN0341A	Cherry Red

The "Parts Replacement" section on page 7 provides information about ordering replacement parts.



*There is a danger of explosion if the Lithium Ion battery pack is replaced incorrectly. Replace only with the same type of battery or equivalent as recommended by the battery manufacturer. Dispose of used batteries according to the manufacturer's instructions.*

---

## Accessories

**Table 4. Accessories**

Part Description	Part Number
Headset, FM stereo radio	SYN8609
Headset, with send/end button	SYN8419
Headset, retractable	SYN8284
Neckloop, hands-free (compatible with T-coil hearing aids)	SYN7875
Holster	SYN8454





**A**

alert setting indicator 14  
alert settings 16  
antenna, removing and replacing 25

**B**

battery  
    function 16  
    gauge 16  
    removing 18  
battery housing  
    removing 18  
battery level indicator 13

**C**

caller ID 11  
camera assembly, removing and replacing 37  
Canadian Interference-Causing Equipment regulations 5  
copyrights  
    computer software 6

**D**

disassembly 18

**E**

exploded view diagram 60  
exploded view parts list 61

**F**

FCC rules 5  
features  
    caller ID 11  
    text entry 11  
    Wireless Access Protocol (WAP) 11  
flip assembly, removing and replacing 28  
flip display module assembly, removing and replacing 38

**H**

hinge assembly, removing and replacing 40

**I**

identification 56  
    product 5  
in use indicator 13  
indicators  
    alert setting 14

battery level 13  
    in use 13  
    message waiting 13  
    roam 13  
    signal strength 13  
    voice message waiting 14

Introduction 5

**M**

memory card  
    removing 20  
menu  
    structure diagram 15  
message waiting indicator 13

**N**

names  
    product 5

**O**

operation  
    controls, indicators, and I/O 12  
operation, general 12  
overview, product 10

**P**

part numbers  
    accessories 63  
parts 59  
    exploded view diagram 60  
    exploded view parts list 61  
product  
    identification 5  
    names 5  
product overview 10  
    features 10  
publications, related 59

**R**

rear housing  
    removing 21  
regulatory agency compliance 5  
related publications 59  
removing  
    antenna 25  
    battery 16, 18  
    battery housing 18  
    camera assembly 37

---

- flip assembly 28
- flip display module assembly cover 38
- hinge assembly 40
- memory card 20
- rear housing 21
- transceiver board assembly 27

replacement parts

- ordering 7

replacing

- antenna 25
- battery 18
- camera assembly 37
- flip assembly 28
- flip display module assembly 38
- hinge assembly 40
- rear housing 21
- transceiver board assembly 27

roam indicator 13

## S

service manual

- about 6
- audience 6
- conventions 7
- scope 6

service policy 7

- customer support 7
- out of box failure 7
- product support 7

shut down

- upon battery removal 16

signal strength indicator 13

SIM card

- personality transfer 56

specifications 9

support

- customer 7
- product 7

## T

text entry 11

tools and test equipment 17

transceiver board assembly, removing and replacing 27

troubleshooting 57

## U

user interface diagrams 15

## V

voice message waiting indicator 14

## W

warranty service 7

wireless access protocol (WAP) 11





**MOTOROLA**