



MOTOROLA

Level 1-2 Service Manual

C257/C261

Dual Band Wireless Telephone



Rev. 1.03

C257/C261
GSM 900/1800
GSM850/1900

Table of Contents

Introduction	3
Product Identification	3
Product Names	3
Product Changes	3
Regulatory Agency Compliance	3
Computer Program Copyrights	4
About This Service Manual	4
Warranty Service Policy	5
Parts Replacement	6
Specifications (C257/C261)	7
Product Overview	9
Features	9
General Functions	11
Controls, Indicators, and Input/Output (I/O) Connectors	11
User Interface Menu Structure	13
Battery Function	14
Operation	14
Tools and Test Equipment	14
Disassembly	15
Removing and Replacing the Battery	16
Removing and Replacing the SIM Card	17
Removing and Replacing the Back Cover, the Vibrator Module, and Various Rubber Bits	17
Removing and Replacing the Transceiver Board, the Keypad, and the Antenna Module ..	21
Removing and Replacing the Keypad PCB	22
Removing and Replacing the LCD Module	23
Removing and Replacing the Camera Shielding, the Microphone, and the Camera Module ..	25
Subscriber Identity Module (SIM) and Identification Label	27
SIM	27
Identification	27
Troubleshooting	29
Manual Test Mode	29
Manual Test Mode Commands	29
C257/C261 Troubleshooting Chart	30
Programming: Software Upgrade and Flexing	31
Part Number Charts	32
Exploded View Parts List	34
Accessories	37
Index	Index-1

Introduction

Motorola® Inc. maintains a worldwide organization that is dedicated to provide responsive, full-service customer support. Motorola products are serviced by an international network of company-operated product care centers as well as authorized independent service firms.

Available on a contract basis, Motorola Inc. offers comprehensive maintenance and installation programs that enable customers to meet requirements for reliable, continuous communications. To learn more about the wide range of Motorola service programs, contact your local Motorola products representative or the nearest Customer Service Manager.

Product Identification

The model number on a label (usually on the housing) identifies Motorola products. Use the entire model number when inquiring about the product. Numbers are also assigned to chassis and kits.

Use these numbers when requesting information or ordering replacement parts.

Product Names

Product names are listed on the front cover. Product names are subject to change without notice. Some product names, as well as some frequency bands, are available only in certain markets.

Product Changes

When electrical, mechanical or production changes are incorporated into Motorola products, a revision letter is assigned to the chassis or kit affected, for example: -A, -B, or -C, and so on. The chassis or kit number, complete with revision number is imprinted during production. The revision letter is an integral part of the chassis or kit number and is also listed on schematic diagrams, and printed circuit board layouts.

Regulatory Agency Compliance

This device complies with Part 15 of the FCC Rules. Operation is subject to the following conditions:

- This device may not cause any harmful interference, and this device must accept interference received, including interference that may cause undesired operation
- This class B device also complies with all requirements of the Canadian Interference-Causing Equipment Regulations (ICES-003). Cet appareil numérique de la classe B respecte toutes les exigences du Règlement sur le matériel brouilleur du Canada.

Computer Program Copyrights

The Motorola products described in this manual may include Motorola computer programs stored in semiconductor memories or other media that are copyrighted with all rights reserved worldwide to Motorola. Laws in the United States and other countries preserve for Motorola, Inc. certain exclusive rights to the copyrighted Introduction computer programs, including the exclusive right to copy, reproduce, modify, decompile, disassemble, and reverse-engineer the Motorola computer programs in any manner or form without Motorola's prior written consent. Furthermore, the purchase of Motorola products shall not be deemed to grant either directly or by implication, estoppel, or otherwise, any license or rights under the copyrights, patents, or patent applications of Motorola, except for a nonexclusive license to use the Motorola product and the Motorola computer programs with the Motorola product.

About This Service Manual

Using this service manual and the suggestions contained in it assures proper installation, operation, and maintenance of C257/C261 telephones. Refer questions about this manual to the nearest Customer Service Manager. This manual contains mechanical service information required for the equipment described and is current as of the printing date.

Audience

This document aids service personnel in testing and repairing C257/C261 telephones. Service personnel should be familiar with electronic assembly, testing, and troubleshooting methods, and with the operation and use of associated test equipment.

Scope

This manual provides basic information relating to C257/C261 telephones, and also provides procedures and processes for repairing the units at Level 1 and 2 service centers, including:

- Unit swap out
- Repairing of mechanical faults
- Basic modular troubleshooting
- Testing and verification of unit functionality

Initiate warranty claims and send faulty modules to Level 3 or 4 repair centers.

Conventions

Special characters and typefaces, listed and described below, are used in this publication to emphasize certain types of information.



Note: Emphasizes additional information pertinent to the subject matter.



Caution: Emphasizes information about actions that may result in equipment damage.



Warning: Emphasizes information about actions that may result in personal injury.



Keys to be pressed are represented graphically. For example, instead of "Press the Menu Key", you will see "Press ".

Information from a screen is shown in text as similar as possible to what appears in the display. For example, ALERTS or ALERTS.

Information that you need to type is printed in **boldface** type.

Warranty Service Policy

The product is sold with the standard 12-month warranty terms and conditions. Accidental damage, misuse, and extended warranties offered by retailers are not supported under warranty.

Non-warranty repairs are available at agreed fixed repair prices.

Out of Box Failure Policy

The standard out of box failure criteria applies. Customer phones that fail very early on after the date of sale are to be returned to Manufacturing for root cause analysis, to guard against epidemic criteria. Manufacturing to bear the costs of early life failure.

Product Support

The customer's original phones will be repaired but not refurbished as standard. Appointed Motorola Service Hubs will perform warranty and non-warranty field service for level 2 (assemblies) and level 3 (limited Transceiver component). Motorola High Tech Centers will perform level 4 (full component) repairs.

Customer Support

Customer support is available through dedicated Call Centers and in-country help desks. Product-Service training should be arranged through the local Motorola Support Center.

Parts Replacement

When ordering replacement parts or equipment, include the Motorola part number and description used in the service manual. When the Motorola part number of a component is not known, use the product model number or other related major assembly along with a description of the related major assembly and of the component in question. In the U.S.A., to contact Motorola, Inc. on your TTY, call: 800-793-7834

Accessories and Aftermarket Division (AAD)

Replacement parts, test equipment, and manuals can be ordered from AAD. For EMEA spare parts call +49 461 803 1638. For Asia spare parts call +65 648 62995.

U.S.A.

Phone: 800-422-4210

FAX: 800-622-6210

Outside U.S.A.

Phone: 847-538-8023

FAX: 847-576-3023

Specifications (C257/C261)

General Functions	Specification
Dimensions	109.85*49.95*14.95mm
Weight	93g
External LCD	65K color TFT, Active area 28.032 x 35.04mm, Pixel Resolution: 128(RGB)x160
Sub-LCD	N/A
Band	"EGSM/DCS" or "GSM850/PCS"
Battery	820mAh Li Ion battery
Product type	Candy Bar
Antenna	Internal
Frequency Range (EGSM)	Tx 880-915MHz, Rx 925-960MHz
Frequency Range (DCS)	Tx 1710-1785MHz, Rx 1805-1880MHz
Frequency Range (GSM850)	Tx 824-849MHz, Rx 869-894MHz
Frequency Range (PCS)	Tx 1850-1910MHz, Rx 1930-1990MHz
Channel Spacing	200KHz
Channels	EGSM 174 DCS 374 channels
Modulation	GMSK at BT=0.3
Transmitter Phase Accuracy	5 degrees RMS, 20 degrees peak
Duplex spacing	45MHz GSM, 95MHz DCS
Frequency Stability	+/- 0.1ppm of downlink frquency (RX)
Operating voltage	3.53V ~ 4.2V
Average Transmit Current	Power Level 5: 280mA, Power Level 19: 115mA at DTX off
Average Standby Current	DRX2: 6.5mA, DRX9: 3mA
Temperature Range	-20°C to 55°C

Transmitter Functions	Specification
RF Power Output	32.5 dBm nominal GSM900 30 dBm nominal DCS1800 32.5 dBm nominal GSM850 29.5 dBm nominal PCS1900
Output Impedance	50 ohm (TYP)
Spurious Emissions	-36 dBm from 0.1 to 1GHz, -30 dBm from 1 to 4GHz

Receiver Functions	Specification
Receiver Sensitivity	-107 dBm GSM 850/GSM900 -106 dBm DCS1800/PCS1900
RX Bit Error Rate (100K bits) type II	<2%
Channel Hop Time	500 microseconds
Time to Camp	Approximately 6~10 Second

Speech Coding Functions	Specification
Speech Coding Type	Regular pulse excitation/linear predictive coding with long term prediction (PRE LPC with LTP)
Bit Rate	13.0 Kbps
Frame Duration	20 ms
Block Length	260 bits
Classes	Class 1 bits =182 bits; Class 2 bits = 78 bits
Bit Rate with FEC Encoding	22.8 Kbps

Product Overview

The Motorola C257/C261 features a global system for mobile communications wireless interface and general packet radio service (GPRS) transport technology. It also features a simplified icon and graphical user interface (UI) for easier operation in addition to short message service text messaging (SMS), speed dialing, quick dialing, an alarm, a calculator, games, and an address book. The C257/C261 is a dual-band phone that allows for roaming within the EGSM900 / DCS1800 or GSM850 / PCS 1900.

C257/C261 telephones support GPRS and SMS in addition to traditional circuit switched transport technologies. GPRS, where available, provides substantial increases in mobile data communications performance and the efficient use of radio spectrum. Data transmission rates for GSM networks can potentially increase from the current rate of 9.6 kbps up to a theoretical maximum of 171.2 kbps. An increased data rate is by no means the only benefit provided by GPRS. A key advantage is the provision of a permanent virtual connection to the network. This "always on" connection is possible because GPRS uses packet data transfer so that, for example, email can be downloaded in "background mode." There is no need for the user to reconnect before requesting a service, eliminating connection set-up delays and adding convenience and immediacy to data services access. The "virtual" nature of this connection means that network resources are not consumed during periods when a user is not actually sending or receiving data.

The telephones are made of polycarbonate plastic with a metal enclosure. The display and speaker, as well as the 17-key keypad, transceiver printed circuit board (PCB), microphone, charger and headphone connectors, and power button are contained within the candy bar form-factor housing. The user-replaceable 920 mAh Lithium-Ion (Li-Ion) battery provides up to 180 minutes of talk time with up to 250 hours of standby time¹. The phone accepts 3V mini subscriber identity module (SIM) cards that fit into the SIM holder next to the battery. These telephones feature a 128 x 160 pixel high-resolution color graphics display and an internal antenna.

Features

C257/C261 telephones use advanced, self-contained, sealed, custom integrated circuits to perform the complex functions required for GSM GPRS communication. Aside from the space and weight advantage, microcircuits enhance basic reliability, simplify maintenance, and provide a wide variety of operational functions.

Features available in this family of telephones include:

- A 128 x 160 pixel high-resolution color graphics display
- Internal antenna
- Caller line identification (CLI) (Network, subscription and SIM card or service provider dependent feature. Not available in all areas.)
- Lower voltage technology that provides increased standby and talk times
- Extended GSM (EGSM) channels
- Tri-coder/decoder (CODEC) that allows full rate, half rate, and enhanced full rate modes of transmission
- Display animation
- VibraCall[®] vibrating alert
- 5-Way navigation key
- Simplified text entry using iTAP[™] predictive text entry

- SIM Toolkit™ Class 2 (STK) (Network, subscription and SIM card or service provider dependent feature. Not available in all areas.)
- Backlight
- Speed-, Quick- and One-Touch dialing
- Call Forwarding and Holding
- Customized Menus
- Personal management tools calculator with currency converter, real time clock with date, reminders, and caller profiling
- Other features

Caller Line Identification

Upon receipt of a call, the calling party's phone number is compared to the phone book. If the number matches a phone book entry, that name will be displayed. If there is no phone book entry, the incoming phone number will be displayed. In the event that no caller identification information is available, an incoming call message is displayed.

Simplified Text Entry

The C257/C261 features iTAP™ predictive text entry. Press a key to generate a character and a dynamic dictionary uses this to build and display a set of word or name options. The iTAP™ feature may not be available on the phone in all languages.

SIM Toolkit™ - Class 2

SIM Application Toolkit is a value-added service delivery mechanism that allows GSM operators to customize the services they offer their customers, from the occasional user who requests sports news and traffic alerts, to a high call time business user who receives stock alerts and checks flight times. Operators can now create their own value-added services menu quickly and easily in the phone.

The customized menu will appear as the first menu and may be updated over-the-air with new services when customers request them.

Other Features

Detailed descriptions of the other features can be found in the appropriate C257/C261 telephone user guides listed in the Related Publications section at the end of this manual.

General Functions

Controls, Indicators, and Input/Output (I/O) Connectors

The C257/C261 phone's controls are located on the front side of the device and on the keyboard as shown in below. Indicators icons are displayed on the LCD.

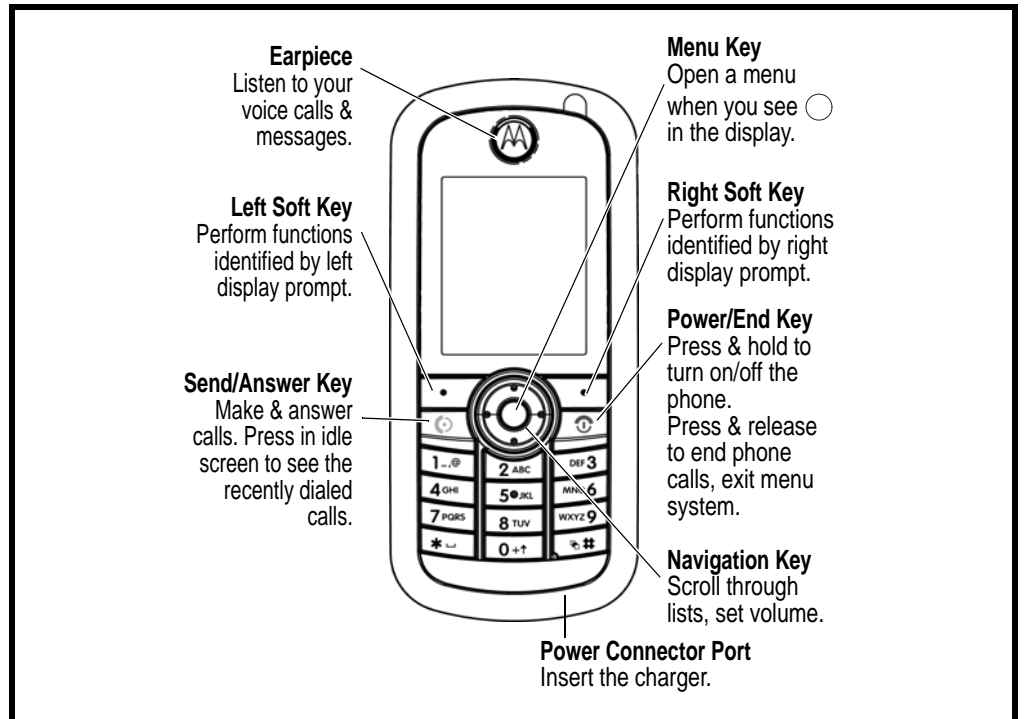

Figure 1. Phone Controls

Menu Navigation

C257/C261 telephones are equipped with a simplified icon and graphical-based user interface. See the table below for details of the C257/C261 menu structure. A five-way navigation key allows you to move easily through menus and confirm your selection.

Liquid Crystal Display (LCD)

The LCD provides a multicolor backlit color display with user-adjustable contrast settings for optimum readability in all light conditions. The bit-map 128 x 160 pixel display includes up to 3 lines of text, 1 line of icons, and 1 line of prompts.

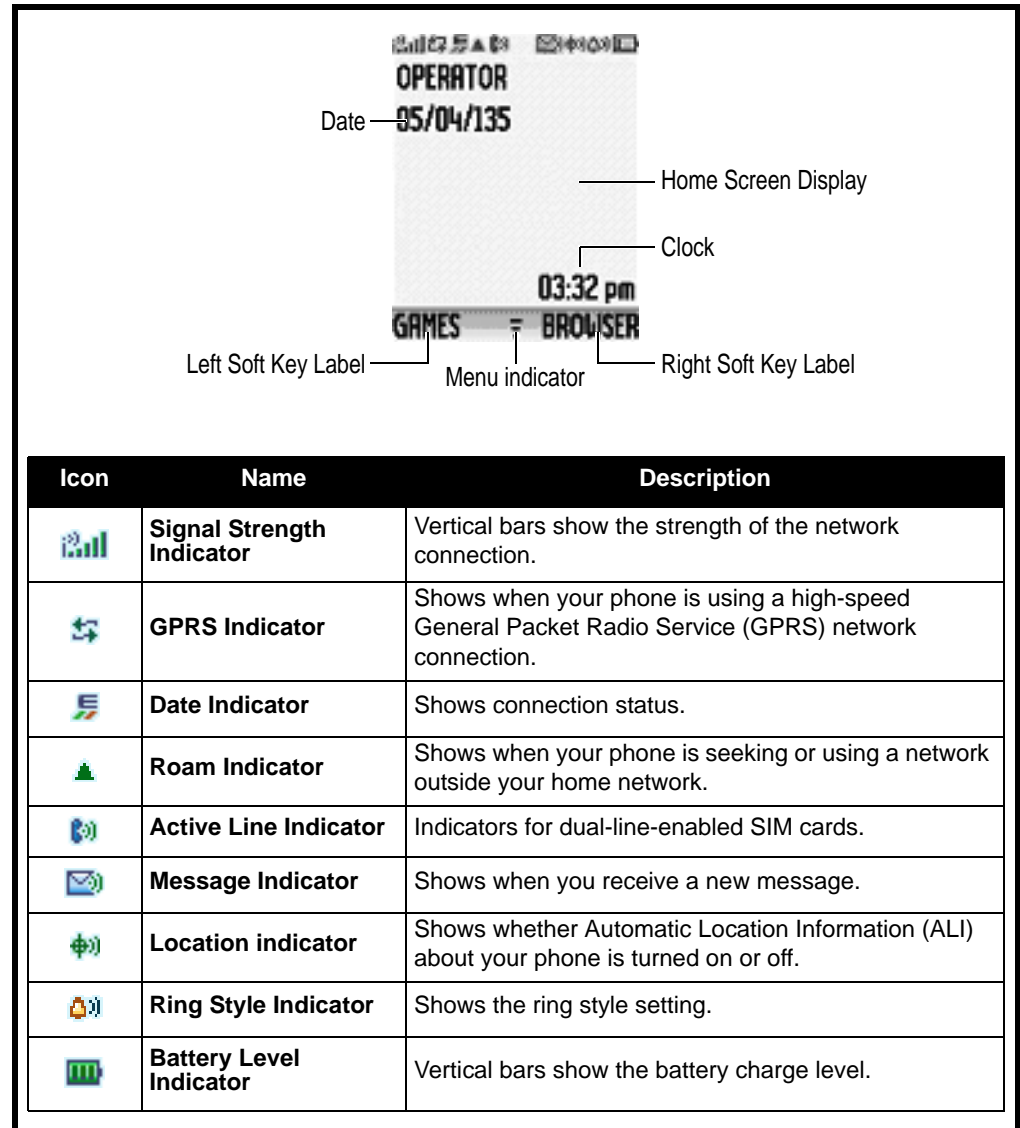











Figure 2. LCD Icons

User Interface Menu Structure

The table below shows a portion of the C257/C261 telephone menu structure.

Menu Map

<ul style="list-style-type: none">  Phonebook  Recent Calls <ul style="list-style-type: none"> • Received calls • Dialed Calls • NotePad • Call Times • Call Cost  Message <ul style="list-style-type: none"> • Create • Inbox • Draft • Outbox • Quick Notes • Voicemail • Browser Msgs • Info Services • MMS Templates  Office Tools <ul style="list-style-type: none"> • Calculator • MyMenu • Alarm Clock • Stop Watch • Chat • Dialing Services • IM  Games & Apps 	<ul style="list-style-type: none">  Web Access <ul style="list-style-type: none"> • Start Browser • Web Shortcut • Go to URL • Browser Setting • Stored Pages • History • General Setting  Multimedia <ul style="list-style-type: none"> • Pictures • Sounds • Camera (For C261)  Personalise <ul style="list-style-type: none"> • Home Screen • Main Menu • Colour Setting • Greeting • Wallpaper • Screen Saver • Quick Dial  Settings <ul style="list-style-type: none"> • Ring Style • Call Forward • In Call Setup • Initial Setup • Phone Status • Headset • Network • Security
--	--

* Optional Network, SIM card, or subscription-dependent features.

Figure 3. Telephone Menu Structure

Battery Function

The telephone displays a battery charge indicator icon in the idle screen to indicate the battery charge level. The gauge shows four levels: 100%, 66%, 33%, and Low Battery.

Removing the battery causes the phone to shut down immediately and lose any pending work (partially entered phone book entries or outgoing messages, for example).



Note: All batteries can cause property damage and/or bodily injury such as burns if a conductive material such as jewelry, keys, or beaded chains touches exposed terminals. The conductive material may complete an electrical circuit (short circuit) and become quite hot. Exercise care in handling any charged battery, particularly when placing it inside a pocket, purse, or other container with metal objects.



If the battery is removed while receiving a message, the message is lost.



To ensure proper memory retention, turn the phone OFF before removing the battery. Immediately replace the old battery with a fresh battery.

Operation

For detailed operating instructions, refer to the appropriate User Guide listed in the Related Publications section toward the end of this manual.

Tools and Test Equipment

The table below lists the tools and test equipment used on C257/C261 telephones. Use either the listed items or the equivalent.

Table 1: General Test Equipment and Tools

Motorola Part Number ¹	Description	Application
See Table 6	Charger	Used to charge battery and power phone
0180386A82	Antistatic Mat Kit (includes 66-80387A95 antistatic mat, 66-80334B36 ground cord, and 42-80385A59 wrist band)	Provides protection from damage to phone caused by electrostatic discharge (ESD)
-	Antistatic Gloves	Provides protection from damage to phone caused by electrostatic discharge (ESD)
8102430Z04	GSM / DCS / PCS Test SIM	Used to enable manual test mode
6680388B67	Disassembly tool, plastic with flat and pointed ends (manual opening tool)	Used during assembly/disassembly
6680388B01	Tweezers, plastic	Used during assembly/disassembly
-	T5 screw driver	Used with screw driver
-	camera jig	Used to remove a built-in camera (where present)

Table 1: General Test Equipment and Tools

Motorola Part Number ¹	Description	Application
HP34401A ²	Digital Multimeter	Used to measure battery voltage

1. To order in North America, contact Motorola Aftermarket and Accessories Division (AAD) by phone at (800) 422-4210 or FAX (800) 622-6210. Internationally, AAD can be reached by calling (847) 538-8023 or by fax (847) 576-3023.
2. Not available from Motorola. To order, contact Hewlett Packard at (800) 452-4844.



Figure 4. A screwdriver (T5), a pair of tweezers, and a camera jig



Note: This particular camera requires a unique camera jig (pictured on the far right) for disassembly of the camera, where present. You can order this tool from Motorola using the information presented above in Footnote 1.

Disassembly



Many of the integrated devices used in this phone are vulnerable to damage from electrostatic discharge (ESD). Ensure adequate static protection is in place when handling, shipping, and servicing any internal components.



Avoid stressing the plastic in any way to avoid damage to either the plastic or internal components.

Removing and Replacing the Battery



All batteries can cause property damage and/or bodily injury such as burns if a conductive material such as jewelry, keys, or beaded chains touches exposed terminals. The conductive material may complete an electrical circuit (short circuit) and become quite hot. Exercise care in handling any charged battery, particularly when placing it inside a pocket, purse, or other container with metal objects.

1. Ensure the phone is turned off.
2. Press the battery cover release button and then pull it away.

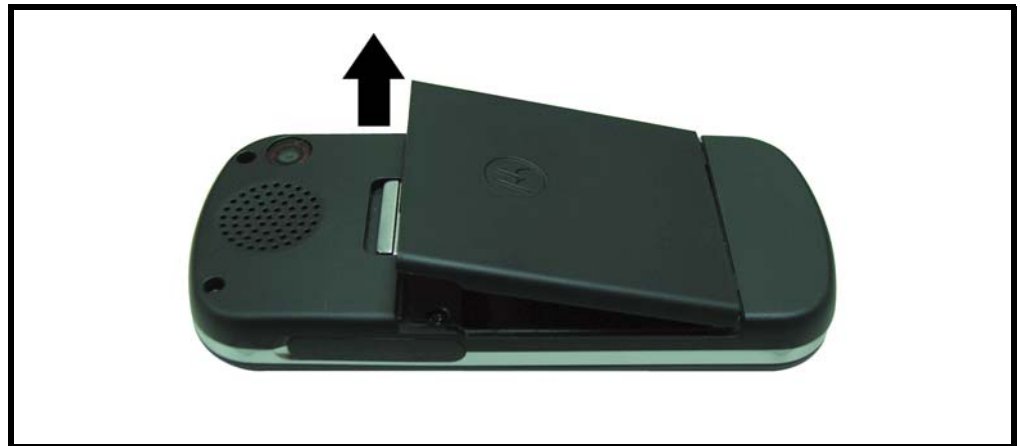

Figure 5. Opening the battery cover

3. Next, pull the battery up and away from the battery compartment.

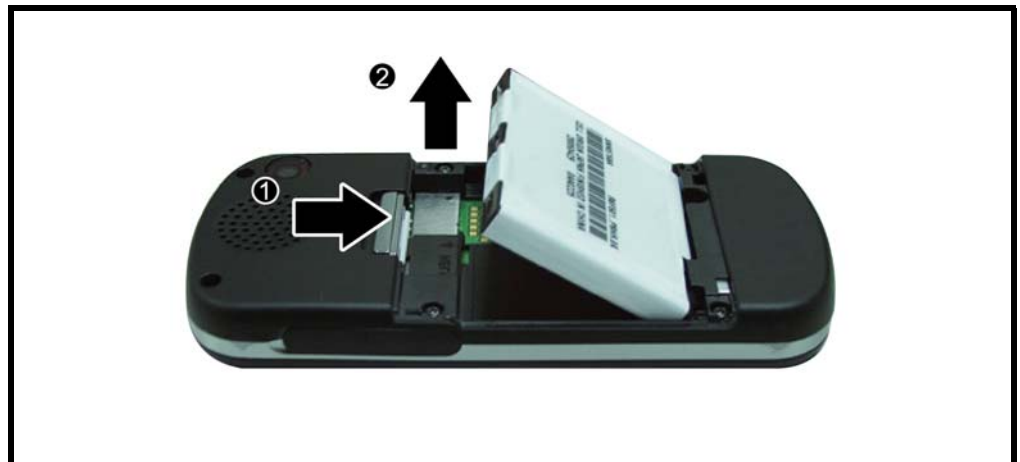

Figure 6. Removing the battery



There is a danger of explosion if the Lithium ion battery is replaced incorrectly. Replace only with the same type of battery or equivalent as recommended by the battery manufacturer. Dispose of used batteries according to the manufacturer's instructions.

4. To replace, insert the battery with the 2 tabs on its bottom end into the battery slots of the phone.
5. Click the battery into place, then slip the battery cover over it.

Removing and Replacing the SIM Card

1. First, remove the battery.
2. Slide out the SIM card from the SIM card bracket.

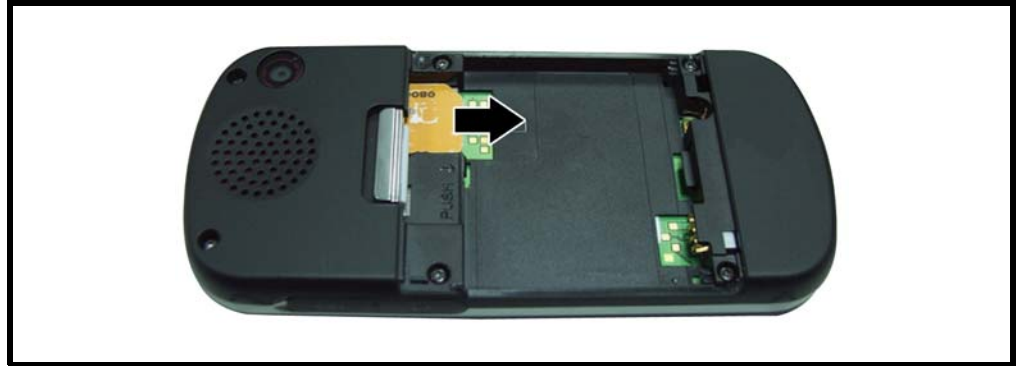

Figure 7. Removing the SIM card

Removing and Replacing the Back Cover, the Vibrator Module, and Various Rubber Bits

1. First, remove the SIM Card.
2. Remove six T5 screws securing the back cover to the front.

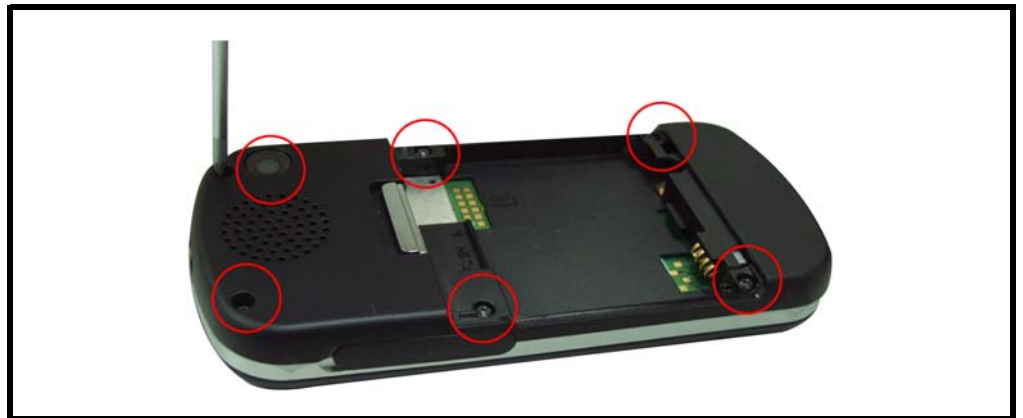

Figure 8. Removing 6 T5 screws (Torque Force = 1.2 kgf-cm)

3. Pry away the back cover from the top left corner.



Figure 9. Prying open the back cover

4. Remove the vibrator module from the inside of the back cover.

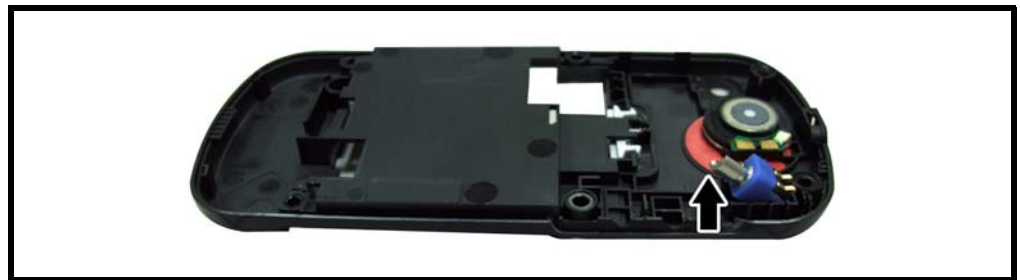

Figure 10. Removing the vibrator module

5. Pry out the speaker.



Figure 11. Removing the speaker



If you remove the sponge from the back cover, you must replace it with a new one.

6. Remove the side rubber.



Figure 12. The side rubber

7. Remove the LED rubber.



Figure 13. The LED rubber

8. Remove the camera rubber.



Figure 14. The camera rubber

9. Remove the speaker rubber.



Take precaution to avoid damaging the speaker connector.

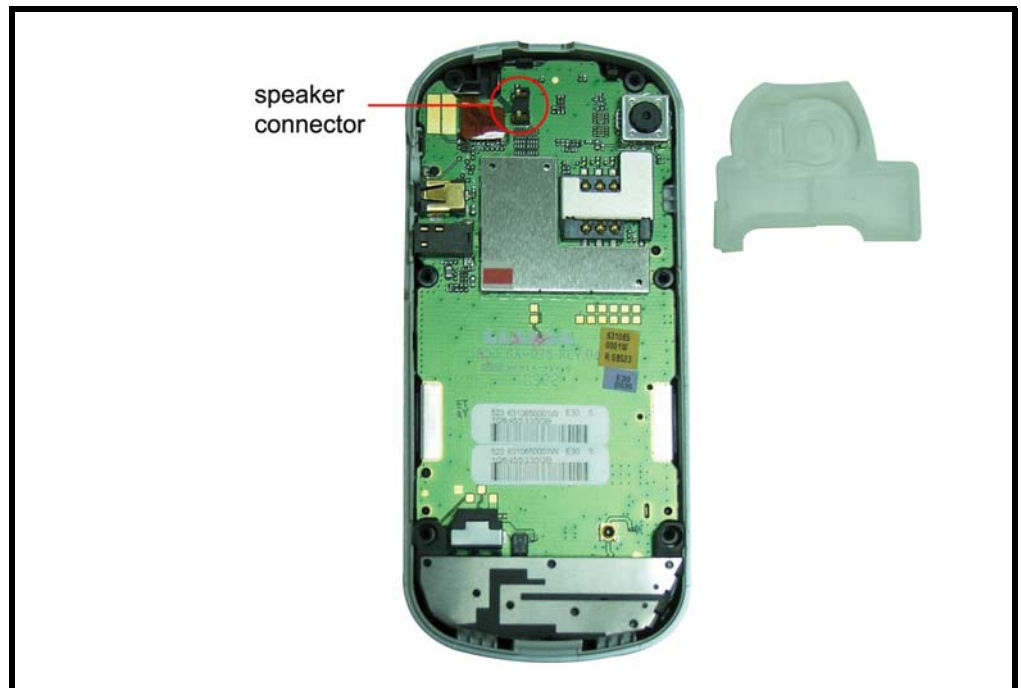

Figure 15. The speaker rubber

Removing and Replacing the Transceiver Board, the Keypad, and the Antenna Module

1. First, remove the back cover, the vibrator module, and various rubber bits.
2. Pry out the transceiver board.

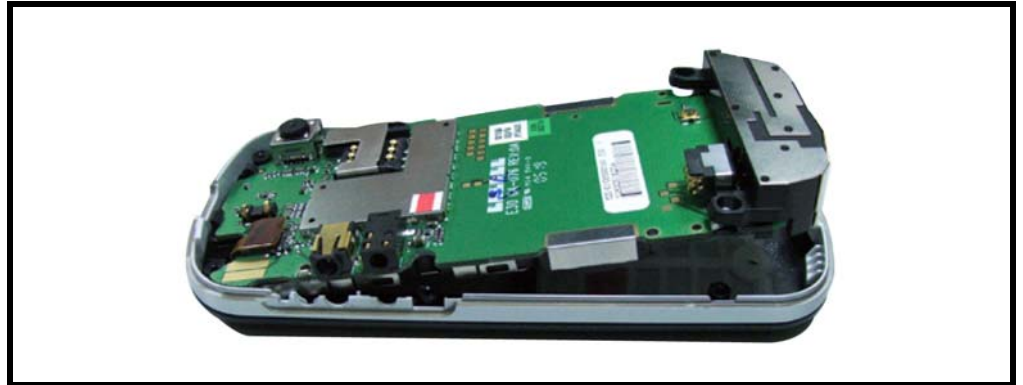

Figure 16. Removing the transceiver board

3. Remove the rubber keypad from the front housing.



Figure 17. The rubber keypad

4. Gently pry the antenna module away from the transceiver board.

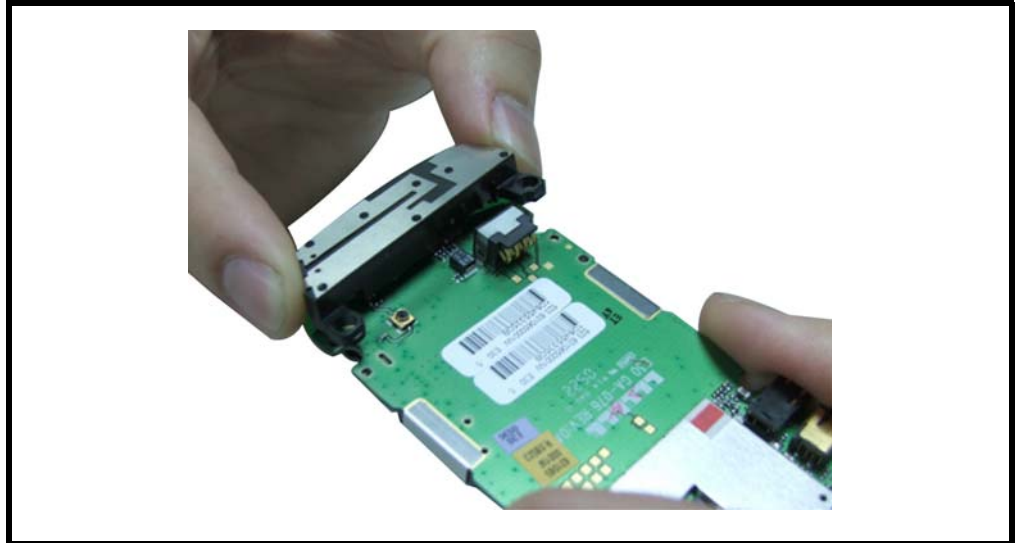

Figure 18. Removing the antenna module

Removing and Replacing the Keypad PCB

1. First, remove the transceiver board, the keypad, and the antenna module.
2. Pry off the two PCB side brackets.

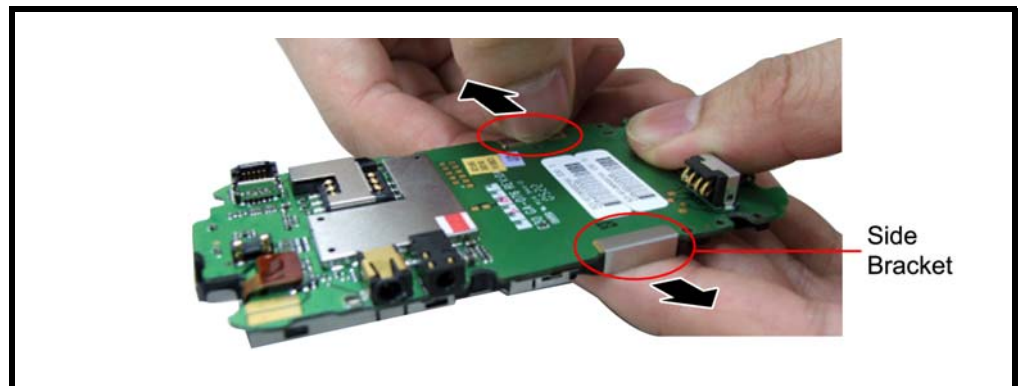

Figure 19. Removing the side brackets

3. Pry off the keypad PCB.

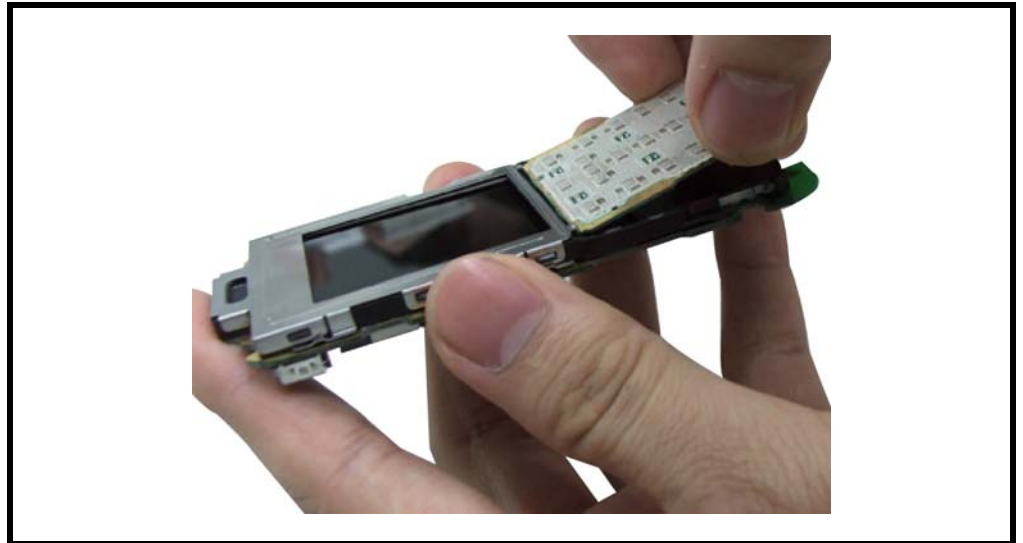

Figure 20. Removing the keypad PCB

Removing and Replacing the LCD Module

1. First, remove the keypad PCB.
2. Remove the LCD holder.

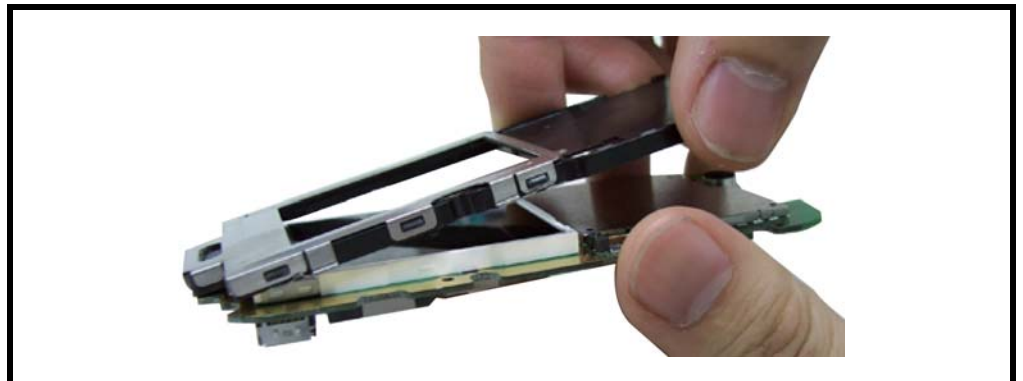

Figure 21. Removing the LCD holder

3. Remove the receiver using a tweezers.

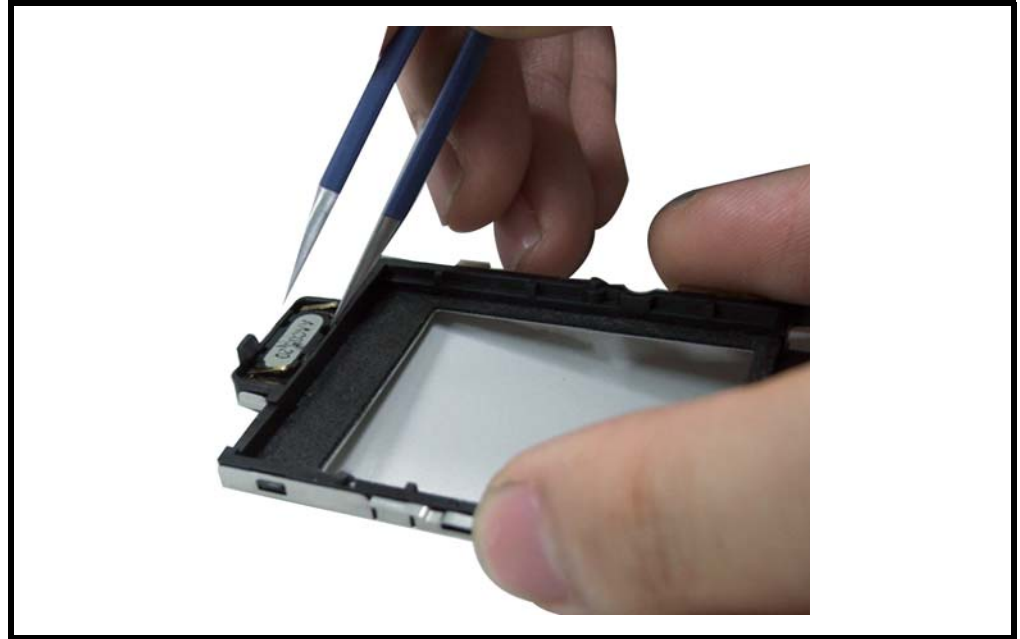

Figure 22. Using tweezers to remove the receiver

4. Very carefully disconnect the board-to-board connector, ensuring the connector doesn't exceed a 10° angle.



Ensure the connector doesn't exceed a 10° angle.

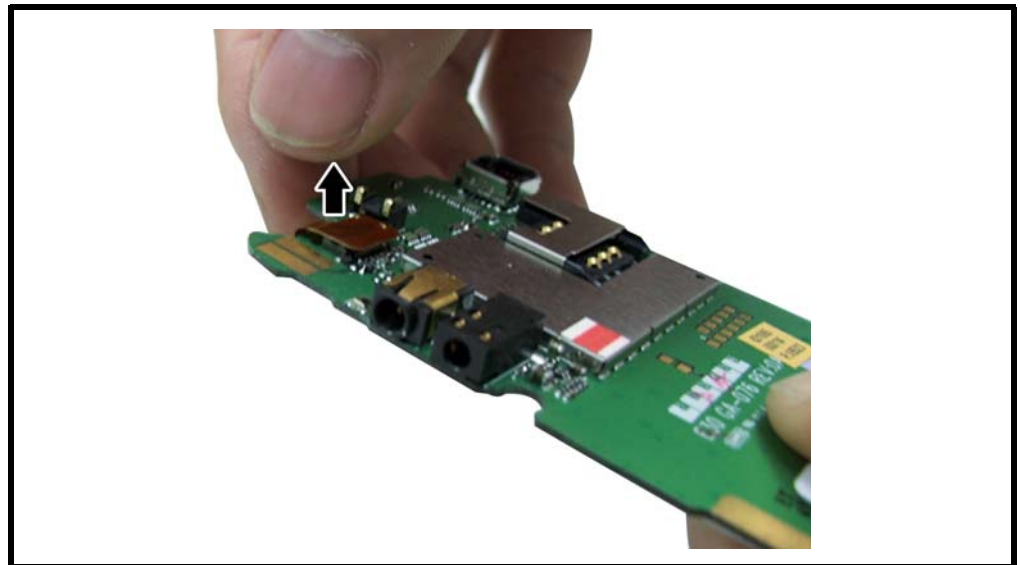

Figure 23. Disconnecting the board-to-board connector

5. Remove the LCD.

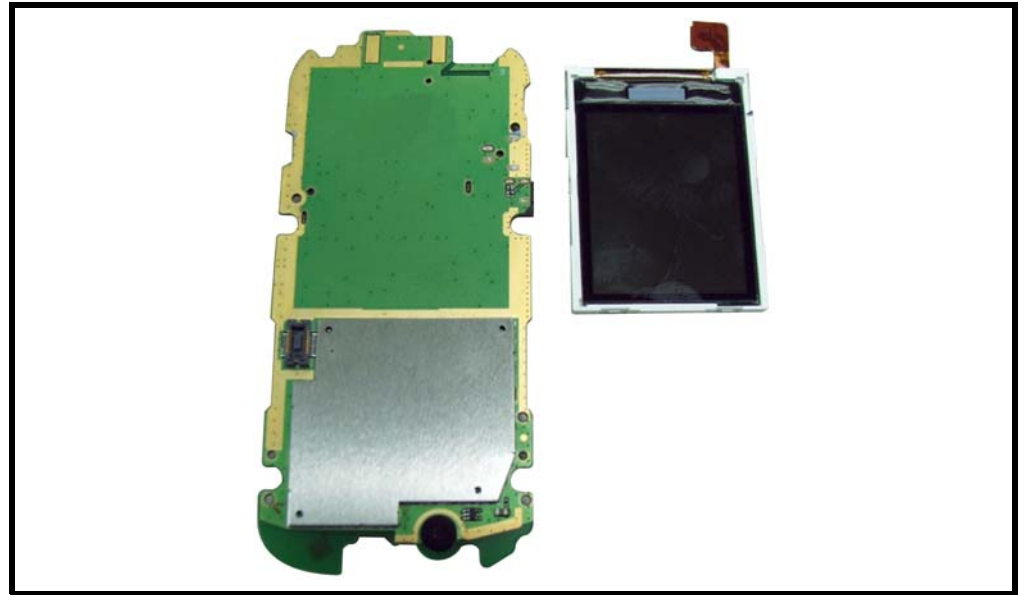

Figure 24. The LCD

Removing and Replacing the Camera Shielding, the Microphone, and the Camera Module

1. First, remove the LCD module.
2. Use tweezers to pry off the camera shielding.



If you remove the camera shielding, you must replace it with a new one.

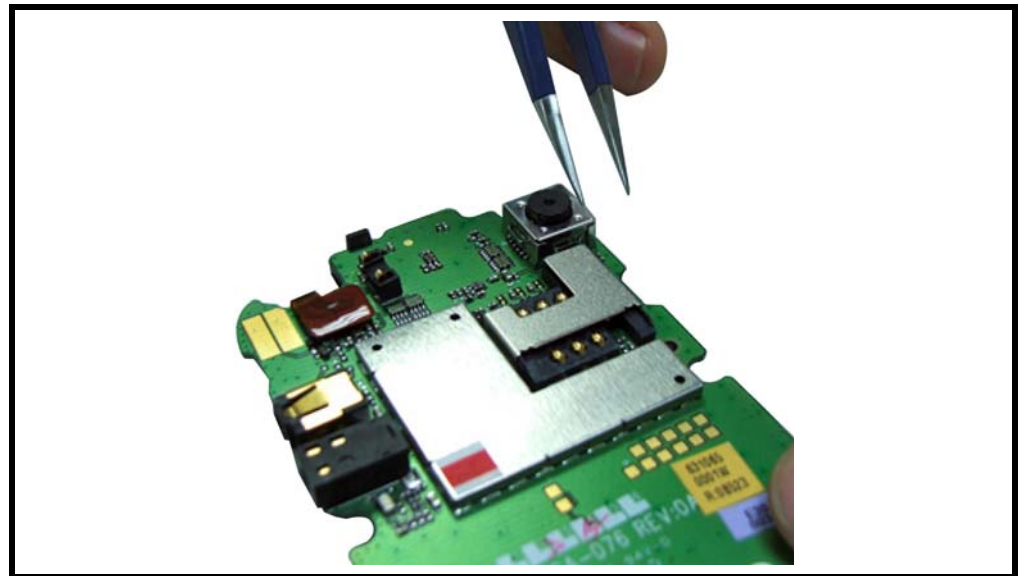

Figure 25. Using tweezers to pry off the camera shielding

- Using a camera jig provided by Motorola, carefully pinch and pull out the camera module.

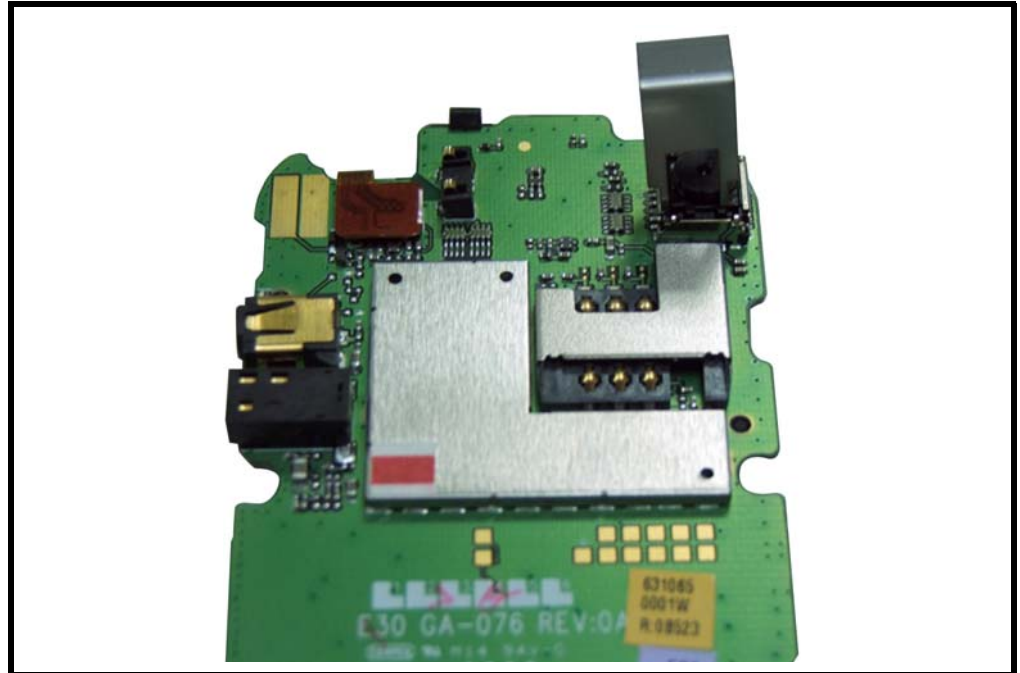

Figure 26. Using a camera jig to remove the camera module

- Pop out the microphone.

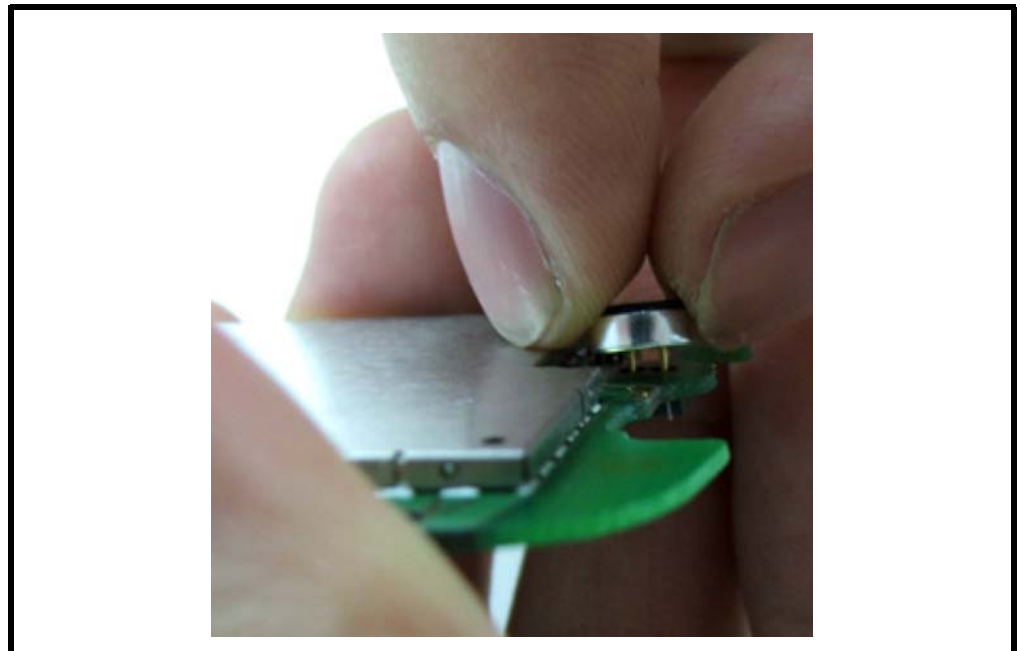

Figure 27. Removing the microphone

Subscriber Identity Module (SIM) and Identification Label

SIM

A SIM is required to access the existing local GSM network, or remote networks when traveling (if a roaming agreement has been made with the provider).

The SIM contains:

- All the data necessary to access GSM services
- The ability to store user information such as phone numbers
- All information required by the network provider to provide access to the network

Identification

Each Motorola GSM phone is labeled with a variety of identifying numbers. The following information describes the current identifying labels.

Mechanical Serial Number (MSN)

- The MSN is an individual unit identity number and remains with the unit throughout its life.
- The MSN can be used to log and track a phone on Motorola's Service Center Database.
- The MSN is divided into 4 sections as shown in Figure 28.

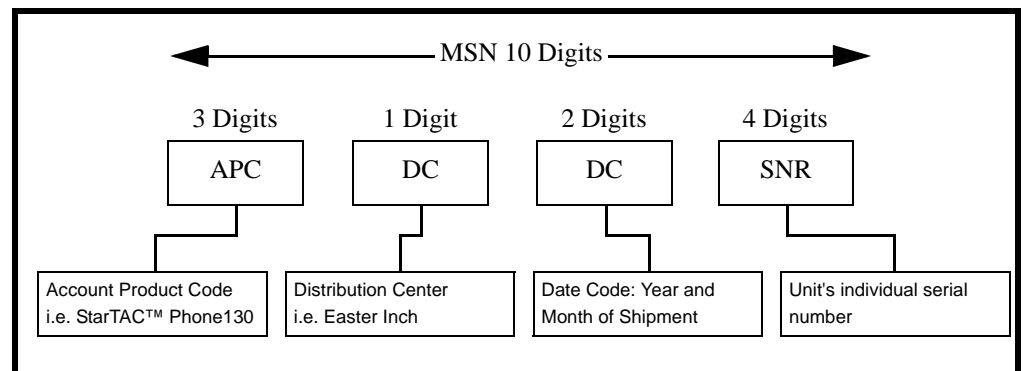

Figure 28. MSN Divisions

International Mobile Station Equipment Identity (IMEI)

The International Mobile Station Equipment Identity (IMEI) number is an individual number unique to the Transceiver and is stored within the unit's memory. The IMEI uniquely identifies an individual mobile station and thereby provides a means for controlling access to GSM networks based on mobile station types or individual units. The full IMEI structure is listed in the table below.

Table 2: IMEI Number Breakdown

TAC	Serial Number	Check Digit
NNXXXXXX	ZZZZZZ	A

Where

TAC Type Allocation Code, formerly known as Type Approval Code

NN Reporting Body Identifier (BAPT or CTIA)

XXXXXX Type Identifier (defined by BAPT or CTIA)

ZZZZZZ Individual unit serial number

Phase 1 = 0.

A Phase 2 & 2+ check digit and is defined as a function of all other IMEI digits

Other label number configurations present are:



- **TRANSCIVER NUMBER:** Identifies the product type. Normally the SWF number. (i.e. V100).
- **PACKAGE NUMBER:** Identifies the equipment type, mode, and language in which the product is shipped.

Troubleshooting

Manual Test Mode

MotorolaC257/C261 telephones are equipped with a manual test mode capability. This allows service personnel to verify functionality and perform fault isolation by entering keypad commands.

To enter the manual test command mode, a GSM/DCS/PCS test SIM must be used.

1. Press and hold  to turn the phone OFF.
2. Remove the battery as described in the procedures.
3. Remove the customer's SIM card from the phone as described in the procedures.
4. Insert the test SIM into the SIM slot.
5. Replace the battery as described in the procedures.
6. Press and hold  to turn the phone ON.

Manual Test Mode Commands

Table 3: Manual Test Commands

Key Sequence	Test Function/Name	Remarks
#02#	Handset information	
#03#	RF information	
#04#	ADC information	
#08#	Engineer Field Test Mode	
#09#	Simple Test mode	
**0102#	FFS format	
**0105#	Disable EFEM mode	
*#06#	IMEI number	

C257/C261 Troubleshooting Chart

Table 4: Level 1 and 2 Troubleshooting Chart

Symptom	Probable Cause	Verification and Remedy
1. Phone will not turn on or stay on.	a) Battery either discharged or defective.	Measure battery voltage across a 50 ohm (>1 Watt) load. If the battery voltage is <3.25 Vdc, recharge the battery using the appropriate battery charger. If the battery will not recharge, replace the battery. If battery is not at fault, proceed to b.
	b) Battery terminals open or misaligned.	Visually inspect the battery terminals on both the battery and the phone. Realign and, if necessary, either replace battery or refer to a Level 3 Service Center for the battery connector replacement. If battery terminals are not at fault, proceed to c.
	c) Keypad defective.	Replace the keypad. Temporarily connect a +3.6 Vdc supply to the battery terminals. Press and hold the PWR button. If phone turns on and stays on, disconnect the dc power source and reassemble with the new keypad.
2. Phone exhibits poor reception or erratic operation such as calls frequently dropping or weak or distorted audio.	Connections to or from lower PCB defective.	Check connection between the antenna and the lower PCB.
3. Display is erratic, or provides partial or no display.	LCM defective.	Replace the LCM. Verify that the fault has been cleared and reassemble the phone with the new LCM.
4. Incoming call alert transducer audio distorted or volume is too low.	Speaker defective.	Replace the speaker as described in the procedures. Verify that the fault has been cleared and reassemble the phone with the new speaker.
5. Phone transmit audio is weak. (usually indicated by called parties complaining of difficulty in hearing voice).	Microphone defective.	Replace the microphone as described in the procedures. Verify that the fault has been cleared and reassemble the phone with the new microphone.
6. Receive audio from earpiece speaker is weak or distorted.	a) Connections to or from lower PCB defective.	Check connection between the antenna and the lower PCB. If the connection is OK, proceed to b.
	b) Earpiece Speaker defective.	Temporarily replace the earpiece speaker with a known good earpiece speaker. Ensure good connection. Place a call and verify improvement in earpiece audio. If fault is cleared, reassemble the phone with the good earpiece speaker.

Table 4: Level 1 and 2 Troubleshooting Chart (Continue)

Symptom	Probable Cause	Verification and Remedy
7. Phone will not recognize or accept SIM card.	SIM card defective.	Check the SIM card contacts for dirt. Clean if necessary, and check if fault has been cleared. If the contacts are clean, insert a known good SIM card into the phone. Power up the phone and confirm that the card has been accepted. If the fault no longer exists, replace the defective SIM card.
8. Keypad not functioning.	Keypad defective.	Use alcohol to wipe the keypad metal dome. Check if fault has been cleared. If the fault is still present, either replace the keypad or refer to a Level 3 Service Center for the keypad metal dome replacement.
9. Vibrator feature not functioning.	a) Vibrator faulty.	Check general condition of vibrator. If it is good, proceed to b.
	b) Vibrator defective.	Replace the defective vibrator.
10. No or weak audio when using headset.	a) Headset plug not fully pushed.	Ensure the headset plug is fully seated in the jack. If the seated is OK, proceed to b.
	b) Headset defective.	Temporarily replace the headset with a known good headset. Ensure good seated. Place a call and verify improvement in headset audio. If fault is cleared, replace the defective headset.
11. Camera module not functioning. (for C261)	Camera module defective.	Replace the camera module as described in the procedures. Verify that the fault has been cleared and reassemble the phone with the new camera module.

Programming: Software Upgrade and Flexing

Contact your local technical support engineer for information about equipment and procedures for flashing and flexing.

Part Number Charts

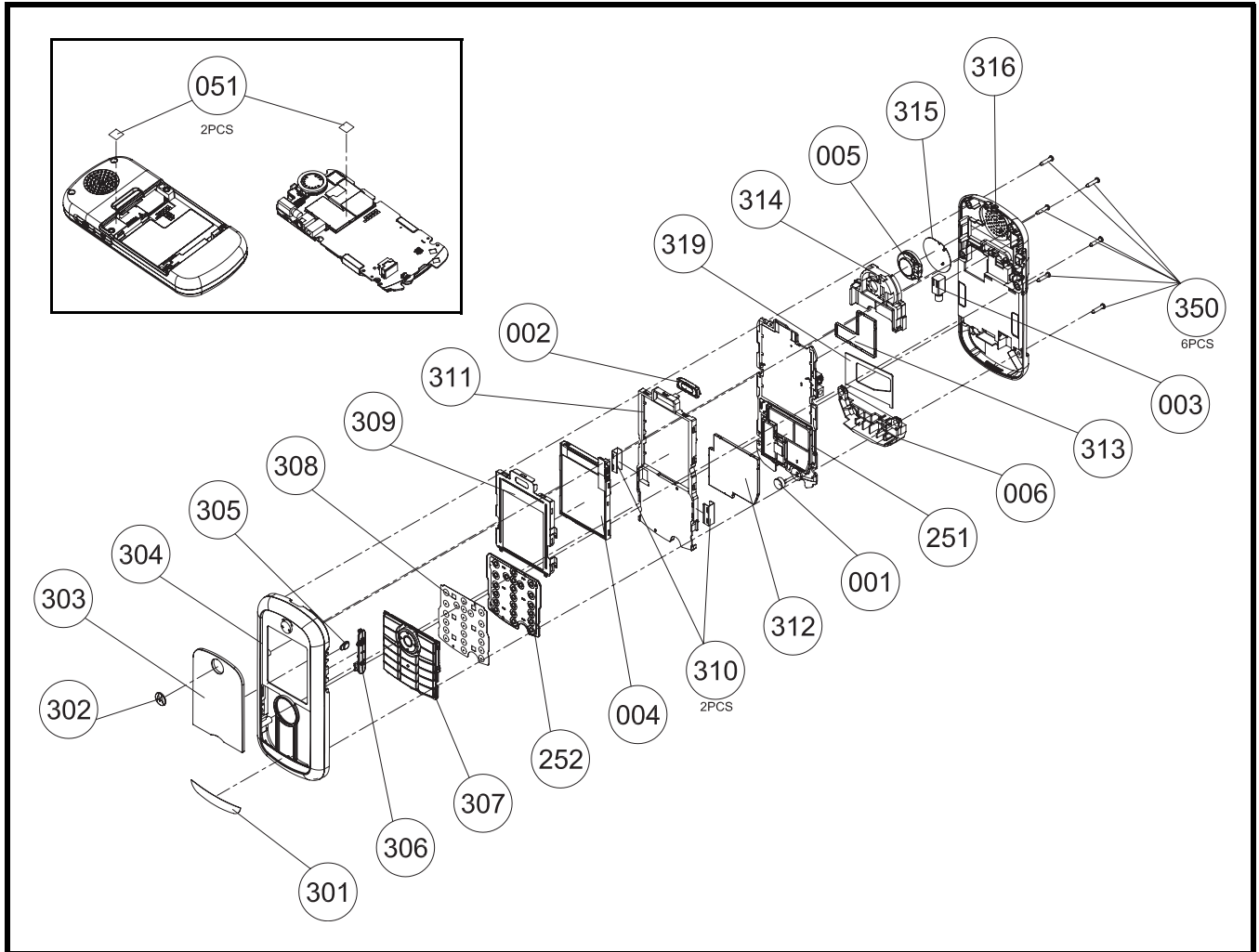

Figure 29. C257 Exploded View Diagram

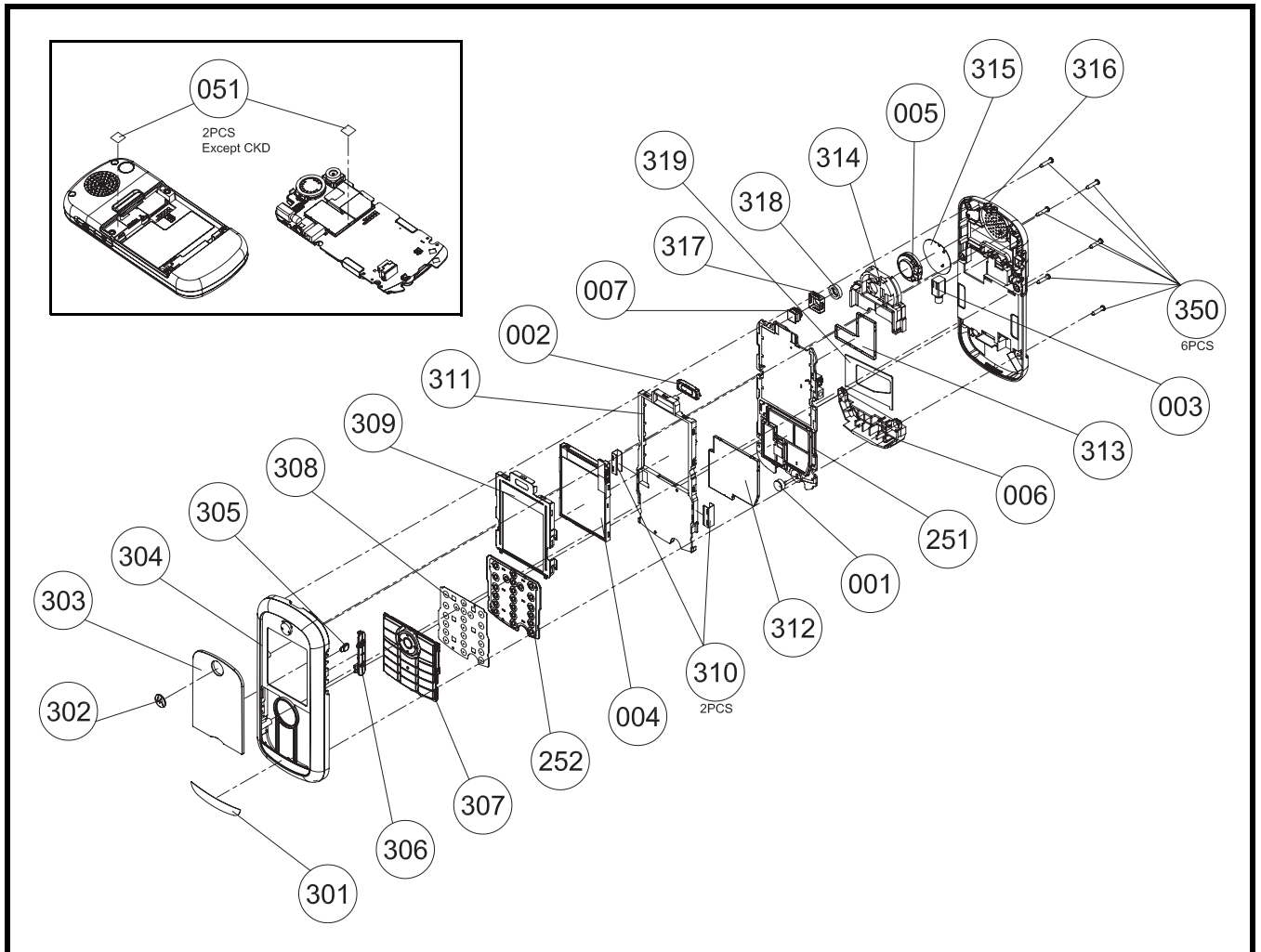

Figure 30. C261 Exploded View Diagram

Exploded View Parts List

Table 5: C257 Exploded View Parts List

Item Number	Part Number	Description	Specification
001	2220602204W	MIC	ACMG6022-02P28-402 ϕ 6 -40dB
002	2240061501W	RECEIVER	SDRP0615FJ04-F1-G 32ohm AAC
003	3930408012W	SPR-VIB	ϕ 4*L8 1.3V LA4-459ED COPAL
004	7630001893W	LCM	TD018THEE3 128*160 TOPPOLY
005	2250160802W	SPEAKER	DMS1608F-06-F2-G 8ohm 16mm AAC
006	2301E28001W	I-ANTENNA	E28 ANT+HOLDER EU
051	82E5803301W	LABEL	E58 WATERPROOF LABEL ϕ 4mm
251	6910653321N	F/WMB 33	E28 GA-076
252	6320400001N	SMT MMI	E30 GS-047
300	5501063001N	ME/PT 33	E28 SILVER
301	3062E28001W	NAMEPLATE	E28-PC-BLACK
302	2545E28001W	MARK	E28-ABS-SILVER-M-LOGO
303	2541E28001W	LCD-LENS	E28-PMMA-CLEAR BLACK
304	2511E28001W	UPP-ASSY	E28-SILVER
305	254AE28001W	LED-LENS	E28-RUBBER-WHITE
306	302BE28001W	RUBBERPAD	E28-TPU-BLACK-AUDIO-DC
307	3104E28011W	DIAL-KEY	E28-P+R-BLACK-E-21KEY
308	3109E28001W	MET-DOME	E28- ϕ 4*170g-21KEY
309	3012E28001W	SHIELDASY	E28-LCD SHIELD+SPONGE ASSY
310	3052E28006W	SHIELD-C	E28-SUS304-13*3*0.2T-LOCK
311	2531E28001W	MID-CASE	E28-NYLON+GF-BLACK
312	3052E28003W	SHIELD-C	E28-SUS301-37.4*35.2*0.15T-RF
313	3052E28004W	SHIELD-C	E28-SUS304-29.9*24.4*0.15T-BB
314	302FE28001W	SPK-GASKE	E28-RUBBER-30.9*37.3*6.65
315	3061E28001W	DUST-PRO	E28-FELT-20.8*19.3
316	2512E28001W	LOW-ASSY	E28-SILVER
319	3037E28001W	MID-SPON	E28-PU-33.04*25.87
350	3501775101W	SCREW_G	PH T5 M1.7*7.5 TP-B KL

Table 6: C261 Exploded View Parts List

Item Number	Part Number	Description	Specification
001	2220602204W	MIC	ACMG6022-02P28-402 ϕ 6 -40dB
002	2240061501W	RECEIVER	SDRP0615FJ04-F1-G 32ohm AAC
003	3930408012W	SPR-VIB	ϕ 4*L8 1.3V LA4-459ED COPAL
004	7630001893W	LCM	TD018THEE3 128*160 TOPPOLY
005	2250160802W	SPEAKER	DMS1608F-06-F2-G 8ohm 16mm AAC
006	2301E28001W	I-ANTENNA	E28 ANT+HOLDER EU
007	7650561001W	CMOS SENS	CM-5610 VGA 6*6*5.3 CHICONY
051	82E5803301W	LABEL	E58 WATERPROOF LABEL ϕ 4mm
251	6910653301W	F/WMB 33	E30 GA-076
252	6320400001W	SMT MMI	E30 GS-047
300	5501083331W	ME/PT 33	E30/E30A RED
301	3062E30001W	NAMEPLATE	E30-PC-BLACK
302	2545E28001W	MARK	E28-ABS-SILVER-M-LOGO
303	2541E28001W	LCD-LENS	E28-PMMA-CLEAR BLACK
304	2511E28002W	UPP-ASSY	E28-RED
305	254AE28001W	LED-LENS	E28-RUBBER-WHITE
306	302BE28001W	RUBBERPAD	E28-TPU-BLACK-AUDIO-DC
307	3104E28011W	DIAL-KEY	E28-P+R-BLACK-E-21KEY
308	3109E28001W	MET-DOME	E28- ϕ 4*170g-21KEY
309	3012E28001W	SHIELDASY	E28-LCD SHIELD+SPONGE ASSY
310	3052E28006W	SHIELD-C	E28-SUS304-13*3*0.2T-LOCK
311	2531E28001W	MID-CASE	E28-NYLON+GF-BLACK
312	3052E28003W	SHIELD-C	E28-SUS301-37.4*35.2*0.15T-RF
313	3052E28004W	SHIELD-C	E28-SUS304-29.9*24.4*0.15T-BB
314	302FE28001W	SPK-GASKE	E28-RUBBER-30.9*37.3*6.65
315	3061E28001W	DUST-PRO	E28-FELT-20.8*19.3
316	2512E30004W	LOW-ASSY	E30-RED
317	3052E30001W	SHIELD-C	E30-R41-8650-CMOS
318	3068E30001W	GASKET	E30-RUBBER- ϕ 8*2.08-CMOS

Table 6: C261 Exploded View Parts List

Item Number	Part Number	Description	Specification
319	3037E28001W	MID-SPON	E28-PU-33.04*25.87
350	3501775101W	SCREW_G	PH T5 M1.7*7.5 TP-B KL



There is a danger of explosion if the Lithium ion battery pack is replaced incorrectly. Replace only with the same type of battery or equivalent as recommended by the battery manufacturer. Dispose of used batteries according to the manufacturer's instructions.

To order parts please use the following Link:

<https://servicelink3.motorola.com>

(Password is required)

For information on ordering parts please contact EMEA at +49 461 803 1638.

Accessories

Table 7: List of Accessories

Description	Part Number
Power Solutions	
Titanium battery 740 mAh Lilon (English label)	SNN5733A
Titanium battery 740 mAh Lilon (PRC label)	SNN5731A
Andonised brown battery 740 mAh Lilon (English label)	SNN5730A
Andonised brown battery 740 mAh Lilon (PRC label)	SNN5732A
Switchmode charger - US plug	SPN5150A
Switchmode charger	SPN5151A
Switchmode charger - HK plug	SPN5152A
Klaus adaptor - Euro plug	SYN7456A
Klaus adaptor - Aus/NZ plug	SYN8127A
Audio & Connectivity	
One touch headset	SYN8419B
Black mono headset	SYN8390B
Silver mono headset	AAYN4264B
Cheerful pink universal FM stereo headset	CHYN4391B
Zest blue universal FM stereo headset	CHYN4392B/C
Psuedo USB data cable	CHKN4565A
Mobile phone tools CD-ROM	9988076Z02
Consumer Personalization	
Silver lanyard (rest of Asia)	AAYN4402
Silver lanyard (PRC)	CHYN4546
Silver wristyard (rest of Asia)	AAYN4403
Carrying case & lanyard	TBD

Index

A

About

Audience 4

Conventions 5

Scope 4

Accessories and Aftermarket Division 6

Audience 4

B

Battery

Disposal 16

Function 14

Operation 14

Removing and Replacing 16

Battery Gauge 14

C

Caller Line Identification 10

Controls 11

Conventions 5

Customer Support 5

D

Disassembly 15

E

Electrostatic Discharge 15

G

General Functions 11

H

Headset Connector Port 11

I

Indicators 11

Input/Output (I/O) Connectors 11

International Mobile Station Equipment Identity (IMEI) 27

Number Breakdown 27

L

Left Soft Key 11
Liquid Crystal Display (LCD) 12
Low Battery 14

M

Mechanical Serial Number 27
Menu Key 11
Menu Navigation 11
Microphone 11

N

Navigation Key 11

O

Other Features 10
Out of Box Failure Policy 5

P

Part Number Charts 32
Parts Replacement 6
 Accessories and Aftermarket Division 6
Power Connector Port 11
Power/End Key 11
Product Overview 9
 Caller Line Identification 10
 Features 9
 Other Features 10
 SIM Toolkit™ - Class 2 10
 Simplified Text Entry 10
Product Support 5

R

Right Soft Key 11

S

Scope 4
Send/Answer Key 11
SIM Card 27
 Identification Label 27
 International Mobile Station Equipment Identity (IMEI) 27
 Mechanical Serial Number 27
 Removing and Replacing 17
SIM Toolkit™ - Class 2 10
Simplified Text Entry 10
Specifications 7

T

Tools and Test Equipment 14
Troubleshooting 29

U

USB Connector Port 11
User Interface 11
User Interface Menu Structure 13

W

Warranty Service Policy 5
 Customer Support 5
 Out of Box Failure Policy 5
 Product Support 5

MOTOROLA, the Stylized M Logo, and all other trademarks indicated as such herein are trademarks of Motorola, Inc.
All other product or service names are the property of their respective owners.

® Reg. U.S. Pat. & Tm. Off.

© 2005 Motorola, Inc.

All rights reserved.

Personal Communications Sector,
Sawgrass International Concourse
789 International Parkway Room S2C
Sunrise, FL 33323