



MOTOROLA

intelligence everywhere™

Field Service Manual

Basic and Field Level Test Procedures



iDEN i730
***Digital Multi-Service,
Data-Capable Portable***



MOTOROLA
intelligence everywhere™

***i*DEN**

i730
Digital Multi-Service,
Data-Capable Portable

Field Service Manual

Basic and Field Level
Test Procedures

September 18, 2003

Manual Revisions

Changes that occur after this manual is printed are described in the Field Manual Revisions (FMRs). The FMRs provide the most current instructions and component information.

Copyright Information

The Motorola products described in this manual may include Motorola computer programs stored in semiconductor memories or other media that are copyrighted with all rights reserved worldwide to Motorola. Laws in the United States and other countries preserve for Motorola, Inc. certain exclusive rights to the copyrighted computer programs, including the exclusive right to copy, reproduce, modify, decompile, disassemble, and reverse-engineer the Motorola computer programs in any manner or form without Motorola's prior written consent. Furthermore, the purchase of Motorola products shall not be deemed to grant either directly or by implication, estoppel, or otherwise, any license or rights under the copyrights, patents, or patent applications of Motorola, except for a nonexclusive license to use the Motorola product and the Motorola computer programs with the Motorola product.

Trademarks

MOTOROLA, the Stylized M Logo, Message Mail, VibraCall, and iDEN are registered trademarks of Motorola, Inc. ® Reg. U.S. Pat. & Tm. Off. All other product or service names are the property of their respective owners.

© Copyright 2003, Motorola, Inc. All rights reserved.

SAFETY AND GENERAL INFORMATION

**IMPORTANT INFORMATION ON SAFE AND EFFICIENT OPERATION.
READ THIS INFORMATION BEFORE USING YOUR INTEGRATED
MULTI-SERVICE PORTABLE RADIO.**

RF Operational Characteristics

Your radio product contains a radio frequency transmitter to convey the information you wish to send as well as occasional automatic signals used to sustain connection to the wireless network, and a receiver which enables you to receive communication and connection information from the network.

PORTABLE RADIO PRODUCT OPERATION AND EME EXPOSURE

Your Motorola two-way radio complies with the following RF energy exposure standards and guidelines:

- United States Federal Communications Commission, Code of Federal Regulations; 47 CFR part 2 sub-part J
- American National Standards Institute (ANSI) / Institute of Electrical and Electronics Engineers (IEEE). C95. 1-1992
- Institute of Electrical and Electronics Engineers (IEEE). C95. 1-1999 Edition
- International Commission on Non-Ionizing Radiation Protection (ICNIRP) 1998
- Ministry of Health (Canada). Safety Code 6. Limits of Human Exposure to Radiofrequency Electromagnetic Fields in the Frequency Range from 3 kHz to 300 GHz, 1999
- Australian Communications Authority Radiocommunications (Electromagnetic Radiation - Human Exposure) Standard 2001
- ANATEL, Brasil Regulatory Authority, Resolution 256 (April 11, 2001) “additional requirements for SMR, cellular and PCS product certification.”

To assure optimal radio product performance and make sure human exposure to radio frequency electromagnetic energy is within the guidelines set forth in the above standards, always adhere to the following procedures:

Phone Operation

When placing or receiving a phone call, hold your radio product as you would a wireline telephone. **Speak directly into the microphone.**

Two-way radio operation

When using your radio product as a traditional two-way radio, **hold the radio product in a vertical position with the microphone one to two inches (2.5 to 5 cm) away from the lips.**



Body-worn operation

To maintain compliance with FCC RF exposure guidelines, if you wear a radio product on your body when transmitting, always place the radio product in a **Motorola approved clip, holder, holster, case or body harness for this product.** Use of non-Motorola-approved accessories may exceed FCC RF exposure guidelines. **If you do not use a Motorola approved body-worn accessory and are not using the radio product in the intended use positions along side the head in the phone mode or in front of the face in the two-way radio mode, then ensure the antenna and the radio product are kept the following minimum distances from the body when transmitting:**

- **Phone or Two-way radio mode: one inch (2.5 cm)**
- **Data operation using any data feature with or without an accessory cable: one inch (2.5 cm)**

Antenna Care

Use only the supplied or an approved replacement antenna. Unauthorized antennas, modifications, or attachments could damage the radio product and may violate FCC regulations.

DO NOT hold the antenna when the radio product is “IN USE”. Holding the antenna affects call quality and may cause the radio product to operate at a higher power level than needed.

Approved Accessories

For a list of approved Motorola accessories call 1-800-453-0920, visit our website at www.mot.com/iden or look in the accessory section of this manual.

ALL MODELS WITH FCC ID AZ489FT5824 MEET THE GOVERNMENT'S REQUIREMENTS FOR EXPOSURE TO RADIO WAVES.

Your wireless phone is a radio transmitter and receiver. It is designed and manufactured not to exceed the emission limits for exposure to radiofrequency (RF) energy set by the Federal Communications Commission of the U.S. Government. These limits are part of comprehensive guidelines and establish permitted levels of RF energy for the general population. The guidelines are based on standards that were developed by independent scientific organizations through periodic and thorough evaluation of scientific studies. The standards include a substantial safety margin designed to assure the safety of all persons, regardless of age and health.

The exposure standard for wireless mobile phones employs a unit of measurement known as the Specific Absorption Rate, or SAR. The SAR limit set by the FCC is 1.6 W/kg.* Tests for SAR are conducted using standard operating positions specified by the FCC with the phone transmitting at its highest certified power level in all tested frequency bands. Although the SAR is determined at the highest certified power level, the actual SAR level of the phone while operating can be well below the maximum value. This is because the phone is designed to operate at multiple power levels so as to use only the power required to reach the network. In general, the closer you are to a wireless base station antenna, the lower the power output.

Before a phone model is available for sale to the public, it must be tested and certified to the FCC that it does not exceed the limit established by the government-adopted requirement for safe exposure. The tests are performed in positions and locations (e.g., at the ear and worn on the body) as required by the FCC for each model. The highest SAR value for this model phone when tested for use at the ear is 1.163 W/kg and when tested on the body, as described in the user guide, is 1.15 W/kg during packet data transmission. (Body-worn measurements differ among phone models, depending upon available accessories and FCC requirements.) While there may be differences between the SAR levels or various phones and at various positions, they all meet the government requirement for safe exposure.

The FCC has granted an Equipment Authorization for this model phone with all reported SAR levels evaluated as in compliance with the FCC RF exposure guidelines. SAR information on this model phone is on file with the FCC and can be found under the Display Grant section of <http://www.fcc.gov/oet/fccid> after searching on FCC ID AZ489FT5824.

Additional information on Specific Absorption Rates (SAR) can be found on the Cellular Telecommunications Industry Association (CTIA) web-site at <http://www.wow-com.com>.

* In the United States and Canada, the SAR limit for mobile phones used by the public is 1.6 watts/kg (W/kg) averaged over one gram of tissue. The standard incorporates a substantial margin of safety to give additional protection for the public and to account for any variations in measurements.

Electro Magnetic Interference/ Compatibility

NOTE: Nearly every electronic device is susceptible to electromagnetic interference (EMI) if inadequately shielded, designed or otherwise configured for electromagnetic compatibility.

Facilities

To avoid electromagnetic interference and/or compatibility conflicts, turn off your radio product in any facility where posted notices instruct you to do so. Hospitals or health care facilities may be using equipment that is sensitive to external RF energy.

Aircraft

When instructed to do so, turn off your radio product when on board an aircraft. Any use of a radio product must be in accordance with applicable regulations per airline crew instructions.

Medical Devices

Pacemakers

The Advanced Medical Technology Association (AdvaMed) recommends that a minimum separation of 6 inches (15 cm) be maintained between a handheld wireless radio product and a pacemaker. These recommendations are consistent with those of the U.S. Food and Drug Administration.

Persons with pacemakers should:

- ALWAYS keep the radio product more than 6 inches (15 cm) from their pacemaker when the radio product is turned ON.
- Not carry the radio product in a breast pocket.
- Use the ear opposite the pacemaker to minimize the potential for interference.
- Turn the radio product OFF immediately if you have any reason to suspect that interference is taking place.

Hearing Aids

Some digital wireless radio products may interfere with some hearing aids. In the event of such interference, you may want to consult your hearing aid manufacturer to discuss alternatives.

Other Medical Devices

If you use any other personal medical device, consult the manufacturer of your device to determine if it is adequately shielded from RF energy. Your physician may be able to assist you in obtaining this information.

Use While Driving

Check the laws and regulations on the use of radio products in the area where you drive. Always obey them. When using the radio product while driving, please:

- Give full attention to driving and to the road.
- Use hands-free operation, if available.
- Pull off the road and park before making or answering a call if driving conditions so require.



Operational Warnings

For Vehicles Equipped with an Air Bag

Do not place a portable radio product in the area over the air bag or in the air bag deployment area. Air bags inflate with great force. If a portable radio is placed in the air bag deployment area and the air bag inflates, the radio product may be propelled with great force and cause serious injury to occupants of the vehicle.

Potentially Explosive Atmospheres

Turn off your radio product prior to entering any area with a potentially explosive atmosphere, unless it is a radio product type especially qualified for use in such areas as “Intrinsically Safe” (for example, Factory Mutual, CSA, or US approved). Do not remove, install, or charge batteries in such areas. Sparks in a potentially explosive atmosphere can cause an explosion or fire resulting in bodily injury or even death.

NOTE: The areas with potentially explosive atmospheres referred to above include fueling areas such as below decks on boats; fuel or chemical transfer or storage facilities; areas where the air contains chemicals or particles, such as grain, dust or metal powders; and any other area where you would normally be advised to turn off your vehicle engine. Areas with potentially explosive atmospheres are often, but not always, posted.

Blasting Caps and Areas

To avoid possible interference with blasting operations, turn off your radio product when you are near electrical blasting caps, in a blasting area, or in areas posted: “Turn off two-way radio”. Obey all signs and instructions.

Cleaning and Drying Considerations

Using a leather carry case may help protect the surfaces and help prevent liquids (e.g., rain) from entering into the interior of the radio product. This product is not water proof, and exposing the unit to liquids may result in permanent damage to the unit.

If your radio product interior gets wet, then do not try to accelerate drying with the use of an oven or a dryer as this will damage the radio product and void the warranty. Instead, do the following:

1. Immediately power off the radio product.
2. Remove Battery and SIM card (if so equipped) from radio product.
3. Shake excess liquid from radio product.
4. Place the radio product and battery in an area that is at room temperature and has good air flow.
5. Let the radio product, battery, and SIM card dry for 72 hours before reconnecting the battery and/or powering on the radio product.



Operational Cautions

Antennas

Do not use any portable radio product that has a damaged antenna. If a damaged antenna comes into contact with your skin, a minor burn can result.

Batteries

All batteries can cause property damage and/or bodily injury, such as burns if a conductive material, such as jewelry, keys, or beaded chains touches exposed terminals. The conductive material may complete an electrical circuit (short circuit) and become quite hot. Exercise care in handling any charged battery, particularly when placing it inside a pocket, purse, or other container with metal objects.

If the radio product does not work after following the steps listed above, contact your dealer for servicing information.

Clean the external surfaces of the radio product with a damp cloth, using a mild solution of dishwashing detergent and water. Some household cleaners may contain chemicals that could seriously damage the radio product. Avoid the use of any petroleum-based solvent cleaners. Also, avoid applying liquids directly on the radio product.

Accessory Safety Information

IMPORTANT: SAVE THESE ACCESSORY SAFETY INSTRUCTIONS

- Before using any battery or battery charger, read all the instructions for and cautionary markings on (1) the battery, (2) the battery charger, which may include a separate wall-mounted power supply or transformer, and (3) the radio product using the battery.
- Do not expose any battery charger to water, rain, or snow as they are designed for indoor or in-vehicle use only.



WARNING: To reduce the risk of injury, charge only the rechargeable batteries listed in the Accessories section of this manual. Other types of batteries may burst, causing personal injury and damage.

- To reduce the risk of damage to the cord or plug, pull by the plug rather than the cord when you disconnect the battery charger from the power source outlet.
- Do not operate any battery charger with a damaged cord or plug — replace them immediately.
- Battery chargers may become warm during operation, but not hot. If it becomes hot to the touch, unplug it from the power outlet immediately and discontinue its use.

SAFETY AND GENERAL INFORMATION

- Use of a non-recommended attachment to a battery charger may result in a risk of fire, electric shock, or injury to persons.
- Make sure the battery charger power cord is located so that it will not be stepped on, tripped over, or subjected to damage or stress.
- An extension cord should not be used with any battery charger unless absolutely necessary. Use of an improper extension cord could result in a risk of fire and electric shock. If an extension cord must be used, make sure that:
 - The pins on the plug of the extension cord are the same number, size, and shape as those on the plug of the charger.
 - The extension cord is properly wired and in good electrical condition.
 - The cord size is 18AWG for lengths up to 100 feet and 16AWG for lengths up to 150 feet.
- Do not operate any battery charger if it has received a sharp blow, has been dropped, or has been damaged in any way; take it to a qualified service technician.
- Do not disassemble a battery charger; take it to a qualified service technician when service or repair is required. Incorrect reassembly may result in a risk of electric shock or fire.
- Maximum ambient temperature around the power supply or transformer of any battery charger should not exceed 40°C (104°F).
- The output power from the power supply or transformer must not exceed the rating given on the Desktop Dual-Pocket Charger.
- The disconnection from the line voltage is made by unplugging the power supply from the AC receptacle.
- To reduce risk of electric shock, unplug any battery charger from the outlet before attempting any maintenance or cleaning.

For optimum charging performance, turn off the radio product while charging it in any battery charger.

MODEL INFORMATION

This manual applies to the following *iDEN i730* Digital Portable models:

H63XAN6RR4AN 806-940 MHz, Multi-Service, Data-Capable Portable

MODEL NUMBERING SYSTEM

Typical Model Number: H 6 3 X A N 6 R R 4 A N
Position: 1 2 3 4 5 6 7 8 9 10 11 12

Position 1 - Type of Unit

H = Hand-Held Portable
M = Mobile Product

Positions 2 and 3 - Model Series

02 = Motorola Digital Communicator
06 = Motorola Advanced Feature Digital
07 = Motorola i370 Products
08 = Motorola i1000 Products
12 = Motorola 3:1 Mobile
13 = Motorola Ruggedized Digital
15 = Motorola i600 Products
26 = Motorola i1000plus Products
27 = Motorola i500plus Products
29 = Motorola i700plus Products
32 = Motorola i2000plus Products
35 = Motorola i2000 Products
36 = Motorola i550plus Products
40 = Motorola i85s/i55sr/i50sx Products
41 = Motorola i90c Products
48 = Motorola i80s Products
58 = Motorola i88s/i58sr Products
62 = Motorola i205/i305 Products
63 = Motorola i730 Products

Position 4 - Frequency Band

U = 806 to 870 MHz
X = 806 to 941 MHz
*Values given represent range only; they are not absolute.

Position 5 - Power Level

A = 0 to 0.7 Watts
B = 0.7 to 0.9 Watts
C = 1.0 to 3.9 Watts
D = 4.0 to 5.0 Watts
E = 5.1 to 6.0 Watts
F = 6.1 to 10.0 Watts

Position 6 - Physical Packages

F = Limited Keypad - With Display
H = Full Keypad - With Display
N = Enhanced Controls - Enhanced Display

Position 7 - Channel Spacing

1 = 5 kHz 5 = 15 kHz
2 = 6.25 kHz 6 = 25 kHz
3 = 10 kHz 7 = 30 kHz
4 = 12.5 kHz 9 = Variable Programmable

Position 8 - Primary Operation

N = Digital Dispatch
Q = Low Profile - Basic Display
R = Digital Multi-Service
J = TDMA Digital Dual Mode

Position 11 - Version

Version Letter (Alpha) -
Major Change

Position 10 - Feature level

1 = Basic 6 = Standard Plus
2 = Limited Pkg 7 = Expanded Pkg
3 = Limited Plus 8 = Expanded Plus
4 = Intermediate 9 = Full Feature/
5 = Standard Pkg Programmable

Position 9 - Primary System Type

R = iDEN Shared

Position 12 - Unique

Model Variations
N = Standard Package

MODEL SPECIFICATIONS

GENERAL		RECEIVER		TRANSMITTER	
FCC Designation:	AZ489FT5824	Receiver Type:	Superheterodyne	Transmitter Type:	Single Conversion
Operational Modes:	Phone Private Group Circuit Data Packet Data	Frequency Range:	851-870 MHz 935-940 MHz	Frequency Range:	806-825 MHz 896-901 MHz
800 MHz Band only:		Channel Spacing:	25 kHz	Emission Designator:	18K3D7W
Temperature Range:		Frequency Stability:		Modulation Types:	Quad 16QAM Quad 64QAM Quad QPSK
Operating	-10°C to +60°C	Referenced to base station	0.4 ppm	Frequency Stability:	
Storage (w/o battery)	-40°C to +85°C	Sensitivity (10%)BER:		Referenced to base station	0.4 ppm
Power Supply:		(M-16 QAM)	-111 dBm	Spurious Emissions:	
Battery Type	Lithium Ion	Spurious Response Immunity:	-51 dBm	Conducted	-13 dBm
Recommended Battery:	SNN5704 SNN5705	Spurious Radiation:		Radiated	-13 dBm
Battery Voltage:		Above 960 MHz	<500 µV/m.	RF Pulse Avg Power:	
Nominal	3.6 Vdc	216-960 MHz	<200 µV/m.	(dynamically adjusted)	-11 to +28 dBm
Range	3.0 to 4.2 Vdc	88-216 MHz	<150 µV/m.	Adjacent Channel Power:	
Dimensions (HxWxD):		30-88 MHz	<100 µV/m.	(at ±25 kHz in 18 kHz BW)	-55 dB
Phone only	93 x 25 x 52 mm	Audio Output Power and Speakerphone Rating:			
Weight:		(Private and Group Modes only) into 8 ohms at maximum volume (nominal battery voltage)	500 mW		
(without battery)	122 g	Distortion at Rated Audio:			
		Electrical	5% Max.		
		Acoustical	10% Max.		

Specifications subject to change without notice.

CONTENTS

	SAFETY AND GENERAL INFORMATION	iii
	MODEL INFORMATION	vii
	MODEL SPECIFICATIONS	viii
	CONTENTS	ix
	PREFACE	xiii
	Who Should Use This Manual	xiii
	How This Manual Is Organized	xiii
	Conventions Used in This Manual	xiv
	Related Publications	xiv
CHAPTER 1	OVERVIEW	1-1
	<i>i</i> DEN Digital Modulation Technology	1-1
	<i>i</i> DEN Voice Compression Technology	1-3
	RF Transmission Burst	1-3
	Calling Area Coverage	1-4
	Global Positioning System (GPS) Section	1-5
	SIM Cards	1-5
	Removing and Inserting a SIM Card	1-5
CHAPTER 2	COMPONENTS, ICONS, AND INDICATORS	2-1
	<i>i</i> 730 Component Views	2-1
	Display Icons	2-2
	Main Menu Icons	2-2
	Status Icons	2-3
	Call Icons	2-4
	Contacts Type Icon	2-6
	Outbox Icons	2-6
CHAPTER 3	DISPLAYS, MESSAGES, AND ALERTS	3-1
	Power-Up Sequence	3-1
	Power-Down Sequence	3-2

Messages	3-2
Self-Test Errors	3-2
Self-Test Reset Errors	3-2
Service Messages	3-3
Alert Tones	3-4
Using the Optional Vibrate Function	3-7

CHAPTER 4 PREPARING FOR BASIC LEVEL TESTING 4-1

Removing the Antenna Assembly	4-1
Installing the Antenna Assembly	4-2
Additional Test Equipment	4-2
Reference Unit	4-3
Reference Accessories	4-3

CHAPTER 5 BASIC LEVEL CHECKS AND SELF TESTS 5-1

Customer Care	5-1
Test Conditions	5-1
Antenna Condition	5-1
Reset Condition	5-1
Basic-Level Test Checklist	5-2
Preventive Maintenance	5-2
Mechanical and Electrical Checks	5-3
Shock and Pressure Test	5-3
SIM Card Swap Test	5-3
Accessory Swap Test	5-4
Lockup Test	5-4
Battery Connections Test	5-5
Testing the GPS Receiver	5-5
Voltage Recognition Test	5-6
Troubleshooting	5-7
Self-Test Procedures	5-7
Passcode Test	5-7
Programming Menu Settings Check	5-7
Call Performance Test	5-12

**CHAPTER 6 BASIC LEVEL TEST MODES
AND PROCEDURES 6-1**

Test Modes	6-1
Entering Debug Mode	6-1
Display Screens	6-2
Entering Test Mode	6-3
Test Mode Test Procedures	6-4
Audio Loopback Test	6-4
ESN and IMEI Matching Test	6-5
Engineering Debug Check	6-5

	Technician Test Procedures	6-8
	Programming the <i>i730</i> Unit	6-8
	Connecting the Unit to the RSS Workstation	6-8
	Codeplug Repair Procedure	6-9
	Codeplug Troubleshooting	6-10
	Corrupted Software Repair Procedure	6-10
CHAPTER 7	PREPARING FOR FIELD LEVEL TESTING	7-1
	Preparing Equipment for Testing	7-1
	Calibrating Equipment	7-1
	Checking the RF Cable	7-1
	Strong-Signal Environments	7-1
	Protecting Static-Sensitive Devices	7-1
	Using RSS	7-2
	Connecting an <i>i730</i> Unit to the R-2660	7-3
	Operating the R-2660	7-4
	Disassembling and Reassembling the <i>i730</i> Unit	7-5
	Disassembly Sequence Flowchart	7-6
	Disassembly Procedure	7-7
	Removing the Antenna	7-7
	Removing the Back Housing	7-7
	Removing the Display/Mute Keypad, PTT-Volume Keypad, and Audio Jack Seal	7-8
	Removing the Main Keypad	7-9
	Removing the Flip Assembly	7-9
	Removing the Coin Cell	7-11
	Removing the Microphone	7-11
	Assembly Procedures	7-12
	Installing the Microphone	7-12
	Installing the Flip Assembly	7-12
	Installing the Main Keypad	7-13
	Installing the Top Button and Audio Jack Seal	7-14
	Installing the Coin Cell	7-15
	Installing the Main and Controller Keyboards	7-15
	Installing the PTT/Volume Keypad	7-16
	Attaching the Back Cover	7-17
	Exploded Views and Parts Lists	7-18
	<i>i730</i> Unit - Exploded View	7-19
CHAPTER 8	FIELD LEVEL TEST MODES AND PROCEDURES	8-1
	Required Test Equipment	8-1
	Test Modes	8-1
	Entering Test Mode	8-1
	Field-Level Test Checklist	8-2
	Registration/Call Test	8-4
	SQE Test	8-5

TX Power Test	8-6
RX BER Test	8-7
Power-Up Test	8-8
Keypad Test	8-9
Audio Test	8-10
Reset Test	8-11
Reset Log Test	8-12
Model Assembly (MA) Test Mode Test	8-13
GPS Receiver	8-18

APPENDIX A

ORDERING REPLACEMENT PARTS AND KITS	A-1
Replacement Parts	A-1
 GLOSSARY	 G-1
 INDEX	 I-1

PREFACE

The *iDEN i730 Digital Multi-Service, Data-Capable Portable Field Service Manual* contains the information necessary to identify and fix problems in the Motorola *i730* Digital Portable. This unit is based on digital technology and is designed to operate on *iDEN* systems.

Basic and field-level service for the *i730* unit as described in this manual includes troubleshooting, testing, board swapping, and maintenance.

Service for the *i730* unit is based on the substitution method: a faulty part is replaced by a working one, providing quicker service to the customer. For example, if the battery is faulty, it is replaced. If the unit requires more complete testing or service than is available at the basic level, it is sent to the field-level service facility, serviced, and returned to the *iDEN* Customer Care Center (ICC).

NOTE: Before operating or testing this unit, please read the **Safety and General Information** section in the front of this manual.

1.1 Who Should Use This Manual

This manual is intended for service technicians who should be familiar with the test equipment recommended in Appendix A. To help pinpoint basic problems with the unit, first perform the mechanical checks and self tests as described in Chapter 5; then proceed to field level troubleshooting and testing.

1.2 How This Manual Is Organized

This manual contains the following chapters and appendices:

Chapter 1 presents the theory and technology used by the *iDEN* system and the *i730* unit.

Chapter 2 describes the *i730* components, icons, and indicators.

Chapter 3 describes displays, messages, and alerts.

Chapter 4 describes preparing for basic level testing.

Chapter 5 describes basic mechanical checks and self test procedures to be performed.

Chapter 6 describes basic test modes and technician test procedures.

Chapter 7 describes how to prepare and operate field level test equipment. It also contains disassembly and reassembly instructions.

Chapter 8 describes field level test modes and procedures.

Appendix A provides information on ordering kits and replacement parts. It also contains lists of recommended test equipment.

Glossary contains a listing of terms, acronyms, and definitions that apply to the *iDEN* system.

1.3 Conventions Used in This Manual

The following conventions are used throughout this manual:

<i>italics</i>	Used for emphasis and new terms
bold	Defines menu items, fields, and buttons
code	Used for sample input and output

1.4 Related Publications

The following publications are available separately:

<i>iDEN i730 Digital Multi-Service Data-Capable Phone User's Guide</i>	NNTN4760A
<i>iDEN Companion Pro User's Guide</i>	NTN1755
<i>iDEN Customer Care Troubleshooting Guide</i>	68P81082C56
<i>R-2660 Digital Communications System Analyzer Operator's Manual</i>	68P80386B72
<i>Radio Service Software User's Guide</i>	68P02936C85*
<i>Rapid Charger User's Guide</i>	68P81084C33
<i>Wireless Data Services User's Guide</i>	NTN9118A

*This publication available online at: <http://businessonline.motorola.com> as part of the RSS application download package. Also available on the RSS application CD through Motorola's Aftermarket & Accessories Division, 1-800-422-8210.

CHAPTER 1

OVERVIEW

To achieve a high spectrum efficiency, the *i730* digital multi-service, data-capable portable uses a unique modulation technology and sophisticated voice-compression algorithm. The voice of the person speaking into the microphone is converted into a digital bit stream consisting of zeros (0) and ones (1). The stream then is modulated into a radio-frequency (RF) signal, which is transmitted over the air to another unit. This process is called *digital modulation*.

1.1 *i*DEN Digital Modulation Technology

The *i730* digital portable is a dual band 806-870 MHz and 896-940 MHz unit that can operate in multiple modes: *phone*, *private*, *data*, and *group*. It uses three digital modulation technologies: Quad QAM, Quadrature Phase Shift Keying (QPSK), and Time Division Multiple Access (TDMA).

Quadrature Amplitude Modulation (QAM) is a modulation technique that transmits information by altering the amplitude and phase of the radio frequency (RF) signal. Data is converted into complex symbols, which alter the RF signal and transmit the information. When the signal is received, the amplitude and phase are converted back into symbols and then into the original data.

There are three different QAM modes that are used for different applications: *64QAM*, *16QAM*, and *4QAM*. In voice applications, *16QAM* is used, while in data applications, *64QAM*, *16QAM*, and *4QAM* are used.

NOTE: The 900 MHz band operates only in *16QAM* modulation.

In *64QAM*, 64 possible combinations of 6 bits are converted into a unique amplitude and phase. In *16QAM*, there are 16 possible combinations of 4 bits, while in *4QAM*, there are 4 possible combinations of 2 bits.

The traditional 25 kHz channel used for two-way radios is split into four QAM signals (subcarriers) that are transmitted simultaneously. This technique can transmit 64 Kbps in a single 25 kHz channel.

The *iDEN* system requires approximately 10 Kbps to transmit a compressed voice; therefore, 64 Kbps can accommodate 6 voice channels or 3 voice channels in enhanced systems.

The signal spectrum of the Quad *16QAM* is shown in Figure 1-1.

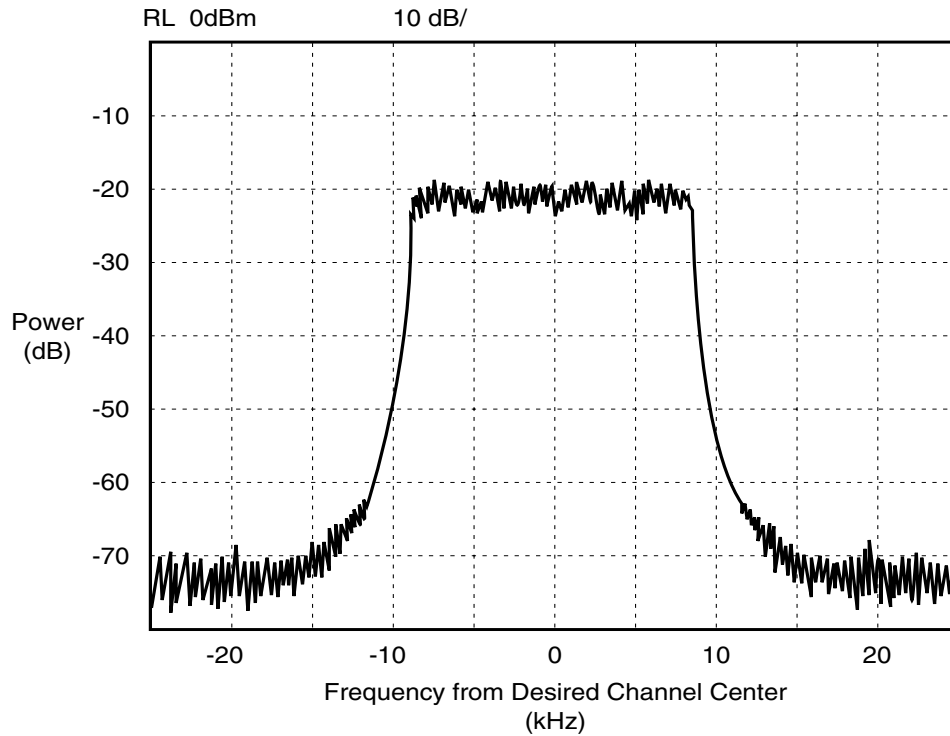

Figure 1-1. Spectrum of iDEN Quad 16QAM

Quadrature Phase Shift Keying (QPSK) is one of the most common modulation techniques for satellite communications. In QPSK, a digital data stream is taken two bits at a time to generate four possible phase states of the transmitted carrier. A characteristic of this technique is its resistance to noise.

Time Division Multiple Access (TDMA) is used to allocate portions of the RF signal by dividing time into 6 slots, one for each unit. Time allocation enables each unit to transmit its voice information without interference from another unit's transmission.

Transmission from a unit or base station is accommodated in time-slot lengths of 15 milliseconds and frame lengths of 90 milliseconds (see Figure 1-2).

Note that **Rx** (outbound) indicates base-to subscriber transmissions; **Tx** (inbound) indicates subscriber-to-base transmissions. The slots are paired and have a fixed offset of 19 milliseconds; their timings are synchronized by the iDEN system. The TDMA technique requires sophisticated

algorithms and one digital-signal processor (DSP) to perform voice compression/decompression and RF modulation/demodulation.

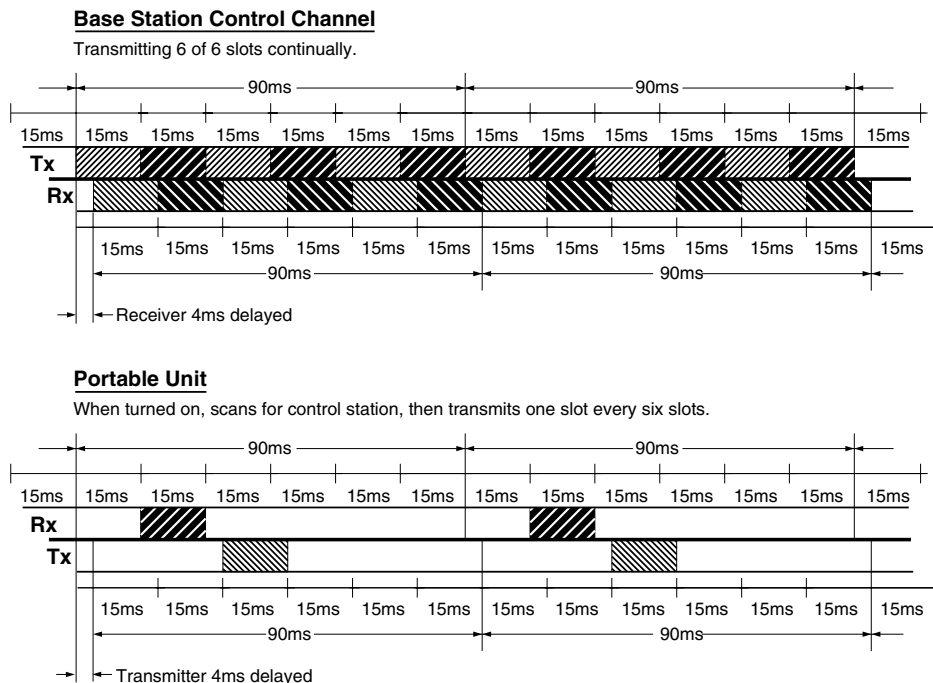

Figure 1-2. iDEN TDMA Format

1.2 iDEN Voice Compression Technology

Voice is converted into a digital bit stream by sampling the voice signal at a high rate and converting the samples into numbers, which are represented by bits. A sample consists of 8 bits. Approximately 8000 samples per second (64 Kbps) are required to maintain a reasonable quality.

Voice compression reduces the number of bits per second while maintaining the voice at an acceptable quality level. The iDEN system uses a coding technique called *Vector Sum Excited Linear Prediction (VSELP)* to compress voice to 4.2 or 8.0 Kbps. The compressed voice-data bits modulate the RF signal. The compression rate is based on the type of call (dispatch or interconnect) and the network configuration established by the local service provider.

Adding error-correction bits to the coded-voice bits increases the required RF-transmission bit rate to approximately 7.4 Kbps for the 4.2 Kbps voice coder and 14.8 Kbps for the 8.0 Kbps voice coder.

1.2.1 RF Transmission Bursts

All RF transmissions within an iDEN system occur in 15-millisecond blocks called *bursts*. An iDEN base station transmits bursts continually on each RF frequency it uses. Transmission bursts from the stations are synchronized in time by signals received from the global positioning satellite

(GPS) system. Each burst is numbered; the number is referred to as the *slot* number. All bursts occurring at a given time carry the same slot number.

Inbound transmission bursts (sent from the unit) are offset 19 milliseconds from the outbound burst; the inbound burst begins 4 milliseconds after the end of the outbound burst (see Figure 1-2 on page 1-3). This offset in time allows the unit to appear capable of transmitting and receiving at the same time (it actually is switching rapidly back and forth between receiving and transmitting).

In current iDEN systems, outbound transmissions in the 800 MHz band range from 851–870 MHz; inbound transmissions are 45 MHz lower in frequency. For the 900 MHz band, outbound transmissions range from 935-940 MHz; inbound transmissions are 39 MHz lower in frequency.

An iDEN channel is created by grouping bursts so that their slot numbers differ by a number referred to as the *repetition rate*. The i730 units use two repetition rates for interconnect voice calls: 6:1 and 3:1. A single frequency can handle 6 calls using a 6:1 repetition rate with the 4.2 Kbps coder.

Dispatch calls always use this rate. However, the audio quality of the 3:1 repetition rate with the 8.0 Kbps coder is superior to the 6:1 rate with the 4.2 Kbps coder. Most service providers configure the system and unit to allow only the 3:1 rate for interconnect calls.

Calls are set up on a primary control channel (PCCH) in response to a request from a unit or a regular telephone connected to the Public Switch Telephone Network (PSTN). The PCCH is established by the base station equipment; typically, it is a 6:1 channel.

The outbound PCCH carries system information and “pages” to specific subscriber units and asks them to respond if they are available for a call. Inbound PCCH transmissions carry responses to the “pages” and requests by subscriber units to set up calls. Inbound transmissions on the primary control channel only take 7.5 milliseconds and can be timed to occur in either half of a 15-millisecond burst.

The dual band unit will power up in the 800 MHz band and will use these channels for control channels—Primary Control Channel (PCCH) and Broadcast Control Channel (BCCH). The 900 MHz mode will be used only during 3:1 interconnect calls. Every attempt will be made to assign the unit to 900 MHz carriers during new 3:1 interconnect calls, handovers into a cell, and inter-cell handovers. If no resources are available, or if available resources have insufficient channel quality (in the case of a handover), then 800 MHz carriers will be evaluated.

Using the above techniques, the iDEN system can operate 6 voice channels simultaneously in dispatch mode or 3 voice channels simultaneously in interconnect mode on a single RF carrier at 25 kHz bandwidth.

1.2.2 Calling Area Coverage

Area coverage is obtained by dividing the area into a mosaic of cells. Coverage is controlled so that frequencies can be reused with less distance between sites. Each cell is covered by a base station, which is classified as *Omni* or *Sectored*. An Omni station connects base transceivers to antennas that have a circular pattern centered at the site. A Sectored station connects base transceivers to directional antennas that point in particular directions. Units that operate in a multi-site system must be able to “handoff” from one coverage area to another as the user moves about during a call. Handoff is controlled by the iDEN system.

1.3 Global Positioning System (GPS) Section

The U.S. Department of Defense (DoD) has built a 24-satellite constellation for the purpose of pinpointing locations anywhere on the planet. The satellites circle the earth every 12 hours, transmitting radio signals at a fixed frequency of 1575.42 MHz. The satellites share the 1575.42 MHz spectrum with each other through the use of CDMA modulation.

To determine a location on earth, a receiver must be built that can receive the simultaneous signals from the satellites that are in view of the receiver and use that information to calculate the location of the receiver. The receiver must pick up the signals from 4 satellites. Once the 4 satellites are located, the receiver measures the time it took for the satellite signals to arrive. From this timing information, the distance between the receiver and each satellite can be calculated. The four satellites' ephemeris data provide the satellite's X, Y, and Z positions. The range, R, is the receiver measurement made by calculating the time it took for the signal to reach the receiver. The user's position, (Ux, Uy, Uz), and the clock bias, Cb, is then calculated.

To use the GPS, a receiver that can receive the spread-spectrum signals must be built. The detected signals are then converted from RF signals into appropriate digital input formats. These digital inputs are processed and converted into position information. Once the position coordinates are determined, they are communicated to the handset microprocessor and displayed on the screen or transmitted to the base station as required.

1.4 SIM Cards

The *i730* unit is designed to work with a mini Subscriber Identity Module (SIM). The SIM card contains all of the personal data required to access *iDEN* services. Data held by the SIM card includes:

- Temporary Mobile Subscriber Identity
- Services to which the user subscribes
- PIN and unblocking codes
- Call barring codes

The SIM card is also capable of storing phone numbers and names. Available SIM cards for the *i730* are 64 kB and prepaid.

1.4.1 Removing and Inserting a SIM Card

NOTE: When a SIM card is defective and must be replaced with a new one, the following information will be erased:

- The recent calls list
- Call forwarding settings
- Net alerts
- Mobile originated text messages, drafts, and quick notes
- Information stored in Memo
- 3 most recent GPS enabled locations

- Voice records
- Voice names

To remove a SIM card (Figure 1-3):



CAUTION: Do not touch the gold-colored area of the SIM card.

1. Power off the unit and remove the battery cover and battery.
2. Turn the unit face down so that the antenna is at the upper left corner.
3. Slide the SIM card out of the SIM card holder.
4. Grasp SIM card from side of unit and pull out.

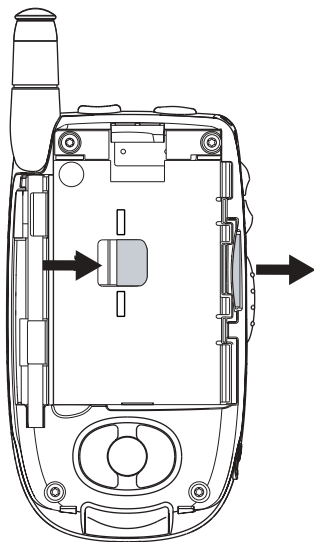

Figure 1-3. Removing a SIM Card

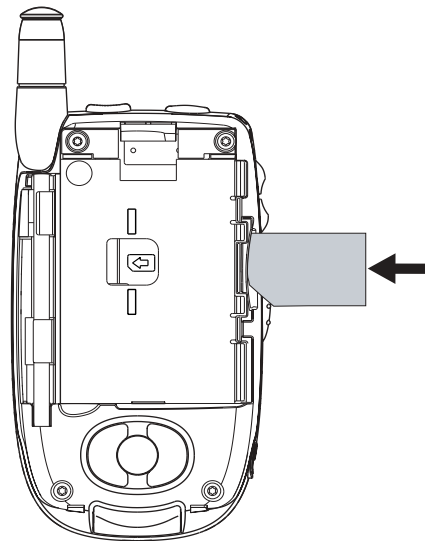

Figure 1-4. Inserting a SIM Card

To insert a SIM card (Figure 1-4):

1. Position the cut corner of the SIM card in the card holder as illustrated.
2. Carefully slide the SIM card into the unit until the card aligns with the vertical lines on either side of the SIM card opening.
3. Reinstall the battery, and reattach the battery cover.

CHAPTER 2

COMPONENTS, ICONS, AND INDICATORS

To conduct basic troubleshooting and maintenance of the *i730* unit, you must become familiar with the components, display icons, and status indicators associated with the unit.

2.1 *i730* Component Views

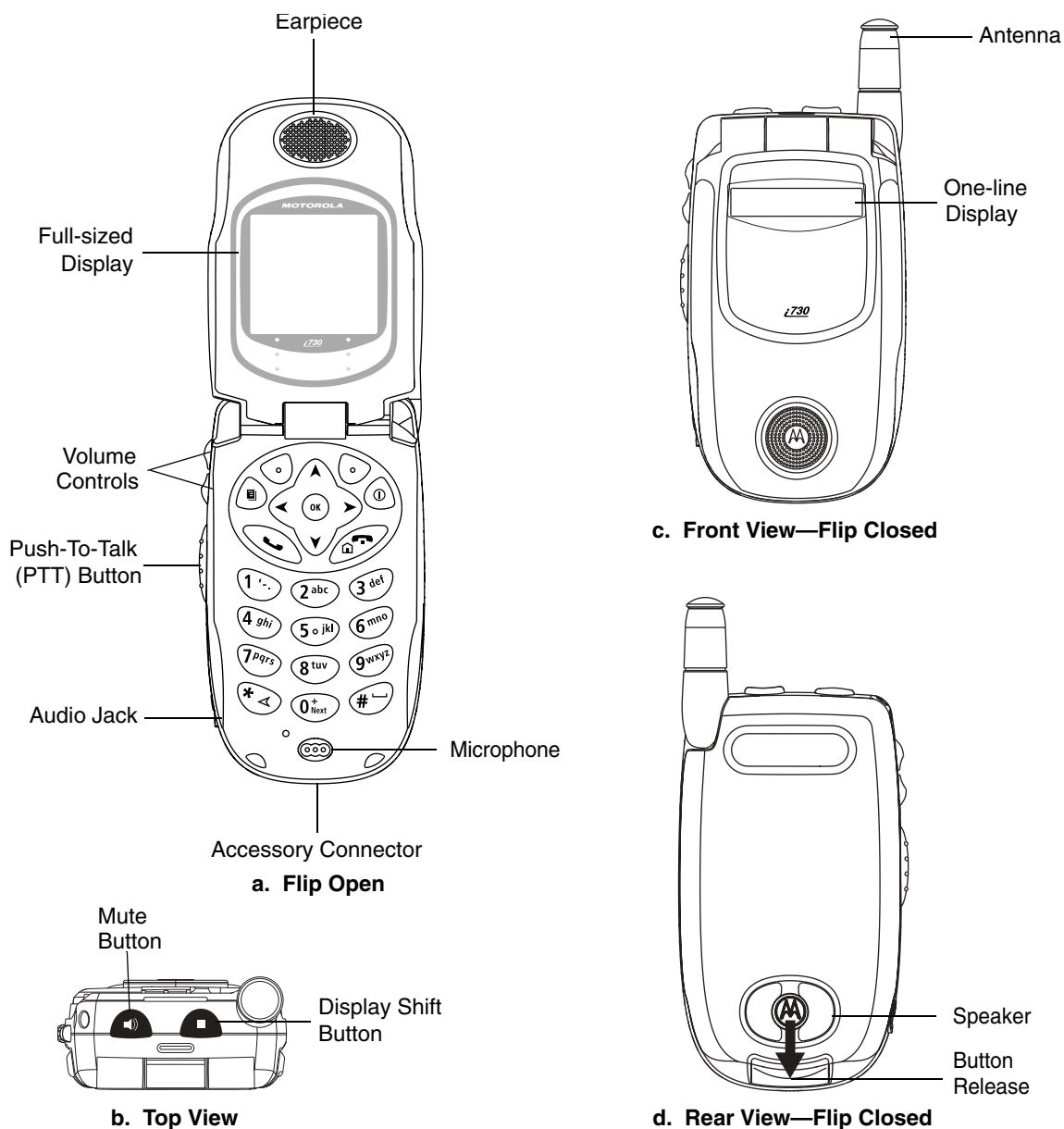



















Figure 2-1. *i730* Component Views

2.2 Display Icons

Icons for the *i730* unit provide information that is useful for troubleshooting and testing purposes. All features of the *i730* can be accessed through the main menu. When using a feature, the icon for that feature appears in the upper left corner of the display. Depending upon features and options chosen, the following icons can appear on the *i730* display.

2.2.1 Main Menu Icons

	Net	Browse the Web.
	Java Apps	Use Java applications on your phone.
	Settings: Display/Info Phone Calls DC/GC Options Volume Security Advanced	Customize your phone.
	Ring Tones: VibeAll list of ring tones Ring Tones menu	Assign ring tones and turn ringer off.
	VoiceRecord	Record and play audio messages.
	My Info	View personal phone information, including phone number and Direct Connect number.
	GPS	Find your approximate geographical location.
	Contacts: new contact form list of contacts Contacts menu	View, store, edit contacts.
	Messages: Voice Mail Net Alert Text Msgs	Access messages.
	Call Forward	Set call forwarding options.

	Datebook: new event form list of events Datebook menu	Schedule appointments.
	Memo	Store a number to access later.
	Call Timers	Phone usage information.
	Recent Calls: list of calls recent calls menu Call Setup menu	Lists recent calls.
	Shortcuts	Create shortcuts to screens.
	Profiles: new profile form list of profiles Profiles menu	Groups of settings you apply together.
	Call Alert: list of call alerts Call Alerts menu	Lists call alerts.

2.2.2 Status Icons

Status icons appear in the two rows at the top of the display. Some appear at all times. Others appear only when your phone is engaged in certain activities or when you have activated certain features.

 **Battery Strength**—Indicates that the battery is charging. Three bars indicates that the battery has been fully charged; two bars, not flashing: 2/3 charged; one bar, flashing: 1/3 charged; no bars: the battery needs to be charged.

 **Signal Strength**—Indicates the device is registered and the strength of the network signal. The antenna portion of the icon is always displayed. Up to 4 bars are displayed next to the antenna. The more bars depicted, the stronger the signal. One bar = approx. 19 SQE and >-103 RSSI, 4 bars = approx. 29 SQE and >-88 RSSI. When the unit is in a no-service state, or the signal is less than 19 SQE or <-103 RSSI, no bars appear next to the antenna.

 **Phone In Use** — your phone is active on a phone call.

 **Direct Connect In Use** — your phone is active on a Direct Connect call.

 **Talkgroup In Use** — your phone is active on a Group Connect call.

 **Active Phone Line** — 1 indicates phone line 1 is ready to make calls; 2 indicates phone line 2 is ready to make calls.

- 

Call Forward — your phone is set to forward calls.
- 

Ringer Off — your phone is set not to ring.
- 

Speaker Off — Sets Direct Connect and Group Connect sound to come through the earpiece rather than through the speaker. Your phone does not ring for DC and GC calls if Alert Type is set to SILENT or Vibrate.
- 

Messages — you have one or more messages.
- 

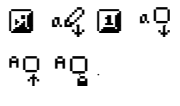
Internet — you are ready to browse the internet or are browsing the internet.
- 

T9 Text Input — you are using T9 Text Input to enter text.
- 

Airplane Mode — your phone is set to airplane mode.
- 

Packet Data — you are ready to transfer packet data or are transferring packet-data using a data cable.
- 

TTY— Indicates that unit is connected to a TTY device and TTY mode is enabled. You can select either VCO (voice-carry-over) or HCO (hearing-carry-over) mode.

2.2.3 Call Icons

When you make a call, call icons appear in text area of the phone's display.

- 

Placing a phone call.
- 

Receiving a phone call.
- 

Phone call is active.
- 











Phone call is on hold.
- 

Phone call ended.
- 

Missed phone call.

2.2.4 Contacts Type Icons

Contacts stores up to 600 numbers or addresses. Each Contacts entry can store several numbers or addresses. Information stored in Contacts is saved on your SIM card. If you move your SIM card to another SIM-based Motorola phone, you can access information stored in Contacts from that phone. Each number or address stored must be assigned a Contacts type. Contacts type icons that appear on the display are as follows:

	Mobile	phone number
	Direct Connect #	Direct Connect number
	Work1	phone number
	Work2	phone number
	Home	phone number
	email	email address
	Fax	phone number
	Pager	phone number
	Talkgroup	Talkgroup number
	IP	IP address
	Other	phone number

2.2.5 Outbox Icons

Messages you have sent are stored in the outbox. These icons appear next to messages in the outbox:

	Sent and confirmed.
	Send attempted.
	Forwarded.
	Received by addressee.
	Not received by addressee.
	Send failed.
	Re-sent.
	Locked.

This page intentionally left blank.

CHAPTER 3

DISPLAYS, MESSAGES, AND ALERTS

To conduct basic troubleshooting and maintenance of the *i730* unit, you must become familiar with the display screens, errors, messages, and alert tones associated with the unit.

3.1 Power-Up Sequence

Extend the antenna for optimum power and press \odot momentarily to turn on the unit and begin the power-up sequence. The power-up sequence initiates a series of displays on the unit. As shown below, each display reflects a stage of the sequence. If the last display shows the idle screen, the power up was successful; if the last display shows *No Service*, the unit is out of range or there is a hardware or software problem.

If the vibrate function is enabled for incoming phone calls, voice mail, or message mail, the power-up sequence includes a 500 ms. vibrate cycle.

1. Power-Up Display



Note: After Powering On the carrier logo will appear and next the T9 text input logo.

2. No SIM Display



-OR-

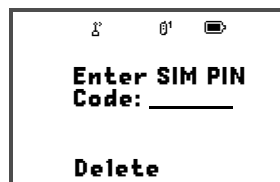

Note: SIM pin code can be cancelled in programming menu, see page 5-8.

3. Connecting Display



4. No Service Display



5. Phone Ready Display (Idle Screen)

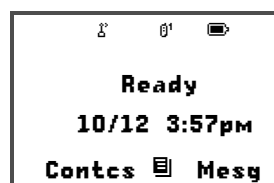

Note: Text that appears on Idle screen depends on carrier.

Figure 3-1. Power-Up Sequence Displays

3.2 Power-Down Sequence

To power down the unit, press  for one second or more.

3.3 Messages

3.3.1 Self-Test Errors

The following table contains the list of self-test non-reset errors. These errors are displayed as SELF CHECK ERROR YXXXX (YXXXX represents the identifier for that error).

Table 3-1. Self-Test Errors

Y	XXXX	Description of Error
0	0001	Non-reset error log
0	0002	Codeplug error log

3.3.2 Self-Test Reset Errors

The following table contains the list of self-test reset errors. These errors are displayed as SELF CHECK FAIL YXXXX (YXXXX represents the identifier for that error).

Table 3-2. Self-Test Reset Errors

Y	XXXX	Description of Error
0	0100	RAM failure
0	0200	Data lines failure
0	0400	Address line failure
0	0800	Codeplug corruption/invalid
0	1000	Flash checksum error
0	2000	Reset error logging
0	4000	Codeplug mismatch
F	4000	Ergo pre-self-test codeplug error
F	8000	Ergo pre-self-test invalid device or device failure
F	8002	Ergo pre-self-test invalid device or device failure
:	0800	FDI-related error

3.3.3 Service Messages

Service messages indicate the probable cause of a problem. The following table lists the messages, their probable causes, and recommended corrective actions.

Table 3-3. Service Messages

Message	Cause	Action
Charger Attached	While Power Down	
Device Attached	17-Pin connector plugged in while powered up.	
Device Detached	17-Pin connector removed while powered up.	
Device Not Compatible	Incompatible with unit's hardware	Acquire compatible software or hardware
Error	Unidentified error	Report problem to your service provider
Invalid Number	Invalid number entered or invalid voice-mail access number received	Re-enter number or report problem to service provider
Low Battery Unable to Locate Sats	Battery level is too low to obtain fix but is able to perform dispatch or interconnect communication	Charge or replace battery
No Entry	No numbers in phone list	Add phone numbers to list
No Service	Phone unable to register	Report problem to service provider
Number Not In Service	Invalid target ID	Re-enter ID or try a different ID
Please Try Again	1. Loss of service or system failure 2. Network problem	1. Ask provider how long problem will continue 2. Report problem to service provider
Service Conflict	Current service conflicts with previously activated service	Deactivate previous service and try current service again
Service Not Available	Not currently available on system	Ask provider when service will be available
Service Restricted	Service not subscribed to	Ask provider when service will be available
System Busy, Try Later	System is currently busy	Try call again later
Target Busy in Private	Target unit in a Private Call or Call Alert	Try call again later
Target Not Authorized	Target unit not authorized to receive call	Do not call unauthorized unit
Technical Error Unable to Locate Sats	Problem detected with the GPS circuitry	Reboot unit. If problem persists, contact Motorola
Unable to locate Sats	Unit does not have clear view of GPS satellites	Make sure user is out in clear sky and stationary. If problem persists, reboot unit.

Table 3-3. Service Messages (Continued)

Message	Cause	Action
Unknown User	Unit unknown to system	Report problem to provider
User Not Available	Target unit in Private, Group, or Alert call, or is not in service	Try call again later

3.4 Alert Tones

An *i730* unit can send alert tones to the earpiece, speaker, or external speaker. All tones are sent to the earpiece. Press  to determine where some of the tones are sent.

As shown in the following table, alert tones have specific frequencies and cadences/durations. They are grouped according to function; grouped tones have the same tone specifications.

Table 3-4. *i730* Alert Tones

Tone	Low	High	Freq	Cadence	When Tone Occurs
Automatic Callback	Ear	Spkr	1800Hz	2x (24ms on+24ms off) + 48ms on	Voice channel for prior request
Call Alert Acknowledgment Received	Ear	Spkr	1800Hz	2x (80ms off+80ms on)	Call Alert successfully sent
Call Alert No Ack Received	Ear	Spkr	900Hz	1x500ms on	Call Alert fails
Call Alert Received	Spkr	Spkr	2300Hz	4x (150ms off+150ms on) every 10 seconds	Call Alert received
Call Alert Sent	Ear	Spkr	1800Hz	2x (80ms off+80ms on)	Call Alert acknowledged by FNE
Call Waiting Received	Ear	Ear	440Hz	2x(300ms off+300ms on) every 5 seconds	Phone call received while another call is active
Clear to Send	Ear	Spkr	2300Hz	1x50ms on	Reception inhibited; clear to transmit
Data Ringer	Ear	Spkr	2091/ 2823Hz	14x (80ms on 2091Hz + 100ms on 2823Hz + 2.5 seconds off	Unit receives an incoming circuit data call
DTMF (0-9, #, *)	Ear	Ear	DTMF	Continuous	DTMF is transmitted
Earpiece Volume Set	Ear	Ear	1000Hz	Continuous	Earpiece volume changed on quiet channel or in Programming Menu (PRGM)
Group Call Alert	Spkr	Spkr	2300Hz	2x (150ms off+150ms on)	Group call received
In Service	Spkr	Spkr	2300Hz	1x50ms on	Entering in-service mode
Interconnect Busy	Ear	Ear	480/ 620Hz	1s off + 1s on 480Hz; 1s off +1s on 620Hz continuous	Interconnect channel or line is busy

Table 3-4. i730 Alert Tones (Continued)

Tone	Low	High	Freq	Cadence	When Tone Occurs
Invalid Key	Ear	Ear	900Hz	1x80ms on	Invalid key pressed
Low Battery in Idle	Spkr	Spkr	2300Hz	24ms on+24ms off + 24ms on+240ms off + 24ms on+24ms off + 24ms on+30ms off every 30 seconds	Battery below preset value. (Tone sounds from earpiece if in low audio during a dispatch or interconnect call.)
Keypad Volume Set	Ear	Ear	1800Hz	Continuous	Keypad volume changed on quiet channel or in Programming Menu
Message Mail Received in Idle	Spkr	Spkr	2400/ 2743Hz	8x(64ms on 2400Hz + 64ms on 2743Hz) every 30 seconds	Message mail received while unit is idle
Msg Mail Received in Interconnect	Ear	Ear	2400/ 2743Hz	8x(64ms on 2400Hz + 64ms on 2743Hz) every 30 seconds	Message mail received while unit is in interconnect mode
Message Volume Set	Spkr	Spkr	2400/ 2743Hz	8x(64ms on 2400Hz + 64ms on 2743Hz) continuous	Message volume changed on quiet channel or in Programming Menu
Net Alert	Ear	Spkr	880Hz, 1760Hz/ 330Hz, 990Hz	5x (50ms on 880Hz + 50ms on 1760Hz) 8x (50ms on 330Hz + 50ms on 990Hz) repeated every 750ms	Net alert received while in idle
One Minute Beep	Ear	Ear	2300Hz	1x 50ms on	During interconnect calls
Phone Fast Busy	Ear	Ear	480/ 620Hz	0.25s on+0.25s off 480Hz 0.25s on+0.25s off 620Hz continuous	Call failed (system busy, out of service, or trouble with network)
Phone Redial Alert	Spkr	Spkr	2091/ 2556Hz	14x(24ms on 2091Hz + 24ms on 2556Hz)	Phone redial successful

Table 3-4. i730 Alert Tones (Continued)

Tone	Low	High	Freq	Cadence	When Tone Occurs
Phone Ring (U.S.)	Spkr	Spkr	2091/ 2556Hz 2230/ 2040Hz 2310/ 2820Hz 3240/ 2140Hz 3160/ 1980/ 2580Hz 2540/ 2300/ 2030Hz 2740/ 3200Hz 2500Hz 2580/ 3200/ 2040Hz	Available ringer tones: 14x(24ms on 2091Hz + 24ms on 2556Hz) + 2.5s off 14x(64ms on 2230Hz + 64ms on 2040Hz) + 2.5s off 3x(400ms on 2310Hz + 400ms on 2820Hz) + 2.5s off 14x(38ms on 3240Hz + 38ms on 2140Hz) + 2.5s off 1x(200ms on 3160Hz + 100ms on 1980Hz + 200ms on 2580Hz) + 2.5s off 1x(200ms on 2540Hz + 200ms on 2300Hz + 200ms on 2030Hz) + 2.5s off 1x(150ms on 2740Hz + 150ms on 3200Hz + 150ms on 2740Hz) + 2.5s off 1x(200ms on 2500Hz + 200ms off + 200ms on 2500Hz + 200ms off + 200ms on 2500Hz) + 2.5s off 1x(200ms on 2580Hz + 200ms on 3200Hz + 200ms on 2040Hz) + 2.5s off	Phone call received
Phone Ring Back	Ear	Ear	440/ 480Hz	2s on+4s off 440Hz; 2s on+4s off 480Hz	Called phone is ringing
Private Call Received	Spkr	Spkr	2300Hz	2x (88ms off+88ms on)	Private call received
Reject	Ear	Spkr	900Hz	1x500ms on	Requested service denied or failed
Ringer Volume Set	Spkr	Spkr	2091/ 2556Hz	24ms on 2091Hz + 24ms on 2556Hz continuous	Ringer volume changed
Sat No Fix	Spkr	Spkr	900 Hz	1x500ms on	Unable to fix on satellite
Self-Test Fail	Spkr	Spkr	900Hz	1x500ms on	Self test fails on power up
Speaker Volume Set	Spkr	Spkr	1000Hz	Continuous	Volume changed on quiet channel or in Programming Menu
System Busy	Ear	Spkr	480/ 620Hz	4x(0.25s on+0.25s off) 480Hz; 4x (0.25s on+ 0.25s off) 620Hz	All channels are busy
Talk Permit	Ear	Spkr	1800Hz	2x (24ms on+24ms off) + 48ms on	PTT transmission accepted

Table 3-4. i730 Alert Tones (Continued)



Tone	Low	High	Freq	Cadence	When Tone Occurs
Talk Prohibit	Ear	Spkr	900Hz	Continuous	PTT transmission not allowed
TOT Warning	Ear	Spkr	900Hz	1x80ms on	Transmission rights expiring
Valid Key Press	Ear	Ear	1800Hz	1x80ms on	Valid key pressed or unit powered up
Voice Mail Received in Idle	Spkr	Spkr	2400/ 2743Hz	8x(64ms on 2400Hz + 64ms on 2743Hz) every 30 seconds	Voice mail received while unit is idle
Voice Mail Received in Interconnect	Ear	Ear	2400/ 2743Hz	8x(64ms on 2400Hz + 64ms on 2743Hz) every 30 seconds	Voice mail received while unit is in interconnect mode

3.5 Using the Optional Vibrate Function

The vibrate function (VibraCall) notifies the user of incoming phone or dispatch calls, DC/GC calls, messages, notifications, and call alerts.

If the unit is set for Vibrate in any mode, it will vibrate for 1/2 sec during the power-up sequence.

To set unit to vibrate for all calls:

1. Using the keypad, press .
2. Scroll to **Ring Tones**, and then press .
3. Scroll to **VibeAll**, and then press .
4. Scroll left or right to set **VibeAll** to **On**.
5. After you select a Vibrate mode, the unit vibrates for 1/2 sec while exiting the menu.

The following table describes the cadence for each vibrator mode:

Table 3-5. Vibrator Settings

Mode	Cadence
VibeAll or Selectable Vibrate	2x(500ms on, 500ms off) + 500ms on + 2.5 sec. off
Ring Tones	Three Vibrate Only cadences, followed by an audible ring tone until answered or party hangs up
Off	Turns off the vibrator function

To set unit to vibrate for Direct Connect and Group Connect calls only:

1. From the main menu, select **Settings > 2-Way Radio > Alert Type**.
2. If **Alert Type** does not appear, from the main menu select **Ring Tones**. Make sure **VibeAll** or **SilentAll** is set to **Off**. Repeat step 1.
3. Press **Ⓜ** to change.
4. Scroll to **Vibe**.
5. Press **Ⓜ** to select.

CHAPTER 4

PREPARING FOR BASIC LEVEL TESTING

To prepare the unit for testing, the antenna must first be removed.



WARNING: When replacing the antenna, be sure to use the appropriate assembly for your model. Failure to use proper antenna assembly constitutes an FCC Grant Violation.

4.1 Removing the Antenna Assembly

Equipment Required: None.

Preparation: Unit is powered off.

1. Grasp antenna base and torque with a counter-clockwise rotation (see Figure 4-1).
2. Slide antenna whip out from housing completely.



Figure 4-1.

4.2 Installing the Antenna Assembly

Equipment Required: T6 Torx bit driver, extended tip.

Preparation: Unit is powered off.

1. Insert antenna whip in antenna housing while turning until antenna screw threads engage.
2. Firmly grip the antenna base and screw into base in clockwise motion. Must screw in easily. See Figure 4-2.
3. Tighten enough so that antenna does not loosen from base, approximately 2.5 in.oz. Do not overtighten.



Figure 4-2.

4.3 Additional Test Equipment

The following equipment is useful when testing an *i730* unit: a reference unit, a reference SIM card, and reference accessories. For a list of recommended test and programming equipment used to troubleshoot the *i730* unit, see *Appendix A: Ordering Replacement Parts and Kits*.

4.3.1 Reference Unit

Use a *reference unit* (i730 unit known to be in good working order) to verify the accuracy of some tests. You may want to set the Auto Answer Settings Menu setting so that the reference unit automatically answers incoming calls for testing purposes.

4.3.2 Reference Accessories

Use *reference accessories* (accessories known to be in good working order) to verify the accuracy of some tests.

This page intentionally left blank.

CHAPTER 5

BASIC LEVEL CHECKS AND SELF TESTS

Before you perform basic troubleshooting and self tests on an *i730* unit, determine if any special conditions could affect testing and check the units for defective parts.

There are five categories of basic tests:

- Preventive maintenance
- Mechanical/electrical checks
- Troubleshooting
- Self tests
- Technician tests

Test procedures are listed in the order in which they should be implemented. Each test contains a description of what it does and the approximate time needed to perform it. For your convenience, a checklist is included that can be used to ensure that all the necessary tests are conducted.

5.1 Customer Care

It is sometimes helpful to contact your regional Customer Care representative to determine if the customer has service or billing issues or is known to be using the unit in a poorly covered area. The representative also can inform you if there are system outages or known unit defects.

5.2 Test Conditions

During testing, ensure the following antenna conditions are adhered to. Reset conditions can be comparatively difficult to diagnose.

5.2.1 Antenna Condition

For intermittent or no transmit problems, ensure the antenna stays fully extended or fully collapsed at all times, never partially extended. If the antenna is loose or collapses halfway down, the unit can lose up to 20 dB of radiated power.

5.2.2 Reset Condition

A reset condition can be the most difficult failure to duplicate because a reset can be caused by software, hardware, system, accessory, and coverage problems. A severe hardware failure usually can be detected immediately.

5.3 Basic-Level Test Checklist

Use the following checklist to ensure that all the necessary tests are performed and to provide a tracking mechanism in case the unit is sent to the next level of service. Check the appropriate box for each test performed and indicate whether or not the test was completed successfully.

Table 5-1. Basic-Level Test Checklist

Done	Test	Pass	Fail
	Shock and Pressure		
	SIM Card Swap		
	Accessory Swap		
	Lockup		
	Battery Connections		
	Voltage Recognition		
	GPS Receiver		
	Passcode		
	Programming Menu Settings		
	Call Performance		
	Audio Loopback		
	ESN and IMEI Matching		
	Level Set		
	Engineering Debug Check		
	Codeplug Repair Procedure		
	Codeplug Troubleshooting		
	Corrupted Software Repair Procedure		

5.4 Preventive Maintenance

Although the unit does not require a scheduled preventive maintenance program, a visual inspection and cleaning is recommended before testing begins.

NOTE: Do not use aerosol sprays, tuner cleaners, or other chemicals to clean the unit. Damage to the plastic surfaces might occur.

To clean the unit (approx. 3 min.):

1. Prepare a **0.5%** solution of a mild dishwashing detergent and water.
2. Apply the solution sparingly to the external surfaces of the unit.
3. Remove any dirt from the unit using a stiff, non-metallic, short-bristled brush.

4. Wipe and dry the unit with a soft, absorbent, lint-free cloth. Make sure that there are no damp spots on the connectors or in cracks and crevices.

5.5 Mechanical and Electrical Checks

Before conducting more complex tests, clean and check the unit for any mechanical defects that might cause or contribute to the problem.

The following tests constitute the mechanical and electrical checks of the unit:

- Shock and Pressure
- SIM Card Swap
- Accessory Swap
- Lockup
- Battery Connections
- GPS Receiver
- Voltage Recognition

5.5.1 Shock and Pressure Test

Use this test to check the ability of the unit to withstand shock and pressure.

NOTE: Perform this test with the rear cover securely in place and antenna completely pushed in.

To perform the shock and pressure test (test time approx. 3 min.):

1. Power up the unit.
2. Slap the front (display), sides, and back (battery) of the unit into the palm of your hand.

If the unit turns off, displays **Reset**, or goes red, retry this test with a battery known to be in good working condition. Verify that the battery contacts are clean.

If the original battery is bad, replace it. If the reset problem persists, replace the unit.

3. Use your thumbs to apply pressure to the front (display), sides, and back (battery) of the unit.

If the unit turns off, displays **Reset**, or the LED goes red, retry this test with a battery known to be in good working condition.

If the original battery is bad, replace it. If the reset problem persists, replace the unit.

4. Power down the unit. Send the defective unit to the iDEN Radio Support Center.

5.5.2 SIM Card Swap Test

Use this test to determine if the SIM card is defective, or if the unit is defective.

To perform the SIM card swap (test time approx. 5 min.):

1. Power off the unit, and then remove the battery.
2. Remove the SIM card from the unit (see “Removing a SIM Card” on page 1-6).
3. Clean the SIM card, if necessary, by wiping its surfaces with a clean, static-free cloth, and then check the contact areas in the unit for foreign material, damage, or other defects.
4. Replace the SIM card with the test (reference) SIM card. Ensure the test SIM card is clean.
5. Power on the unit, and verify that the test SIM card works with the unit.

If the unit works, the customer’s SIM card is defective and should be replaced, or the problem is due to operator error, system, or carrier. If the unit does not work, the unit is defective and should be sent to the *iDEN* Radio Support Center.

NOTE: If a defective SIM card is replaced with a new card or test card, all personal information (voice notes, datebook entries, etc.) that was stored on the original card will be lost.

6. Install the customer’s SIM card in a test (reference) unit.

If the test unit works, the customer’s unit is defective and should be sent to the *iDEN* Radio Support Center

5.5.3 Accessory Swap Test

Use this test to determine if the unit’s accessories are defective.

NOTE: When adding or removing accessories, the full-sized screen displays “Device Attached” or “Device Detached” and external one-line screen displays “Device.”

To perform the accessory swap (test time approx. 5 min.):

1. Remove the accessory and check the contact areas for foreign material, damage, or other defects.
2. Replace the problem accessory with the reference accessory.
3. Verify the reference accessory works with the unit.

If the reference accessory works, the customer’s accessory is defective and should be replaced.

4. Verify the customer’s accessory works with a reference unit.

If the accessory works, the customer’s unit is defective and should be sent to the *iDEN* Radio Support Center.

5.5.4 Lockup Test

Use this test to determine if the unit locks up when keys are pressed or when it is powered down.

To perform the lockup test (test time approx. 6 min.):

1. Power up the unit.
2. Press  to clear display inputs.
3. Press each of the alphanumeric keys to see if the unit responds. If the unit does not respond to a pressed key, remove the battery to cycle power on.

If the problem persists after several tries, replace the unit.

5.5.5 Battery Connections Test

Use this test to check the battery connections in the unit.

To perform the battery connections test (test time approx. 5 min.):

1. Remove the battery cover and battery from the unit.
2. Inspect the battery for physical damage.

If damage is evident, replace the battery.

3. Insert and remove the battery several times to check the battery connections and back plate of the unit.

If either components are damaged, replace the unit.

4. Check the battery contacts for foreign material. Use a gold contact cleaning pen (see *Appendix A: Ordering Replacement Parts & Kits* for part number) to clean the contact area on the battery.



CAUTION: Do not use a pencil eraser or similar material to clean the contacts. If you do, damage can occur to the contacts.

5. Check the battery cover to ensure it fits and attaches properly to the back of the unit. Replace, if necessary.
6. Use a pencil or similar object to depress the battery contacts. They should spring back to their original position.

If the battery contacts do not spring back, they are damaged. Replace the unit.

5.5.6 Testing the GPS Receiver

The GPS receiver does not require alignment. The functionality of the receiver can be checked using the autonomous mode feature.

Equipment Required: a known good *i730* radio, or a commercial GPS receiver.

To test this function:

1. Move the unit to an open sky area, preferably outside—away from tall buildings and foliage.
2. With the unit turned on, press .

3. Scroll until the **GPS** menu option is highlighted.
4. Press SELECT.
5. Scroll down on the **GPS** menu until the “POSITION” option is selected.
6. Press SELECT. The unit will display a “Position” information sheet.
7. Press RFRSH. The unit will respond with “*Scanning for Satellites*” or “*Satellite Data Is Outdated, Continue?*” depending upon whether the GPS Almanac is up-to-date or not.
8. If the unit responds with “*Satellite Data is Outdated, Continue?*” press YES, otherwise, no action is required. The unit is searching for satellites. Once it has obtained a position fix, the unit will display the “Position” information sheet again. This could take as long as 10 minutes.



CAUTION: The unit must be held in a fixed position during the time that it is searching for satellites.

9. Scroll down until the position coordinates are displayed. Compare these position coordinates to a known good *i730* unit or a commercial GPS receiver. If a commercial GPS receiver is used, the coordinates must be displayed according to the WGS84 standard

5.5.7 Voltage Recognition Test

Use this test to check the voltage-recognition circuit in the unit. To accomplish this test, the unit must first be registered on an *iDEN* system.

Compare the readings on the unit under test with the readings on a reference unit.

To perform the voltage recognition test (test time approx. 4 min.):

1. Perform the Battery Connections test.
2. Power up the unit with a fully charged battery that is known to be in good working order. Three voltage bars (4 Vdc) should appear on the Battery Strength icon.

Note that:

0 bars \cong 0–10% of full charge

1 bar \cong 11–34% of full charge

2 bars \cong 35–64% of full charge

3 bars \cong 65–100% of full charge

3. Complete a Direct Call and monitor the Battery Strength icon while the **Push- to-Talk (PTT)** button is pressed.
4. Power down the unit.

If this test is successful, place the unit’s battery in the reference unit and re-run the test.

5.6 Troubleshooting

Troubleshooting can help identify the problem and determine the next action to take (continue testing, replace parts, or send unit to the Radio Support Center). Refer to the *iDEN Customer Care Troubleshooting Guide* for information on how to perform common troubleshooting procedures.

5.7 Self-Test Procedures

An *i730* unit allows you to conduct automatic self tests to ensure that it is working properly. Self-test procedures include gathering information from the unit's displays and testing the functionality of basic components. These procedures usually do not require test equipment other than a reference SIM card.

The following self-tests can be performed on an *i730* unit:

- Passcode
- Programming Menu Settings
- Call Performance

5.7.1 Passcode Test

Use this test to determine the passcode for the unit.

To perform the passcode test (test time approx. 5 min.):

1. Power on the unit.
2. If the display reads *Unit Locked Enter Code*, enter **0000** or the 4-digit code provided by the customer. (If the customer has changed the passcode but does not remember the new code, read the codeplug to determine the passcode.)
3. If the passcode unlocks the unit, from the **Main Menu**, select **Settings > Security > Phone Lock**, and press  under **Off**.

If the unit does not unlock, repeat the test. If the problem persists, send the unit to the field level of service.

NOTE: If applicable, ensure that the unit's codeplug file is copied and retained for future use.

5.7.2 Programming Menu Settings Check

Use this test to verify that the unit's menu settings perform correctly.

To perform the settings check (test time approx. 10 min.):

Display/Info

The Display/Info menu controls how the keypad and display appear:

- **Backlight** — controls how long backlight stays on after you make or receive a call.

- **Clock** — controls whether the time and date appears on the idle screen, sets the format of the time and date, and sets the year.
- **Contrast** — sets the contrast on the display. To set the contrast of the display:
 1. From the main menu, select **Settings > Display/Info > Contrast**.
 2. Press **Ⓚ** to change.
 3. Scroll left or right to set the contrast.
 4. Press **Ⓚ**.
- **Language** — sets the language that your phone displays.

Phone Calls Features

The Phone Calls menu controls how your phone handles phone calls:

- **SetLine** — sets phone line 1 or phone line 2 as the active line for outgoing calls.
- **AnyKeyAns** — If this feature is on, you can answer calls by pressing any key on the keypad.
- **AutoRedial** — sets your phone to automatically redial calls you make when the system is busy.
- **CallWaiting** — To turn off Call Waiting for the next call you make or receive:
 1. From the main menu, select **Settings > Phone Calls > Call Waiting**.
 2. Press **Ⓚ** to change.
 3. Scroll to **Off**.
 4. Press **Ⓚ**. CallWaiting is turned back on when you end the call.
- **Auto Ans** — sets your phone to automatically answer an incoming call after a specified number of rings. When this feature is on, the phone answers by connecting you to the caller; it does not send the call to voice mail, unless you are out of coverage or on the line.
- **Minute Beep** — causes beep to sound every minute of an active call.
- **CallDuration** — causes the duration of a call to appear on the phones display when the call ends.
- **TTY** — lets you use your phone with a TTY device. To use your phone to make phone calls using a teletypewriter (TTY) device:
 1. Connect one end of a 2.5 mm cable into the audio jack on your phone. Connect the other end of the cable to your TTY device.
 2. Make sure that your phone's TTY feature is on and select the TTY mode you want to use.
 3. Use your phone to enter phone numbers and make calls.
- **Notifications** — To control whether your phone sounds message notification tones while you are on phone calls:

1. From the main menu, select **Settings > Phone Calls > Notifications**.
2. Choose the option you want:
Receive All — Tones sound during calls for all types of messages.
Msg Mail Only — Tones sound during calls for mail messages; tones for all other types of messages are held until you end calls.
Delay All—Tones for all types of messages are held until you end calls.
3. Press **OK**.
Tip: To set notifications options during a call: Press **OK**. Select **Notifications**.

DC/GC Options

The DC/GC menu controls how your phone handles Direct Connect (DC) and Group Connect (GC):

- **Tkgroup Silent** — controls whether you hear group calls or call alerts to your Talkgroup. To receive group calls made to a Talkgroup, you must join the Talkgroup. You can belong to only one Talkgroup at a time. When you join a new Talkgroup, you no longer belong to your previous Talkgroup. To join a Talkgroup:
 1. Press **#**. Then enter the Talkgroup number using the keypad.
 - or-
 2. Choose the Talkgroup name from Contacts or recent calls list.
- **Tkgroup Area** — lets you name Talkgroups and choose your Talkgroup area.
- **One Touch DC** — One Touch PTT sets your phone to call the most recent Private ID on the recent calls list, or to a Private ID you choose, every time you press the PTT button. To set your phone to call the most recent Private ID on the recent calls list:
 1. From the main menu, select **Settings > DC/GC Options > One Touch DC**.
 2. Scroll to **Last Call**.
 3. Press **OK**.
- **AlertType**— sets your phone to make no sound when you receive DC and GC calls. To set your phone to vibrate instead of making a sound when you receive DC and GC calls, even if you want your phone to ring for other features:
 1. From the main menu, select **Settings > DC/GC Options > Alert Type**.
 If **Alert Type** does not appear, from the main menu select **Ring Tones**. Make sure **VibrateAll** or **SilentAll** is set to **Off**. Repeat step 1.
 2. Press **OK** to change.
 3. Scroll to **Vibe**.
 4. Press **OK** under Select.
 If your phone does not include a vibrate feature, you can still set your phone make no sound. Scroll to **Silent** in step 3.

Volume Features



The Volume menu sets the volume of sounds your phone makes:

- **Line1** — sets ringer volume for phone line 1.
- **Line2** — sets ringer volume for phone line 2.
- **Messages** — sets the volume of message notifications.
- **Earpiece** — sets the volume of sound coming out of the earpiece.
- **Speaker** — sets the volume of sound coming out of the speaker.
- **Keypad** — sets the volume of sound associated with pressing keys and buttons.
- **Data** —sets the volume of sounds that notify you that you are receiving a circuit data call.

Security Features



The Security menu lets turn security features on and off and change passwords:

- **Phone Lock** — turns on a feature that locks your phone, either immediately or automatically after a set period of inactivity. An unlock code is required to enable this feature, to unlock the phone, and to set a new Unlock code. Contact your service provider for your default unlock code.
- **KeypadLock**— locks the phone's keypad, either immediately or automatically after a set period of inactivity. To lock the keypad:

1. From the idle screen, press .
2. Press .

If you press a key while the keypad is locked, instructions for unlocking the keypad display briefly.

To unlock the keypad:

3. From the idle screen, press .
4. Press .

While the keypad is locked, you can respond to incoming calls, messages, and alerts just as you do when the keypad is not locked. When finished, press  to return to the idle screen. The keypad remains locked.

- **SIMPIN**— enables and disables your phone's SIM PIN security feature. When the SIM PIN requirement is on, you are prompted to enter your PIN each time you turn on your phone.

Note: If a SIM PIN is required, your phone will not function until the SIM PIN is entered, except for making emergency calls. When the PIN requirement is off, your phone can be used without entering a PIN.

Important: When the SIM PIN requirement is off, the personal data on your SIM card is not protected. Anyone can use your phone and access your personal data.

1. From the main menu, select **Settings > Security > SIM PIN**.
 2. Scroll to **On** or **Off**.
 3. Press **Ⓚ**.
 4. Enter the current SIM PIN.
 5. Press **Ⓚ**.
- **GPS PIN** — enables and disables your phone's GPS PIN security feature. To turn the GPS Enabled security feature on or off:
 1. From the main menu, select **Settings > Security > GPS PIN**.
 2. Scroll to **On** or **Off**.
 3. Press **Ⓚ**.
 4. Enter the current GPS PIN.

Note: When you receive your phone, your GPS PIN is 0000.
 5. Press **Ⓚ**.

To change your GPS PIN:

 1. From the main menu, select **Settings > Security > Change Password > GPS PIN**.
 2. Enter the current GPS PIN.

Note: When you receive your phone, your GPS PIN is 0000.
 3. Press **Ⓚ**.
 4. Enter the new 4- to 8-digit GPS PIN.
 5. Press **Ⓚ**.
 6. Enter the new 4- to 8-digit GPS PIN to confirm.
 7. Press **Ⓚ**.
 - **Change Passwords** — changes your phone unlock code, security code SIM PIN, and GPS PIN.

Advanced Features

The Advanced menu contains advanced and rarely used Settings features.

- **Alert Timeout** — controls the amount of time a tone continues to sound when you receive a message notification or call alert.

- **Headset/Spker**—If you use a headset or similar device with your phone, you can set your phone to send incoming sound to the headset only, or to the headset and the speaker at the same time:
 1. From the main menu, select **Settings > Advanced > Headset/Spker**.
 2. Press **Ⓚ**.
 3. Scroll to **HdsetOnly** to send incoming sound to the headset only.
-or-
Scroll to **Hdset&Spker** to send incoming sound to the headset and the speaker at the same time.
 4. Press **Ⓚ**.
- **Connectivity** — **Network ID** sets the phone's network IDs and their roaming options under the direction of your service provider; **Master Reset** lets your service provider to reset your service in the event of a security or provisioning problem.
- **Reset Defaults** — **Reset Settings** returns all settings to their original defaults; **Reset All** returns all settings to their original defaults and erases all stored lists. Use only under the direction of your service provider.
- **Return to Home** — controls how long the recent calls list displays after calls.
- **Phone Only** — prevents your phone from making or receiving Private calls or group calls.
- **BaudRate** — sets the baud rate at which your phone communicates with a laptop computer, PC, or similar device.

5.7.3 Call Performance Test

Use this test to verify the unit's ability to complete interconnect and dispatch calls.

NOTE: To prevent FM noise interference during testing, be sure to separate the test units by an appropriate distance.

Required equipment: reference unit

To perform the call performance test (test time approx. 7 min.):

1. Power up the unit. Wait until registration is complete before continuing.
2. Place an interconnect call from the problem unit to the reference unit.
3. Ensure that both units have a signal strength of 3 bars or more.
4. Press **Menu > Settings > Volume** (Speaker Volume), and use the **Volume** keys to set the speaker volume of the problem unit to 3 bars.
5. Verify that the problem unit performs within audio-quality standards.

If defects such as distortion, hum, or screeching exist, replace the unit.

6. Place a dispatch call to another unit in the group.

If defects such as distortion, hum, or screeching exist, replace the unit.

7. To automate this test, turn on the Auto Answer menu setting (**Menu > Settings > Phone Calls**) in the reference unit and place the unit next to a good source of voice audio, such as a tape-recorded speech.

This page intentionally left blank.

CHAPTER 6

BASIC LEVEL TEST MODES AND PROCEDURES

To complete basic testing of an *i730* unit, you must enter a test mode to retrieve data from the unit, and perform the technician tests in the correct sequence with the appropriate equipment.

Test procedures are listed in the order in which they should be implemented. Each test contains a description of what it does, the approximate time needed to perform it, and the type of equipment required (if any).

NOTE: The unit must be powered up and registered before performing most tests.

6.1 Test Modes

Some tests require that a certain mode be entered to conduct the test and/or retrieve data from the unit. The following test modes are used with an *i730* unit:

- Engineering debug mode (includes trace mode)
- Test mode

NOTE: Do not enter these modes until the unit has been powered up and the power-up sequence has been completed.

6.1.1 Entering Debug Mode

Use this procedure to access the debug mode.

To enter debug mode:

1. Power up the unit. Wait until registration is complete before continuing.

NOTE: Steps 2 through 5 must be performed quickly (no more than one second between each key press).

2. Press **#**.
3. Press *****.
4. Press **Menu**.
5. Press the right **Scroll** key. You now are in debug mode.

If you press the option key under **Trace** while in debug mode, you can enter trace mode. To exit trace mode, re-enter debug mode, press the option key under **Trace** again, and then press the option key under **Exit**.

In trace mode, the unit switches every five seconds between debug mode and normal operation to allow you to monitor and sample a variety of signals and signal characteristics, particularly in the SQE/Carrier and multi-data displays.

To exit debug mode, press the option key under **Back**.

6.1.2 Display Screens

Display screens on the *i730* unit provide information that is useful for troubleshooting purposes. These displays appear only when the unit is placed in debug mode (see “Entering Debug Mode on page 6-1).

To navigate through the screens, press the appropriate scroll key to highlight the desired screen, and then press the View option key. To select a choice within a screen, press the Select option key. To exit from a choice or screen, press the Back option key.

Table 6-1. Display Screens

Name	Description
Unit Info • Phone Model • CP Ver • USR Ver • CSD Ver • Software Tegic Flash Packs	Displays the unit model number and product sub ID, such as <i>i730</i> and A. Displays the Codeplug Version. The first half of the line displays the codeplug structure and default version; the second half displays the codeplug bandmap. Version of carrier specific modification to the product code plug. Programmed at shipment. Displays the Customer Static Data version. The first number indicates the customer. The second number indicates the structure revision. The third number indicates the data revision. Displays the current software version programmed in the unit, as well as the software type (RSS model) and build date. Text 9 code version/LDB version. Version of the preferred language: French, Spanish, Hebrew, Korean, or Portugese and the associated Font Pack.
Total Usage	Displays the number of minutes the unit has used a traffic (dispatch and interconnect) or a Packet Data channel since manufacture.
Tx Status	First line displays the SQE/Carrier data: Outbound signal quality, Frequency band, current carrier code, and color. Second line displays Tx power cutback in RSSI. Third line displays current temperature and the difference between the current temperature and temperature 2 seconds ago.
Rx Status	First line displays the SQE/Carrier data: Inbound signal quality, Frequency band, current carrier code, and color. Second line displays Rx power cutback in RSSI. Third line displays AGC Step Attenuator State, Channel Code.
N6:1 Intrcnct	Parameter details for the 6:1 Interconnect Feature enabling transmission of RF-originated messages through the telephone system. Line 1 shows MS , the Mobile Subscriber's ability to support 6:1 Interconnect and FNE , the Fixed Network Equipment's ability to support 6:1 Interconnect respectively. Numbers 0 or 1 indicate No or Yes respectively. Line 2 shows I , Interleave of the current channel, O , Offset of the current channel, and S , Sub-slot of the current channel. Values for Interleave are 1 – 24, Offset values are 0 – 23, and Sub-slot can be A, B or N. Line 3 shows ECC , Extended Color Code and PO , Primary Control Channel Offset of the current carrier. Values for ECC are 0 – 16. Values for PCCH Offset are 0 - 11. During Trace Mode, radio activity such as interconnect, dispatch call, packet data session, registration, or location update information will automatically update every 2 seconds.
GPS	Displays the GPS location, time info, assist, navigation, summary, GPS version.

Table 6-1. Display Screens (Continued)

Name	Description
IMEI/SIM ID	Displays the electronic serial number and SIM ID serial number. The IMEI is the global name assigned to the mobile station at manufacturing time and should correspond to the serial-number tag of the unit. The SIM ID is the SIM electronic serial number and should correspond with the number stamped on the SIM card. Pressing OK allows the IMEI/SIM ID to be traced.
Registr Log	Displays the Dispatch Log, Interconnect Log, Packet Data Log, Mobile IP Log, and Phone Rst Log. Registration Log information is updated when the user deselects and selects the Registr Log choice.
Err/Chan Codes	Displays the physical channel that the unit is connected to or the radio link procedure that is currently active. Also, displays error codes of errors encountered during normal operation if Err/Chan codes is On. At power up, the Err/Chan Codes is Off.
Current Freq	Displays current frequency and band. Pressing OK allows the current frequency and band to be traced.
Dispatch IDs	Displays the Dispatch Group ID affiliated with the unit in the current dispatch-location area. Also, displays the Dispatch Individual ID affiliated with the unit in the current dispatch location. Pressing OK allows the dispatch IDs to be displayed periodically.
Band Info	Displays primary and secondary bands.
Bandmap	Displays the currently selected regional bandmap. Pressing OK allows the bandmap to be displayed periodically.
Hardware	Displays the AFC Offset and Channel Number. Pressing OK allows the hardware parameters to be traced.
Fatal Err/#	Displays the Fatal Error log. This log contains a count of any fatal errors logged during the unit's automatic self test. Optioning clear empties the log.
Flags	Displays the error log. This log contains any errors logged by the unit software. Pressing Menu when it appears displays the Clearall screen in which the user can clear all the logged errors.
Resets	Displays the Reset Error log. This log contains any errors logged when the user resets the unit during operation. The most recent reset appears at the top of the list. Pressing Menu when it appears displays the Clearall screen in which the user can clear all the logged errors.
Coin Cell	Displays the Charger and Battery Voltage.

6.1.3 Entering Test Mode

Use this procedure to access test mode.

To enter test mode:

1. Power up the unit. Wait until the power-up sequence is complete before continuing.

NOTE: Steps 2 through 7 must be performed quickly (no more than one second between each key press).

2. Press #.
3. Press *.
4. Press **Menu** three times.
5. Press the left **Scroll** key.

6. Press **Menu** twice.
7. Press the left **Scroll** key. You now are in test mode.

To exit test mode, press the option key under **Exit**. The unit waits for a few seconds, resets, and then re-registers the unit.

6.2 Test Mode Test Procedures

Enter debug or test mode to perform the following tests:

- Audio Loopback Test
- ESN and IMEI Matching Test
- Level Set Test
- Engineering Debug Check

6.2.1 Audio Loopback Test

Use this test to check the functionality of the microphone and the audio quality of the earpiece. The loopback test checks the unit's audio by passing a test signal from the Codec microphone input to the Codec Rx output.

NOTE: This test also can be performed with the ST-3200 tester.

To perform the audio loopback test (test time approx. 3 min.):

1. Enter test mode.
2. With the Test Mode screen displayed, press .

The right option key changes to **Edit**.

3. Press the option key under Edit.

The right option key changes to **Change**.

4. Press the **Change** option key.
5. Using the bottom scroll key, scroll down the list until **AUDIO1 or 800AUD1** is displayed.
6. Press the **Select** option key.
7. Press the **Back** option key.
8. Press .
9. Press the **Start** option key to begin the actual audio test in the TX On mode.

10. Talk into the microphone. The audio from the earpiece should sound clear.

If there is a problem with the microphone or the earpiece, power down the unit and repeat the test. If the problem persists, send the unit to the field-level Support Facility.

11. Press the **Tx Off** key, and repeat the previous step.

12. Press the **Stop** key to end the test.

6.2.2 ESN and IMEI Matching Test

Use this test to verify that the electronic serial number (ESN) matches the International Mobile Equipment Identifier (IMEI) on the Serial Number label located on the chassis of the unit.

To perform the matching test (test time approx. 6 min.):

1. Power up the unit. Wait until the power-up sequence is complete before continuing.
2. Enter debug mode. The **Unit Info** display appears.
3. Scroll down until the **IMEI/SIM ID** choice is highlighted, then press **View** to view the **IMEI/SIM ID** display.
4. Write down the digits shown in the IMEI line.
5. Verify that this number matches the IMEI on the Serial Number label. The last zero on the label will be missing.

If the numbers do not match, send the unit to the field level of service.

6.2.3 Engineering Debug Check

Use this test to monitor (measure) the data in an *i730* unit.

NOTE: The following procedure describes the sequence of displays accessed via the down scroll key. If you press the up scroll key, the sequence appears in reverse order.

To monitor the data in the unit:

1. Power up the unit. Wait until the power-up sequence is complete before continuing.
2. Enter debug mode The **Unit Info** display appears.
 - a. Press **View** to view the **Phone Model** display, and then press **Select** to view the phone model, such as *i730*.
 - b. Press **Back** to return to the **Unit Info** display, and then scroll down (down scroll key) to highlight the **CP Ver** choice.
 - c. Press **Select** to view the Codeplug Version. The first half of the line displays the codeplug structure and default version; the second half displays the codeplug bandmap.

- d. Press **Back** to return to the **Unit Info** display, and then scroll down to highlight the **CSD Ver** choice.
- e. Press **Select** to view the Customer Static Data version. The first number indicates the customer. The second number indicates the structure revision. The third number indicates the data revision.
3. Press **Back** to return to the **Unit Info** display, and then scroll down to highlight the **Software** choice.
4. Press **Select** to view the current software version programmed in the unit, as well as the software type (RSS model) and build date.
5. Press **Back** twice to return to the **Trace Mode** display.
6. Scroll down to highlight **Total Usage**, and then press **View** to view the **Total Usage** display. This screen displays the number of minutes the unit has used a traffic (dispatch and interconnect) or a Packet Data channel since manufacture.
7. Press **Back** to return to the **Trace Mode** display.
8. Scroll down to highlight **System Status**, and then press **View** to view the **System Status** display. The first line displays the SQE/Carrier data (outbound signal quality, frequency band, current carrier code, and color code). The second line displays the Tx/Rx power (current adjusted transmit output power and receiver input power) of the unit. The third line displays the current temperature and the difference between the current temperature and the temperature two seconds ago.
9. Press **Back** to return to the **Trace Mode** display.
10. Scroll down to highlight **GPS**, and then press **View** to view the **GPS** display.
 - a. **Location** selection displays the number of satellites used to obtain the position fix, the current cell site latitude and longitude, the subscriber unit latitude and altitude information, as well as the last calculated horizontal and vertical accuracy.
11. **Time** selection contains *i*DEN time information used to determine accurate GPS time.
12. **Assist** selection contains the subscriber unit latitude, longitude and horizontal accuracy in meters as well as an indication of whether the data is valid or not.
13. **Navigation** selection contains the heading as well as velocity and velocity error in kilometers/hour.
14. **Summary** selection contains time and longitude/latitude expressed in degrees. Accuracy in meters is also displayed.
15. **GPS Version** contains information about the custom Sirf software used in the unit.
16. Press **Back** to return to the **Trace Mode** display.
17. Scroll down to highlight **IMEI/SIM ID**, and then press **View** to view the **IMEI/SIM ID** display. The IMEI is the global name assigned to the mobile station at manufacturing time and should correspond to the serial-number tag of the unit. The SIM ID is the SIM electronic serial number and should correspond with the number stamped on the SIM card.

18. Press **Back** to return to the **Trace Mode** display.
19. Scroll down to highlight **Registr Log**, and then press **View** to view the **Registr Log** display. This screen displays the Dispatch Log, Interconnect Log, Packet Data Log, Mobile IP Log, and Phone Rst Log. Registration Log information is updated when the user deselects and selects the Registr Log choice.
20. Press **Back** to return to the **Trace Mode** display.
21. Scroll down to highlight **Err/Chan Codes**, and then press **On** to view the **Err/Chan Codes** display. This screen displays the physical channel that the unit is connected to or the radio link procedure that is currently active. Also, displays error codes of errors encountered during normal operation if Err/Chan codes is On. (At power up, Err/Chan Codes is Off)
22. Press **Back** to return to the **Trace Mode** display.
23. Scroll down to highlight **Current Freq**, and then press **View** to view the **Current Freq** display, which shows the current frequency and band.
24. Press **Back** to return to the **Trace Mode** display.
25. Scroll down to highlight **Dispatch IDs**, and then press **View** to view the **Dispatch IDs** display. This screen displays the dispatch group id affiliated with the unit in the current dispatch-location area. Also, displays the dispatch individual id affiliated with the unit in the current dispatch location.
26. Press **Back** to return to the **Trace Mode** display.
27. Scroll down to highlight **Band Info**, and then press **View** to view the **Band Info** display. This screen displays the primary and secondary control channels: Pri Band: 02 for 800 MHz; Sec Band: 02 for 800 MHz and 04 for 900 MHz.
28. Press **Back** to return to the **Trace Mode** display.
29. Scroll down to highlight **Bandmap**, and then press **View** to view the **Bandmap** display. This screen displays the currently selected regional bandmap.
30. Press **Back** to return to the **Trace Mode** display.
31. Scroll down to highlight **Hardware**, and then press **View** to view the **Hardware** display. This screen displays RF Xtal (RF Crystal), a factory-tuned parameter that adjusts the output frequency; Xtal Offset (RF Crystal Warp offset), which is derived during frequency compensation; and Level Set (Level Set value), which regulates the transmit output power of the unit.
32. Press **Back** to return to the **Trace Mode** display.
33. Scroll down to highlight **Fatal Err/#**, and then press **View** to view the **Fatal Err/#** display. This screen displays the Fatal Error log. This log contains a count of any fatal errors logged during the unit's automatic self test.
34. Press **Back** to return to the **Trace Mode** display.
35. Scroll down to highlight **ER Log**, and then press **View** to view the **ER Log** display. This screen displays the error log, which contains any errors logged by the unit software.

36. Press **Back** to return to the **Trace Mode** display.
37. Scroll down to highlight **Resets**, and then press **View** to view the **Resets** display. This screen displays the Reset Error log. This log contains any errors logged when the user resets the unit during operation. The most recent reset appears at the top of the list.

6.3 Technician Test Procedures

Technician tests usually require special equipment to test the functionality of the components in the unit.

The following tests check or repair the functionality of the unit:

- Codeplug Repair Procedure
- Codeplug Troubleshooting
- Corrupted Software Repair Procedure

6.4 Programming the i730 Unit

Use *Radio Service Software (RSS)* to program a new software version or to program codeplug user information. Refer to the *Radio Service Software User's Guide* for information on the setup and use of RSS.

6.5 Connecting the Unit to the RSS Workstation

Some technician tests enter programming information into the unit. To perform these tests, the unit must be correctly connected to the test equipment.

Recommended equipment: data cable RS232 (NKN6560) or USB data cable (NKN6559), computer workstation with RSS installed

NOTE: For a list of recommended programming equipment, applicable part numbers, and descriptions, refer to *Appendix A: Ordering Replacement Parts and Kits*.

To prepare the unit for both codeplug and subscriber code programming using the data cable (Figure 6-1):

1. Attach the miniature 17-pin connector on the data cable to the corresponding connector located at the base of the unit.
2. Attach the other end of the data cable to the serial port or USB port on the RSS computer workstation that is used for testing purposes.

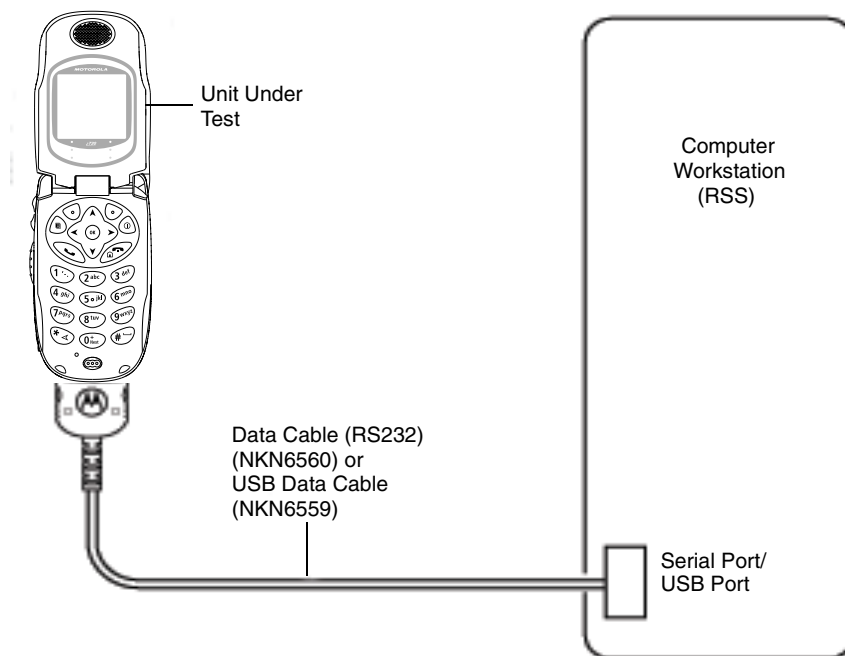

Figure 6-1. Data Cable Programming Setup

Refer to the *Radio Service Software User's Guide* for more information on setting up your test computer as an RSS workstation.

NOTE: For faster codeplug reading, enable the *QuickComm* feature in the RSS configuration setup.

6.5.1 Codeplug Repair Procedure

If the codeplug is corrupted, the unit displays a SELF CHECK ERROR 0800 message. The procedure for repairing a corrupted codeplug is described in the RSS online Help System.

Equipment Required: Computer workstation with RSS installed, data cable RS232 or USB, reference unit (must be the same model as the problem unit).

To access the codeplug Help topic in Windows:

1. Set up your test equipment configuration. See Figure 6-8 for an illustration of this configuration.
2. Start the RSS program.
3. Click on the Help choice on the menu bar, and then select **Contents**. The RSS online Help is displayed.
4. Click on the Troubleshooting link, and follow the detailed directions.

To prevent the loss of call lists, create a backup of the codeplug before attempting any form of modification. Refer to the *Radio Service Software User's Guide* for instructions on reading and saving codeplug information.

6.5.2 Codeplug Troubleshooting

The RSS online Help System topics contain information for troubleshooting codeplug problems. The following error messages are discussed:

- Unable to read the codeplug
- Unable to write partial codeplug
- Unable to write entire codeplug
- Unable to write subscriber software (flashing)
- Unable to write software and codeplug
- Update failed while writing subscriber software
- Update failed while reading radio or writing entire codeplug

6.5.3 Corrupted Software Repair Procedure

Use this test to check for a software failure in the unit. This test corrects units that display SELF-CHECK FAIL 04000 messages.

Required equipment: computer workstation with RSS installed, data cable RS232, or USB cable

To perform the flash test (test time approx. 8 min.):

1. Connect the unit to the computer workstation.
2. Power up the unit. Wait until registration is complete before continuing.
3. If a SELF-CHECK FAIL message is displayed, use the RSS to reflash the latest software into the unit. Make sure the software and codeplug versions match.
4. Place a test call to determine if the unit is operational. If the unit still does not work, there are problems other than the software.

CHAPTER 7

PREPARING FOR FIELD LEVEL TESTING

Field-level testing requires external equipment and support. To conduct field-level troubleshooting and testing of an *i730* unit, you must become familiar with the screen readouts of the recommended test equipment.

Display screens on an *i730* unit provide information that is useful for troubleshooting purposes. Refer to Chapter 3 for information on the displays, errors, alert tones, and messages associated with this unit.

7.1 Preparing Equipment for Testing

To ensure accurate testing of an *i730* unit, it is important that the test equipment function properly.

7.1.1 Calibrating Equipment

Test equipment should be internally calibrated before being used for testing. Note that the internal calibration does not substitute for a factory calibration. For more information, refer to *R-2660 Digital Communications System Analyzer Operator's Manual*.

7.1.2 Checking the RF Cable

Check the cable connection and quality to ensure that the test results are true. Cable length is critical to consistent Rx sensitivity and Tx power measurements. Use a high-quality, shielded, 50-ohm, coaxial cable that is approximately 1.5 feet in length. Place the unit to be tested at least 6 inches from the R-2660 Communications System Analyzer. The cable loss should be less than 2 dB.

7.1.3 Strong-Signal Environments

When using the R-2660 Communications System Analyzer to test a unit in a strong-signal environment (-75 dBm or stronger), change the bandmap of the unit.

For Registration/Call testing: Power up the unit. Immediately after hearing the beep, press **Start** on the R-2660. The unit will lock onto the first strong signal.

7.1.4 Protecting Static-Sensitive Devices

This unit contains static-sensitive devices that must be protected when opening the unit, or storing and transporting any printed-circuit board. Consider the following information to create a proper ground:

- Ground the working surface of your service bench. If possible, use the Motorola Static Protection Assembly (P/N 0180386A82) to ground your service bench. This assembly contains a wrist strap, two ground cords, a table mat, and a floor mat.

- Wear a conductive wrist strap in series with a 100 k Ω resistor to ground.
- Do not wear nylon clothing when handling any printed-circuit board.
- Prior to touching any printed-circuit board, touch an electrical ground to remove any static charge that might have accumulated.

Refer to Service and Repair Note SRN-F1052 for more information. This note is available through:

Motorola Literature Distribution Center

2290 Hammond Drive
Schaumburg, IL 60173
847-576-2826

The following should be considered when storing or transporting a circuit board:

- Place the printed-circuit board in conductive, anti-static material.
- Do not insert the printed-circuit board into conventional plastic “snow” trays used for transporting other devices.

7.2 Using RSS

Use *Radio Service Software (RSS)* to program a new software version or to update user information in the codeplug. Refer to “Connecting the Unit to the RSS Workstation” and the *Radio Service Software User’s Guide* for information on the setup and use of RSS.

NOTE: You can use the RSS online Help for locating specific information about RSS dialog boxes and fields. To access online Help, press **F1** while you are viewing an RSS screen.

If you are using the R-2660A Communications System Analyzer in the *iDEN* mode, which is 6:1 capable, use RSS to program an *i730* unit for **Full Rate** operation. Use the **6:1 Interconnect** softkey for all interconnect testing.

If you are using the R-2660B or later, which is 3:1 capable, use RSS to program an *i730* unit for **Half Rate** operation. Use the **3:1 Interconnect** softkey for all interconnect testing.

In the carrier version of RSS (but not the agent version), you can change interleave values. To access the fields where you can change these interleave values, go to the User Ergonomics dialog box, and then click on the **Interleave** tab.

NOTE: After servicing an *i730* unit, use RSS to reprogram the unit back to its original operating state.

Refer to the *R-2660 Digital Communications System Analyzer Operator’s Manual* for more information on how to set up this equipment for *iDEN* mode testing.

7.3 Connecting an i730 Unit to the R-2660

The R-2660 Communications System Analyzer enables you to monitor and perform tests on an i730 unit. Figure 7-1 shows the i730/R-2660 test setup.

Equipment Required: R-2660, reference SIM card, SMA to N-type RF coaxial cable, battery eliminator, 5.0-12.0 Vdc power supply.

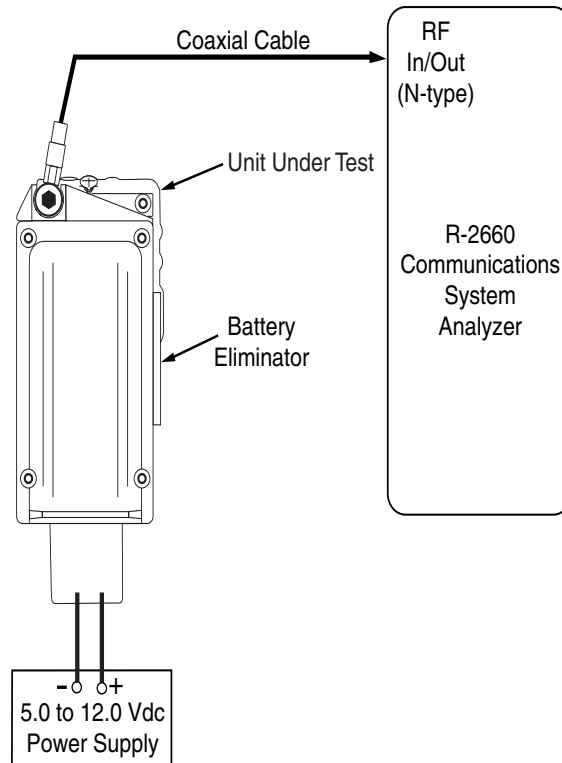

Figure 7-1. R-2660 Setup

To connect the unit to the R-2660:

1. Ensure the unit is powered off, and then turn on the R-2660.
2. Remove the antenna from the unit. See “Removing the Antenna Assembly” on page 4-1 for instructions.
3. Remove the battery cover and battery from the unit, and insert the reference SIM card.
4. Attach the battery eliminator to the back of the unit.
5. Connect the SMA connector of the RF cable to the RF connector on the battery eliminator.
6. Connect the N-type connector of the RF cable to the R-2660 RF In/Out connector.

7. Attach the power leads on the battery eliminator to the DC power supply.



CAUTION: Be very careful to observe polarity when connecting power to the battery eliminator. Also, be sure to protect the test setup from any potential overvoltage condition.

8. Turn on the power supply, and adjust it for an output between 5.0 Vdc and 12.0 Vdc.

NOTE: With the power supply voltage set between 5.0 Vdc and 12.0 Vdc, the battery eliminator will provide a regulated 4.0 Vdc to the unit.

9. Power up the unit.

Refer to the *R-2660 Digital Communications System Analyzer Operator's Manual* for more information on how to use this equipment.

7.3.1 Operating the R-2660

Most of the technician tests performed with the R-2660 Communications System Analyzer require that the analyzer use the Initial Registration test mode.

To enter Initial Registration mode:

1. Turn on the R-2660.
2. Press **DISP** to place the cursor in the Display zone portion of the screen.
3. Use the arrow keys to move the cursor to the **Mode** field.
4. Press **More** until *iDEN MOBILE* appears in the **Mode** field.
5. Press the *iDEN MOBILE* softkey. The RF zone displays **DUPLEX** in the **RF Control** field.
6. Use the arrow keys to move the cursor to the **Meter** field in the display zone.
7. Press **More** until **INITIAL REG** appears in the **Meter** field.
8. Press the **INITIAL REG** softkey. The display zone displays **DISPATCH** in the **Registration Type** field.
9. Press **RF** to move to the RF zone.

10. Enter the appropriate values in the following RF zone fields. These values might be different, depending on your bandmap. Use the arrow keys to move between fields and the keypad to enter values.

Table 7-1. RF Zone Fields and Values

Field	Value
Carr. #	Choose the appropriate carrier number from your bandmap. The Mon. Freq. field displays the associated frequency.
Mon. Freq	Choose the appropriate monitor frequency from your bandmap. The Carr. # field displays the associated carrier frequency.
Offset	800 MHz = +45 MHz; 900 MHz = +39 MHz
Format	iDEN
Mon.	40 dB RF I/O
Gen	-070 dBm RF I/O

11. Press the **DISP** key to return to the Display zone. You now are ready to begin testing.

7.4 Disassembling and Reassembling the i730 Unit

Motorola recommends the service technician follow a prescribed disassembly sequence to access specific items or components of the unit. The *i730* product is an efficiently designed package that incorporates the physical overlap and integration of some modular components. Refer to the *i730* Disassembly Sequence flowcharts for a suggested path to reach specific components.

NOTE: In some cases, the technician may not need to remove certain components to reach others.

7.4.1 i730 Disassembly Sequence Flowchart

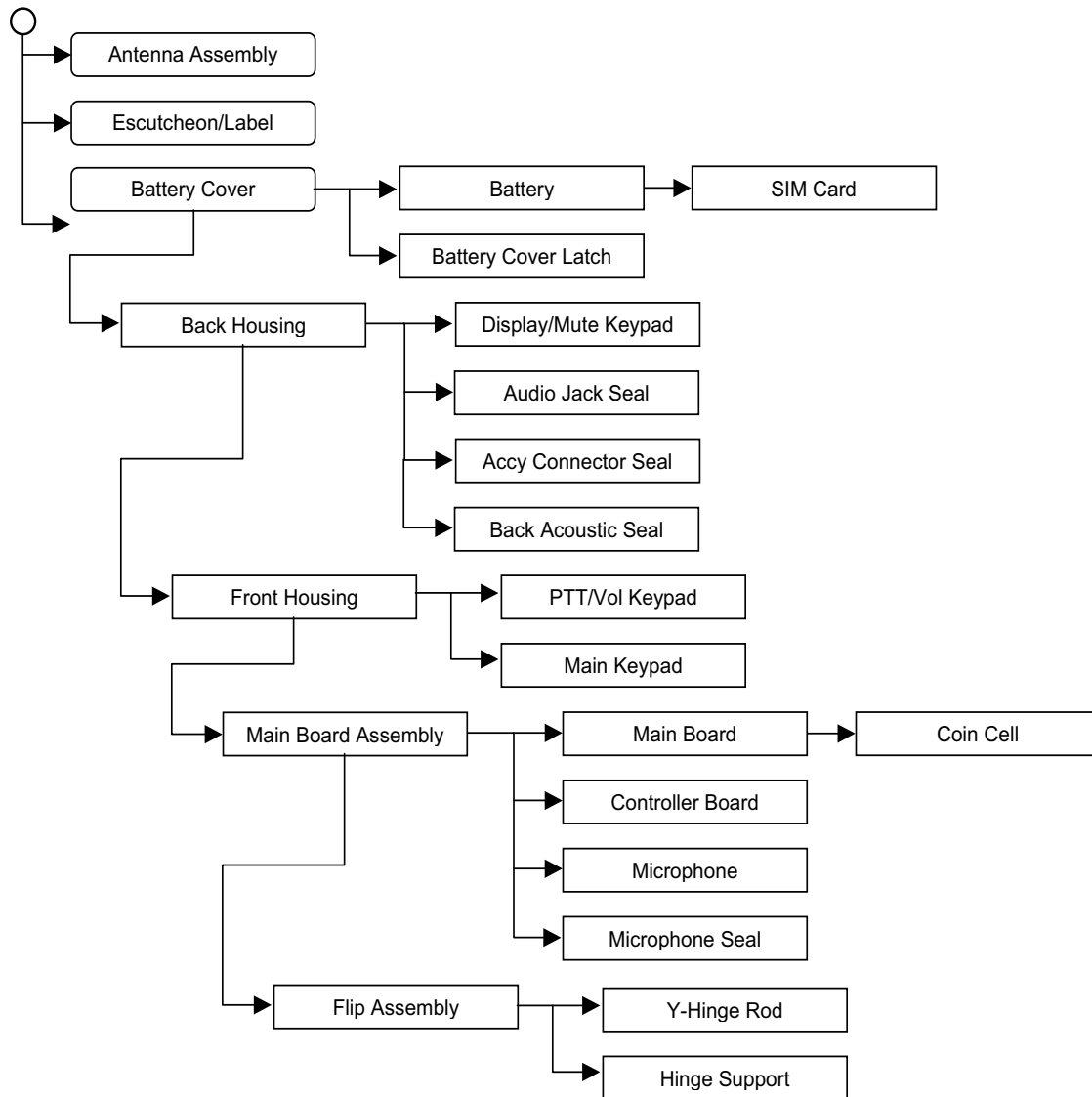

7.5 Disassembly Procedure

7.5.1 Removing the Antenna

See section 4 “Removing and Replacing the Antenna.”

7.5.2 Removing the Back Housing

Equipment Required: T6 Torx bit driver, extended tip.

Preparation: Unit is powered off.

1. Remove the Battery and SIM Card.
2. Remove four T6 screws shown in Figure 7-2.
3. Carefully wiggle apart the two housing halves (see Figure 7-3). Do not strain the flex-strip.



Figure 7-2.

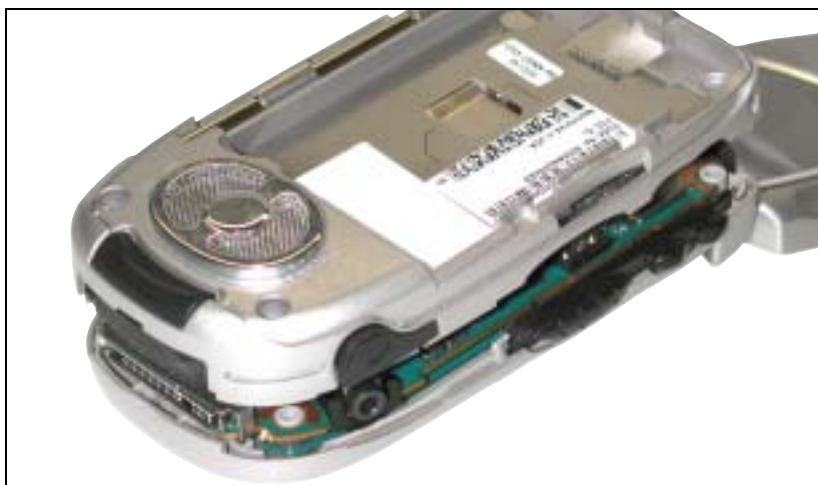

Figure 7-3.

7.5.3 Removing the Display/Mute Keypad, PTT/Volume Keypad, and Audio Jack Seal

Equipment Required: none.

Preparation: Front Housing is separated from Back Housing.

1. Locate Display/Mute Keypad and Audio Jack Seal in the Front Housing (see Figure 7-4). Grasp and pull pad or seal straight out.
2. Locate PTT/Volume Keypad in the Back Housing (see Figure 7-5). Grasp and pull straight out.

NOTE: Keypads have thin metal supports. Do not bend.

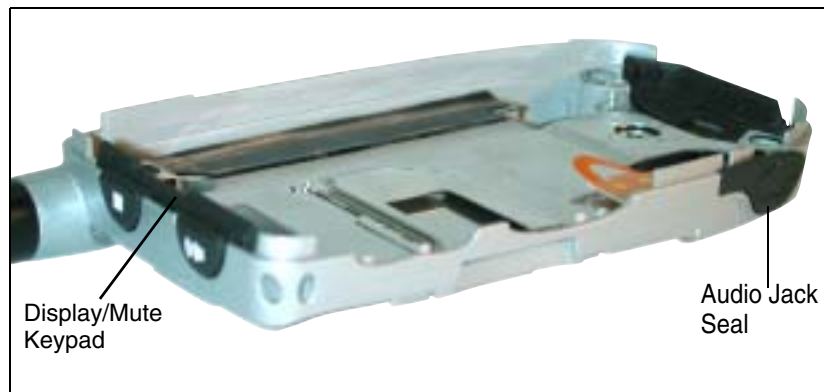

Figure 7-4.

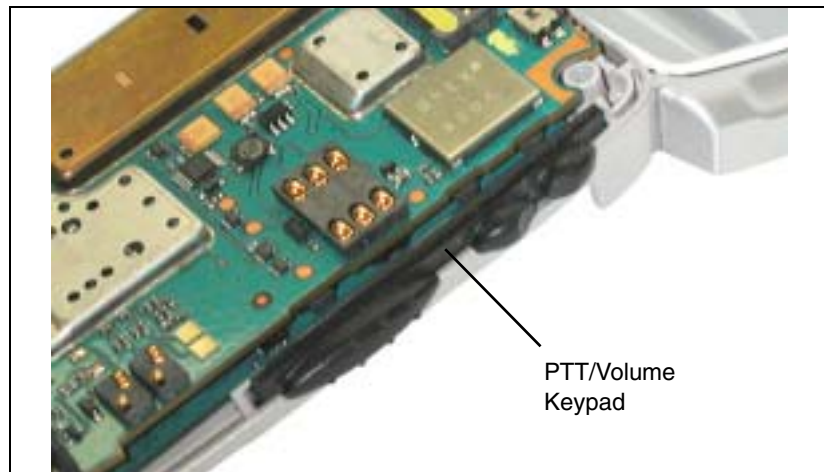

Figure 7-5.

7.5.4 Removing the Main Keypad

Equipment Required: None.

Preparation: Back Housing is removed.

1. Lift the Main and Controller Boards out from their housing bosses as a unit. No strain on Flex-Connector.
2. From the outside, push the Keypad's Scroll/OK button in. Peel out remainder of keypad.

NOTE: Do not pull the keypad at the lower boss — lift the keypad away.



Figure 7-6.

7.5.5 Removing the Flip Assembly

Equipment Required: Black Stick, 1/8" flat-tipped screwdriver.

Preparation: Unit is powered off. Battery and SIM card are removed.

1. Separate Front and Back Housings. Keep Main and Controller Boards in Front Housing.
2. Separate Main and Controller Boards. Do not strain full-sized display Flex-Connector.
3. Separate Flex-Connector from Controller Board. Remove board and Main Keypad.
4. Remove and set aside T4 screw.
5. With unit face up, wedge screwdriver in right-side housing hinge slot to release Flip Y-Hinge. Use technique similar to i90/i60/i95cl flip removal procedure.
6. Y-Hinge and left side Retaining Rod can go in only one way.



CAUTION: Do not remove the left-side Retaining Rod.

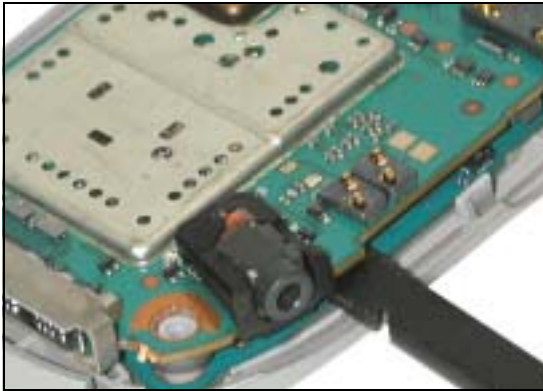

Figure 7-7.



Figure 7-8.



Figure 7-9.



Figure 7-10.



Figure 7-11.



Figure 7-12.

7.5.6 Removing the Coin Cell

Equipment Required: Black Stick, Safety Glasses.

Preparation: Main Board and Controller Boards are separated.

1. Place Main Board with Controller Board Connector facing up.
2. Locate Coin Cell ($\approx 1/4''$ D x $1/16''$ H) between PTT and Volume switches. Use judgement to contain Coin Cell which could pop away from work area when removed from Seat.
3. Approach slot in Coin Cell Seat from “can” side of board with pointed end of Black Stick. Gently push under cell at slot in seat until cell pops up.

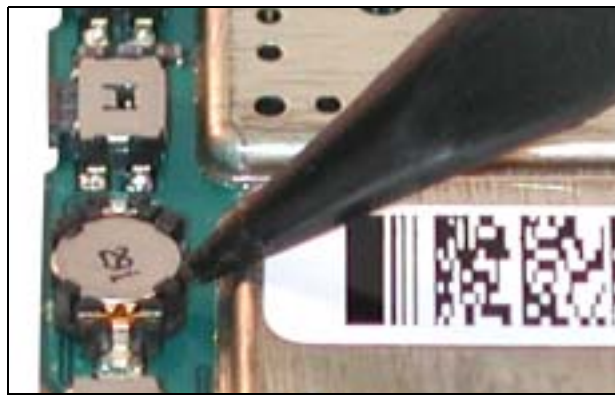

Figure 7-13.

7.5.7 Removing the Microphone

Equipment Required: Black Stick.

Preparation: Separate the Front and Back Housings.

1. Insert pointed end of Stick under the sealing face of the mic.
2. Gently pry up until the mic starts to release. Be careful not to over-stretch the mic seal “wings.”

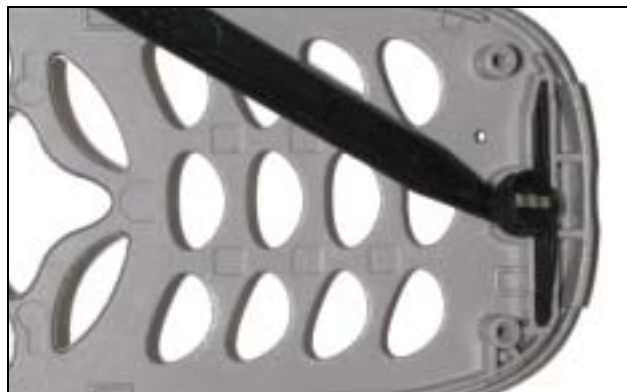

Figure 7-14.

7.6 Assembly Procedures

7.6.1 Installing the Microphone

Equipment Required: Clean tweezers, Black Stick.

Preparation: Clean the Front Housing of any dirt and debris.

1. Grasp microphone with tweezers only. Align in slot with notch to right, elastomer up.
2. Gently tamp down along length. Careful not to deform the mic seal “wings.”

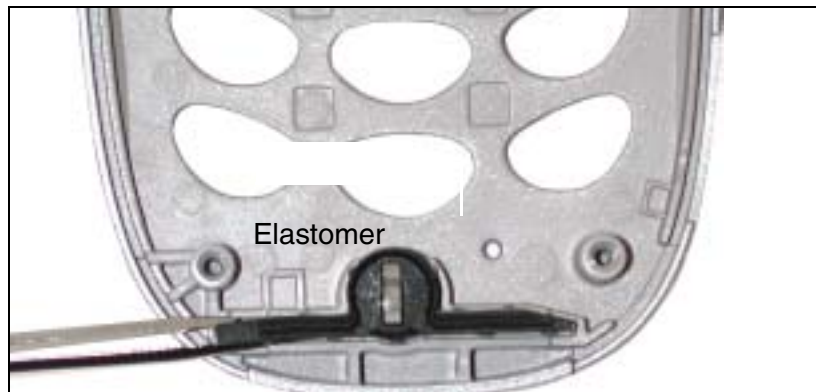

Figure 7-15.

7.6.2 Installing the Flip Assembly

Equipment Required:

Preparation: Clean Front Housing near hinge points.

1. The Flip Assembly should have the left-side Retaining Rod, right-side Y-Hinge Rod, and Center Brace in position.
2. Check that the Flex-Connector ribbon is properly wrapped around the Retaining Rod.
3. Check that the Y-Hinge Rod Collar is properly seated in the Flip Assembly.
4. With the Flip Assembly and Front Housing mated pivot-end to pivot-end, slip Flex-Connector through its slot in the Front Housing.
5. Align Flip Assembly hinges with the Front Housing hinges at an angle to seat Retaining Rod in its left-side slot. Gently push against left-side hinge until Y-Hinge is about to be pushed into its slot.
6. Place back of Front Housing on flat surface while keeping Flip Assembly as flat to the surface as possible to keep Y-Hinge aligned with its slot.
7. Push in Y-Hinge. Push the Flip Assembly until it snaps into its seated position.

8. Screw in the T4. Check that the Flex-Connector and Flip action are not binding.



Figure 7-16.



Figure 7-17.



Figure 7-18.

7.6.3 Installing the Main Keypad

Equipment Required: None.

Preparation: Clean Front Housing of any dirt and debris.

1. Align keypad with bosses inside Front Housing.

2. Check around perimeter for proper seat.



Figure 7-19.

7.6.4 Installing the Top Button Keypad and Audio Jack Seal

Equipment Required: None.

Preparation: Check slots for any dirt and debris.

1. Align Top Button Keypad and Audio Jack Seal in the Back Housing Assembly.
2. Tamp down into place.

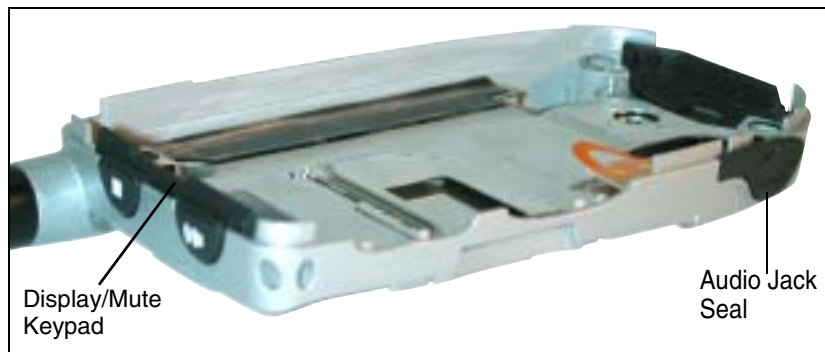

Figure 7-20.

7.6.5 Installing the Coin Cell

Equipment Required: Tweezers, Black Stick.

Preparation: Check that Cell seat is free of dirt and debris.

1. Align cell +positive+ side up on seat.
2. Place cell at 20° angle on top of seat with low end towards Audio Jack.
3. Support edge of Main Board and gently press on cell with flat tip of Black Stick until fully seated parallel with Main Board.
4. Check around perimeter for proper seat.

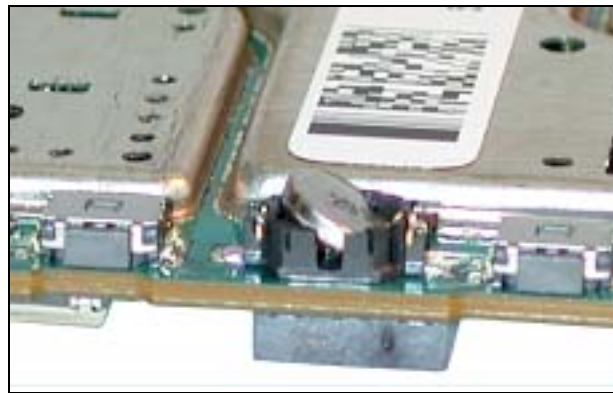

Figure 7-21.

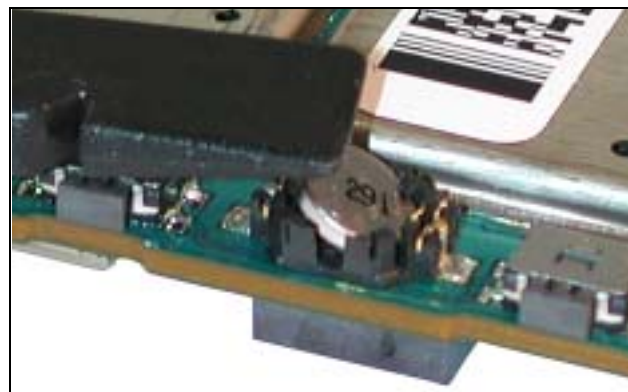

Figure 7-22.

7.6.6 Installing the Main and Controller Boards

Equipment Required: None.

Preparation: Check Front Housing, Main Keypad, and contact areas are clean of dirt and debris.

1. Place Controller Board on top of Main Keypad, maintaining alignment on Front Housing bosses.
2. Press display Flex-Connector onto receptacle on Controller Board.

NOTE: Do not touch Flex contacts with fingers.

3. Align Main Board with housing bosses and connector receptacle on Controller Board.
4. Orbit and gently push Main Board at Audio Jack and unpopulated area until connector is fully seated.



Figure 7-23.

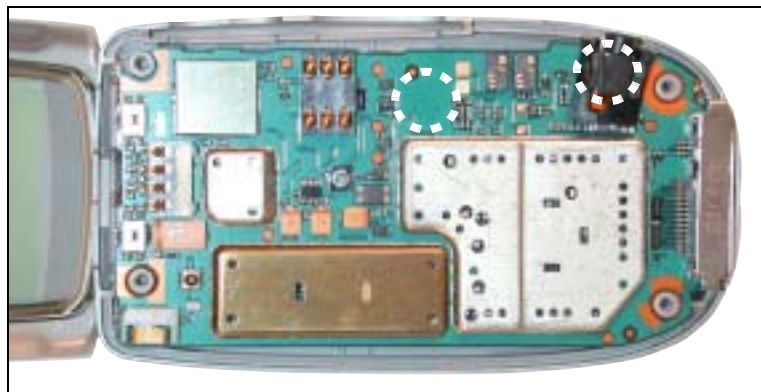

Figure 7-24.

7.6.7 Installing the PTT/Volume Keypad

Equipment Required: None.

Preparation: Check slot for dirt and debris.

1. Align PTT/Volume Keypad with its respective slot in the Front Housing after the Main/Controller Board Assembly is installed (see Figure 7-25).

2. Gently tamp down into place.

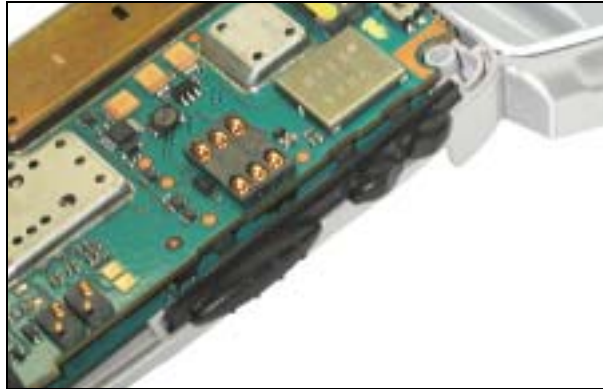

Figure 7-25.

7.6.8 Attaching the Back Housing

Equipment Required: T6 Torx driver, extended tip.

Preparation: None.

1. Align Back Housing on top of Front Housing assembly. Ensure that PTT, Audio Jack Seal, and Display/Mute keypads remain aligned (see Figure 7-26).
2. Insert and torque four T6 screws at 2.5 in.oz.
3. Check housing appearance gap and keypad operation.
4. Insert SIM card and Battery. Perform Model Assembly Test Mode Test (see “Troubleshooting” section).



Figure 7-26.

7.7 Exploded View and Parts List

This section contains the component parts list and exploded view for the *i730* unit.

7.7.1 Component Parts List

Table 7-1. *i730* Component List

#	Description	Part Number	Kit Number
1	Screw, K18	0385273D06	
2	Audio Jack Cover	1585064F01	
3	Back Housing Assembly	1585667E01	
4	Latch Cover	1585856E01	
5	Seal, Back Acoustic	3285547E01	
6	Seas., Audio Jack	3285549E01	
7	Spring, Latch	4185896E01	
8	Label, Batt Floor	5485955E01	
9	Battery Latch	5585562E01	
10	Speaker, Hub Cap	6485569E01	
11	Keypad, Top Button	7585675E01	
12	Front Housing Assembly	1585690E01	
13	Housing Assy, Flip with Display	1585689E01	
14	Screw, T4	0385693E01	
15	Hinge	5585563E01	
16	Housing, Flip Center	1585636E01	
17	Housing Assy Front, w/o Flip	1585944E01	
18	Seal w/Microphone	3285953E01	
19	Microphone	5004153G01	
20	Bumper	7585828E01	
21	Lightguide Call Indicator	6185566E01	
22	Housing, Outer Flip	1585544E01	
23	Hinge, Spindle	5585564E01	
24	Seal, Bottom Connector	3285802E01	
25	Rechargeable Coin Cell, 3V	6087603L01	
26	Keypad, Main	7585576E01	
27	Keypad, PTT/Volume	7585674E01	
28	Antenna	8585081F01	
29	Board, Keypad		NNTN4515A
30	Board, Main		NUF6575A

7.7.2 Exploded View

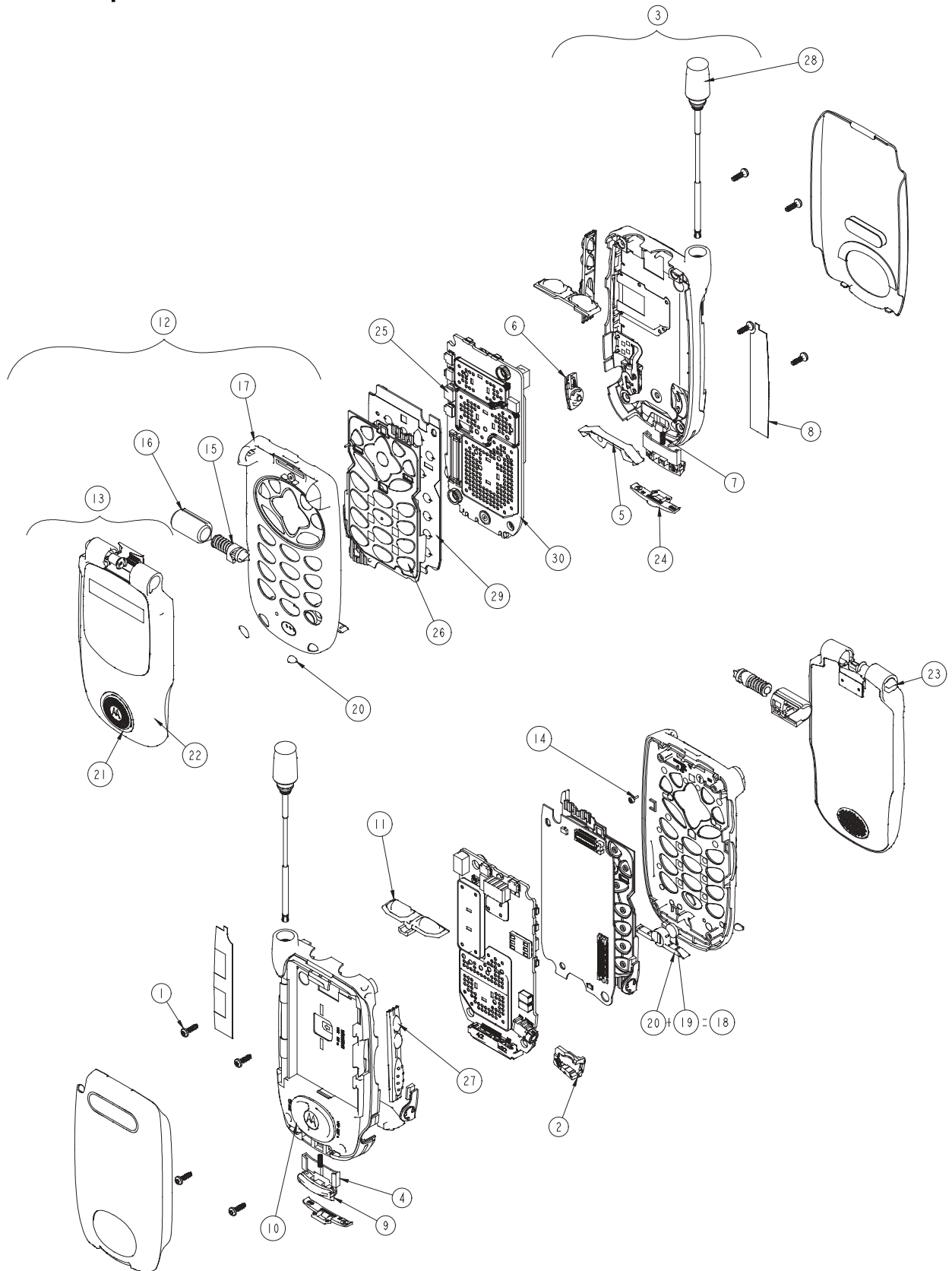

This page intentionally left blank.

CHAPTER 8

FIELD LEVEL TEST MODES AND PROCEDURES

To perform field level testing on the *i730* unit, you must enter a test mode to retrieve data from the unit, and perform the technician tests in the correct sequence with the appropriate equipment.

NOTE: All tests should be performed in an RF interference-free environment.

Test procedures are listed in the order in which they should be implemented. Each test contains a description of what it does and the type of equipment required (if any).

NOTE: The unit must be powered up and registered before performing most tests.

8.1 Test Modes

Some tests require that a certain mode be entered to conduct the test and/or retrieve data from the unit. The following test modes are used with the *i730* unit:

- Engineering debug mode (includes trace mode)
- Test mode

NOTE: Do not enter these modes until unit registration has been completed.

8.1.1 Entering Test Mode

Use this procedure to access test mode.

To enter test mode:

1. Power up the unit. Wait until registration is complete before continuing.

NOTE: Steps 2 through 7 must be performed quickly (no more than one second between each key press).

2. Press **#**.
3. Press *****.
4. Press **Menu** three times.
5. Press the left **Scroll** key.
6. Press **Menu** twice.
7. Press the left **Scroll** key. You now are in test mode.

To exit test mode, press the option key under **Exit**. The unit waits for a few seconds, resets, and then re-registers the unit.

The following tests are performed in test mode:

- TX Power Test
- BER Tests
 - 800BER1
 - 800BER2
 - 800BER3
 - 800BER4
 - 900BER1
 - 900BER2
 - 900BER3

NOTE: The Power, MPX, and MOD test parameters are for factory use only and should not be adjusted by field service personnel. The default values for these parameters are as follows:

- Power: 0 dB
- MPX: 1:6
- MOD: QAM16

8.2 Required Test Equipment

Use the following list to identify the test equipment required to perform the technician tests. Refer to the appendix for test equipment part numbers and descriptions.

- Battery eliminator
- Data cable RS232 or USB data cable
- R-2660 Digital Communications System Analyzer
- RF Adapter
- Variable 5.0 to 12.0 Vdc power supply (3.0 A capability)

8.3 Field-Level Test Checklist

Use the following test checklist to ensure that all the necessary tests are performed and to provide a tracking mechanism in case the unit is sent to the next level of service.

Check the appropriate box for each test performed and indicate whether or not the test was completed successfully.

Table 8-1. Field-Level Test Checklist

Done	Technical Tests	Pass	Fail
	Registration/Call		
	SQE		
	TX Power		
	800BER1 800BER2 800BER3 800BER4 900BER1 900BER2 900BER3		
	Power-Up		
	Keypad		
	Audio		
	Reset		
	Reset Log		
	GPS Receiver		

8.4 Registration/Call Test

Use this test on a unit having any of the following symptoms: No Service failures, Please Wait... Registering failures or red LED lights. (Use a reference unit to get a baseline.)

Note: For 900 MHz verification, please perform the BER Test on page 8-7. May require ordering additional option for test. Contact Motorola Customer Service (see Appendix A).

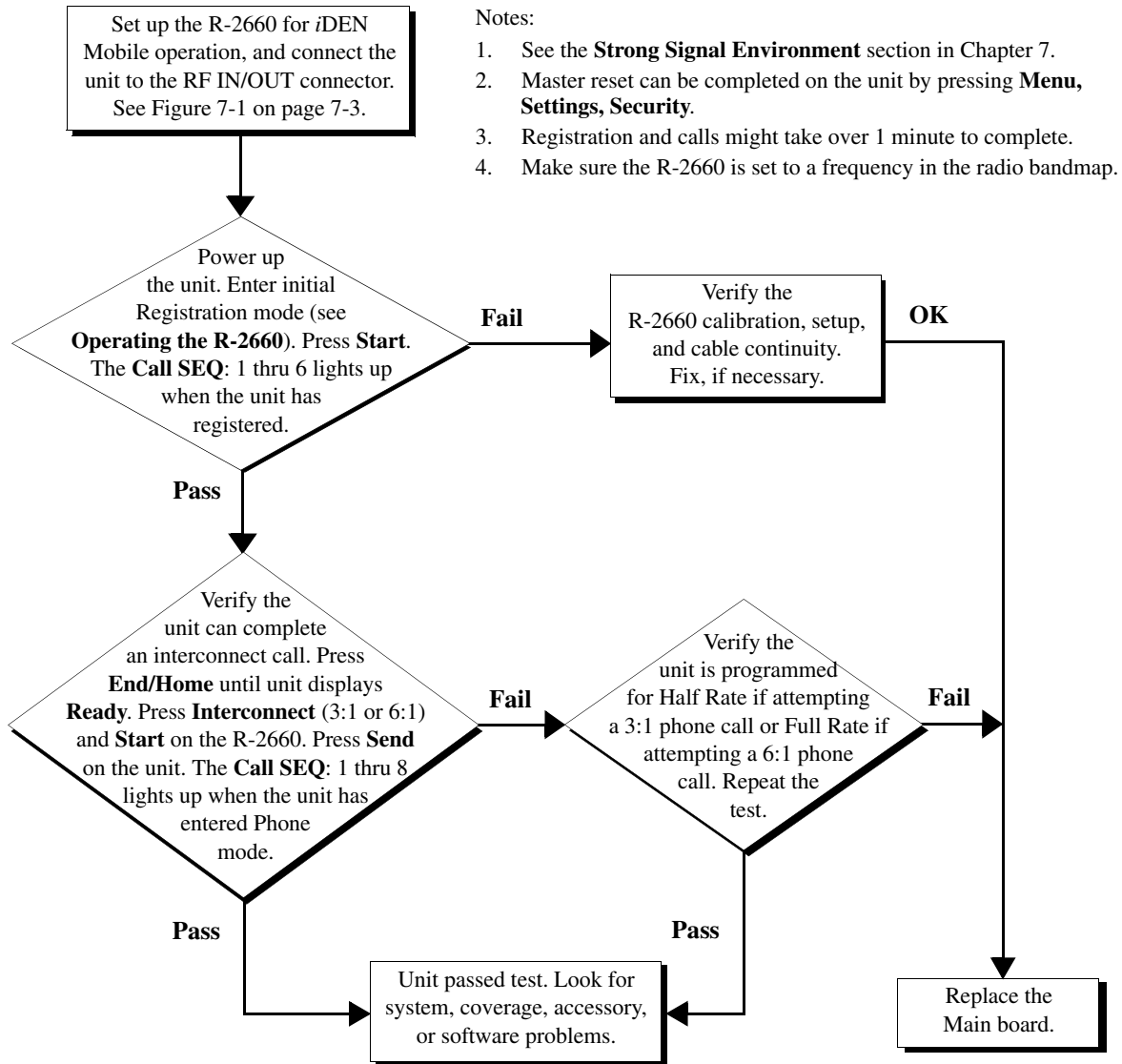

8.5 SQE Test

Use this test on a unit having any of the following symptoms: No service failures or poor SQE/RSSI (poor performance in known good coverage area).

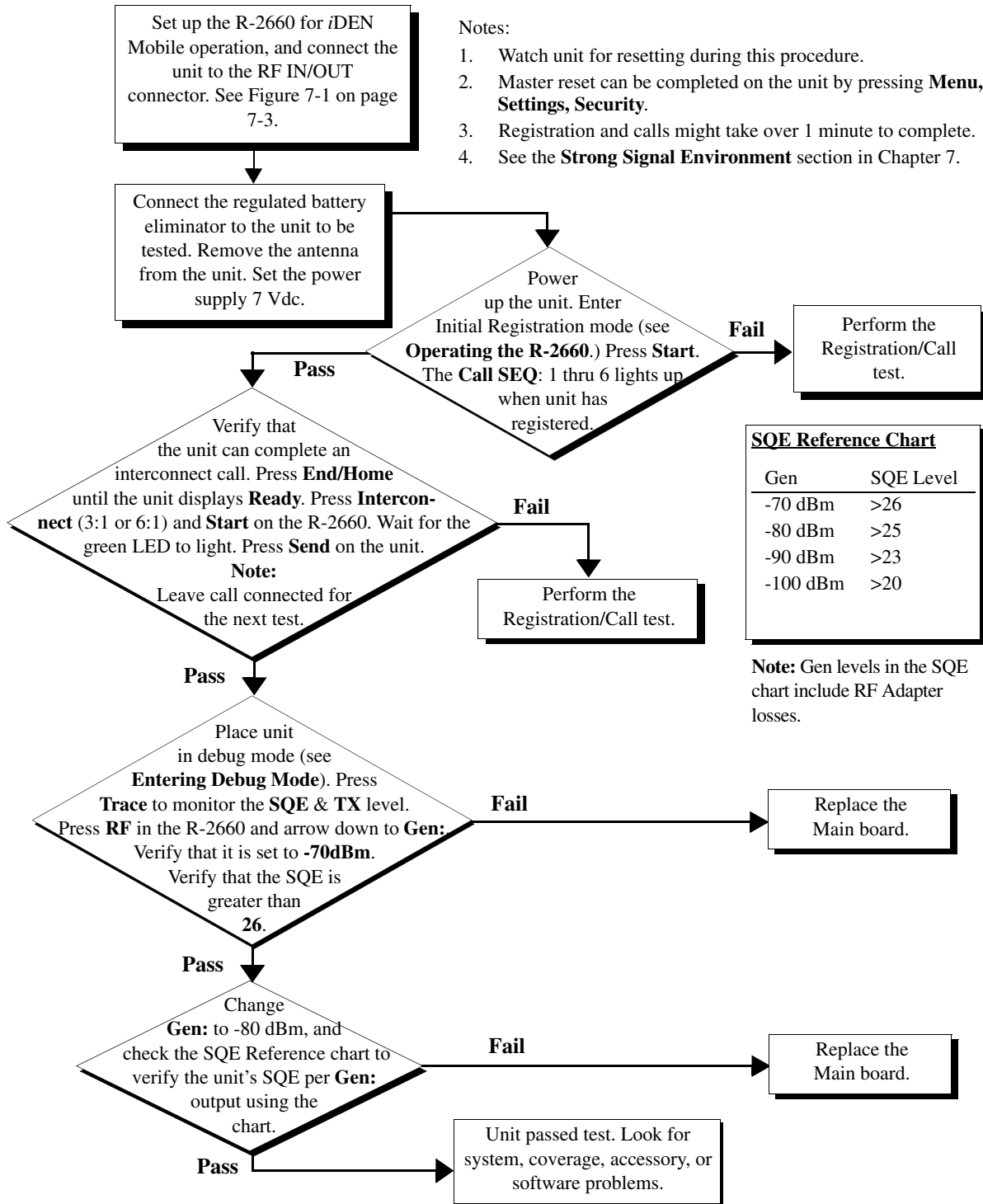

8.6 TX Power Test

Use this test on a unit on a unit having bad transmission (TX) or intermittent service failures. (This is a transmitter test only.)

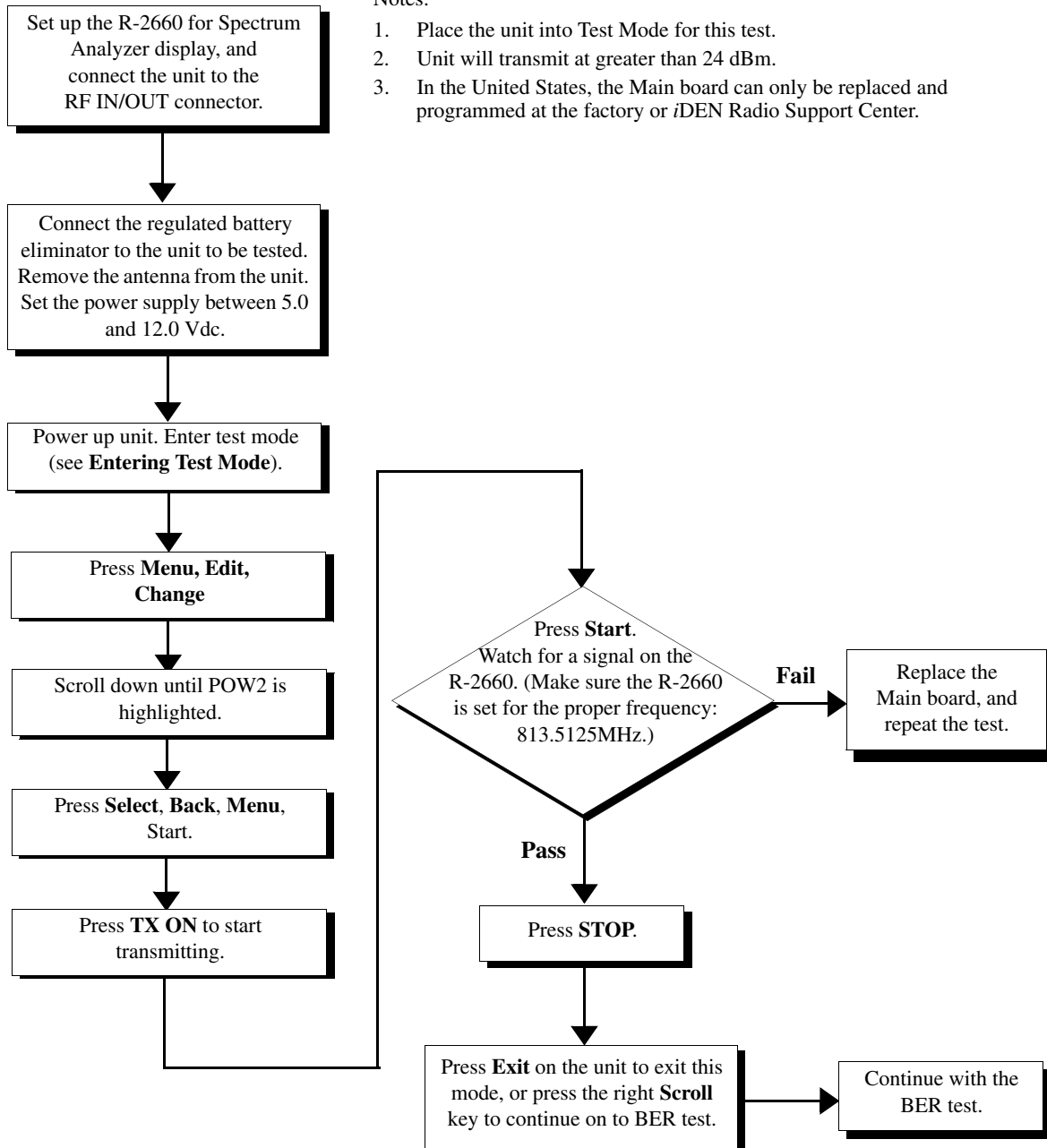

8.7 BER Test

Use this test on a unit having any of the following symptoms: resets (RAAAA Type), No Service failures.

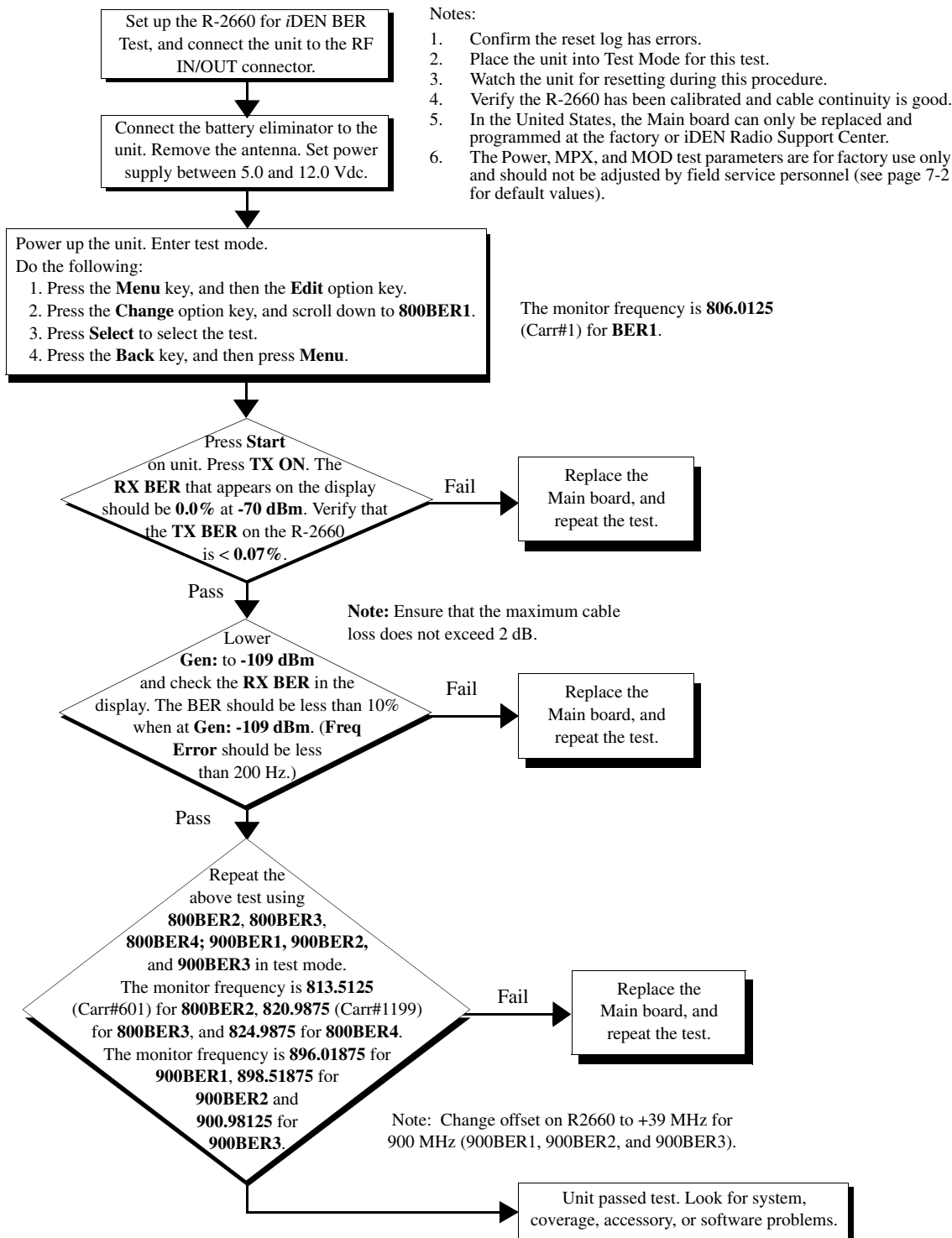

8.8 Power-Up Test

Use this test to check power-up. Symptoms: dead battery, short battery life, or unit does not power up.

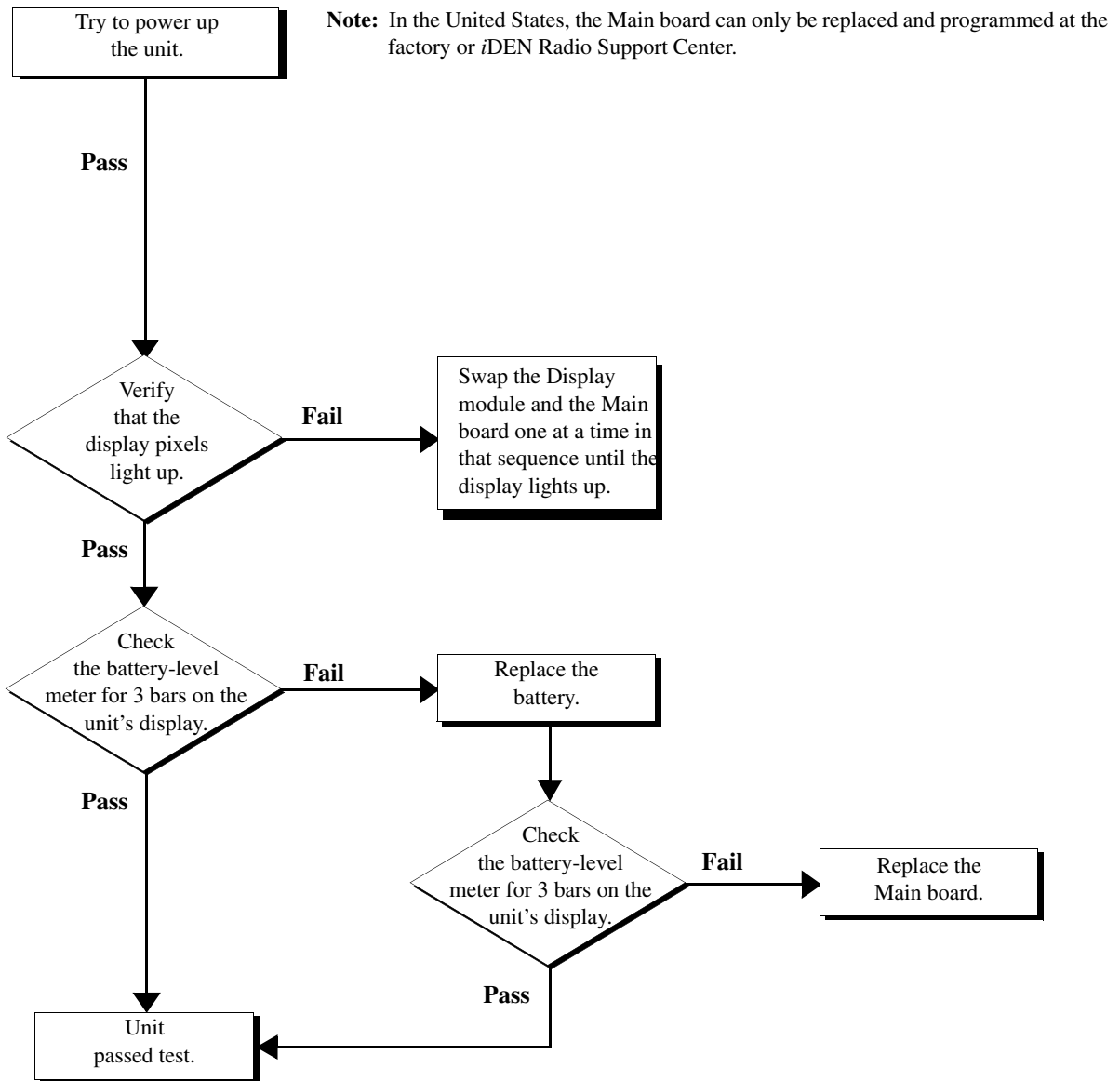

8.9 Keypad Test

Use this test to check the operation of the unit's keypads and display. Symptoms: unit locked, or stuck key

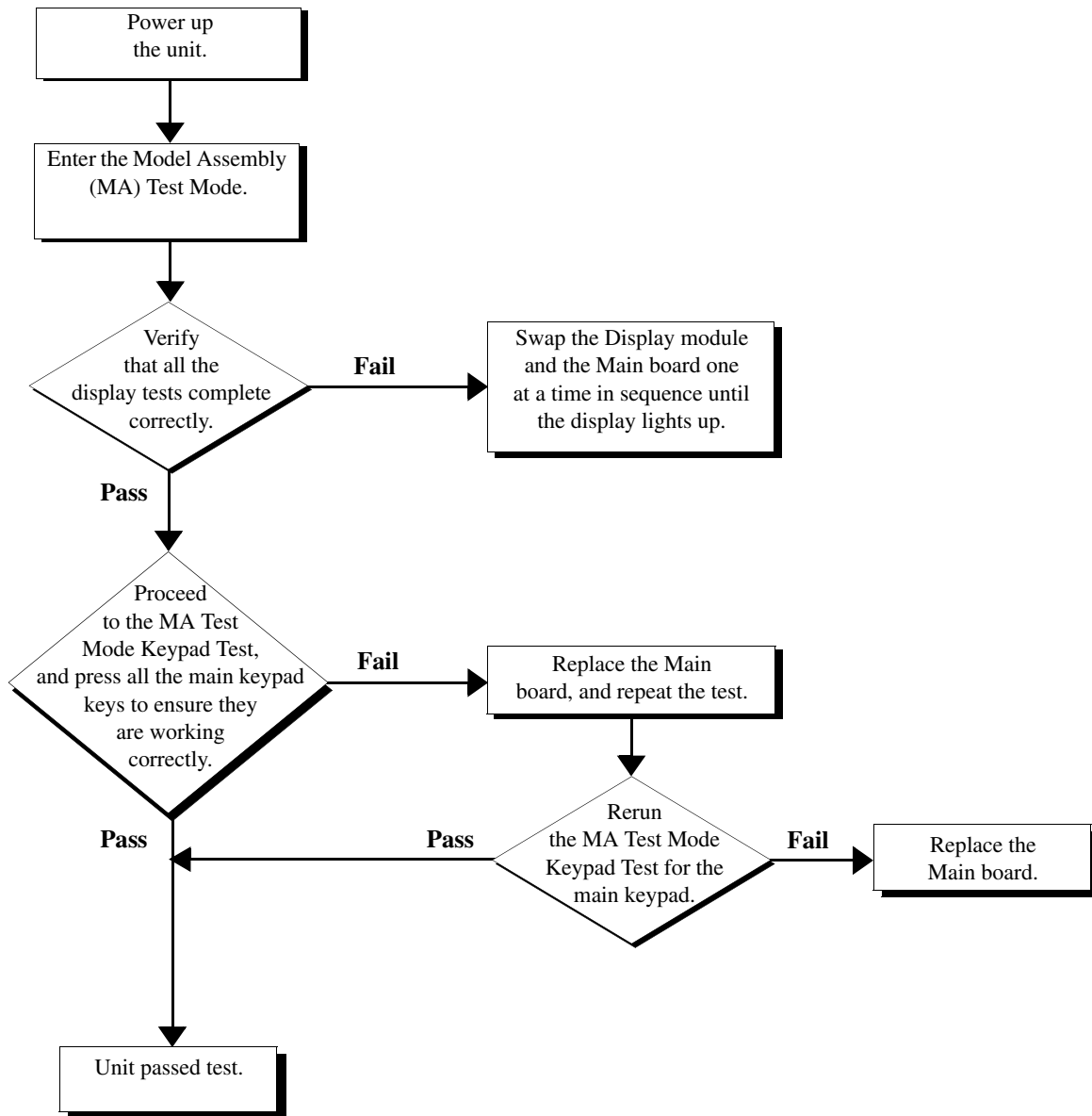

8.10 Audio Test

Use this test to check the audio portion of the unit.

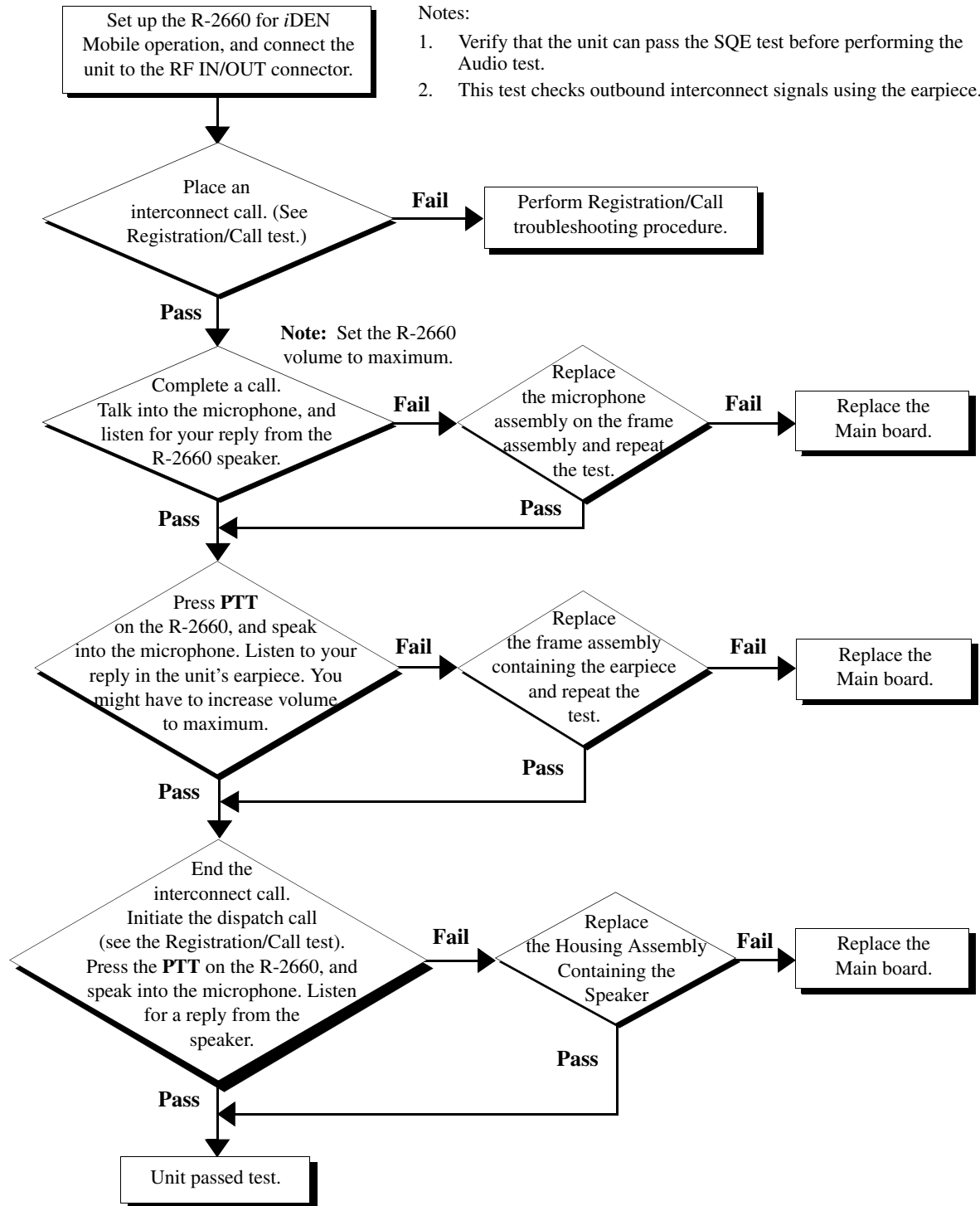

8.11 Reset Test

Use this test on a unit having any of the following symptoms: unit resets, or unit powers off and then on.

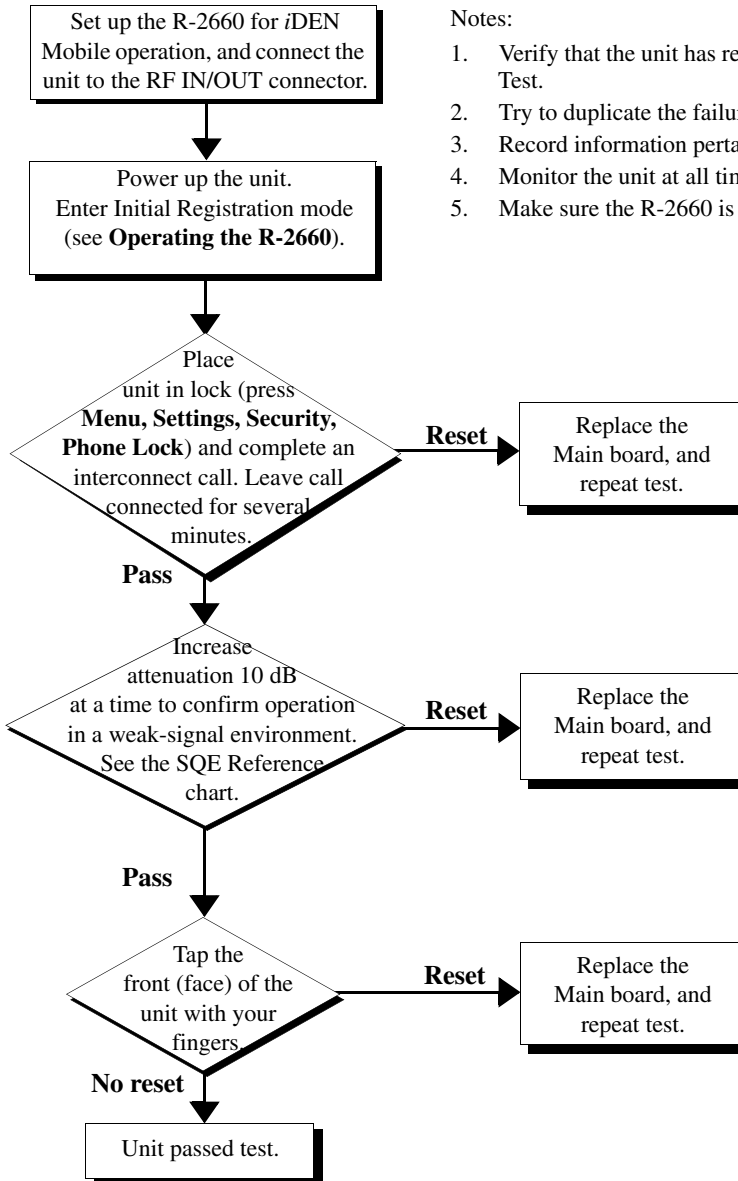

Notes:

1. Verify that the unit has resets entries in the Reset log. See the Reset Log Test.
2. Try to duplicate the failure.
3. Record information pertaining to the failure.
4. Monitor the unit at all times for visual resetting.
5. Make sure the R-2660 is set to a frequency in the unit bandmap.

SQE Reference Chart

Gen	SQE Level
-70 dBm	>26
-80 dBm	>25
-90 dBm	>23
-100 dBm	>20

Note: Gen levels in the SQE chart include RF Adapter losses.

8.12 Reset Log Test

Use this test to check the reset log in the unit.

To perform the reset log test:

1. Power on the unit and wait until registration is complete.
2. If the unit does not have the latest software version, reflash (reprogram) the unit.
If the unit attempts to reset, perform the Reset test (see page 8-11).
3. Enter debug mode (see page 6-1). The **Unit Info** display appears.
4. Scroll down and highlight **Resets**, and then press **View** to view the **Resets** display.
5. Look for and record any reset errors. Refer to the iSB Bulletin for reset classifications.

If the log contains reset errors, perform the Reset test.

6. Place a dispatch call.
7. Look for, and record, any reset errors.

If the unit attempts to reset, perform the Reset test.

8. Place an interconnect call.
9. Look for and record any reset errors.

If the unit attempts to reset, perform the Reset test.

NOTE: If the customer agrees, set the Auto Lock feature. This feature helps detect reset conditions.

8.13 Model Assembly (MA) Test Mode Test

Use this test on a unit to check the functioning of the software.

LCD Test Display

```
LCD Contrast
Calibration:
SAMSUNG
Size 0 128x64
CP Cal = 41
(Room Temp)
Manual:< or >
AutoCal Skip
```

Skip or Manual Calibration OPTION.

LCD Manual

```
LCD Manual
Contrast
Calibration
- < > +
| | | | |-----
Accept?
NO YES
```

Accept manual setting? Right OPTION

Color Bars Test



Any key to advance

All Pixels Test

SCROLL Right

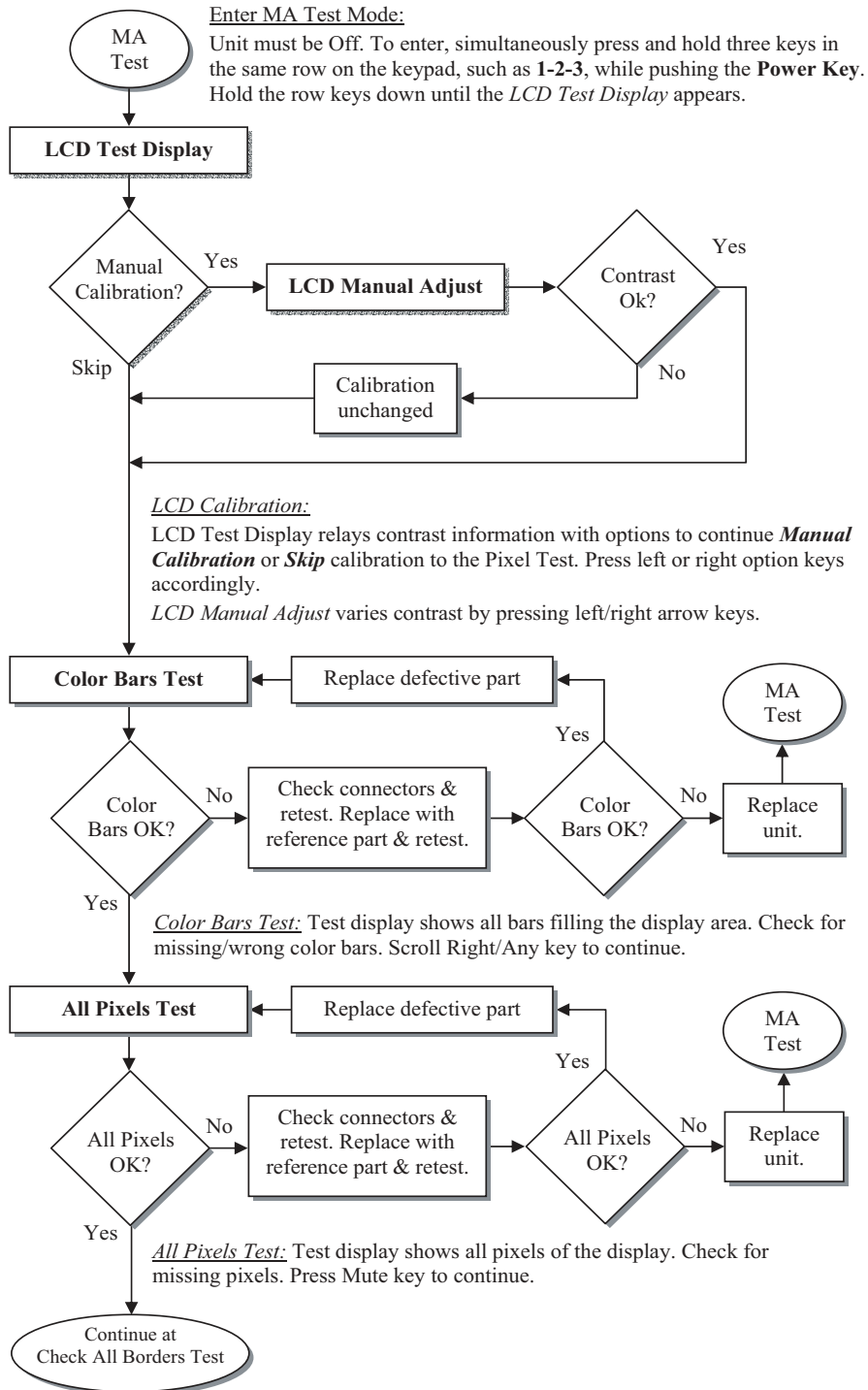

8.13 Model Assembly (MA) Test Mode Test (Continued)

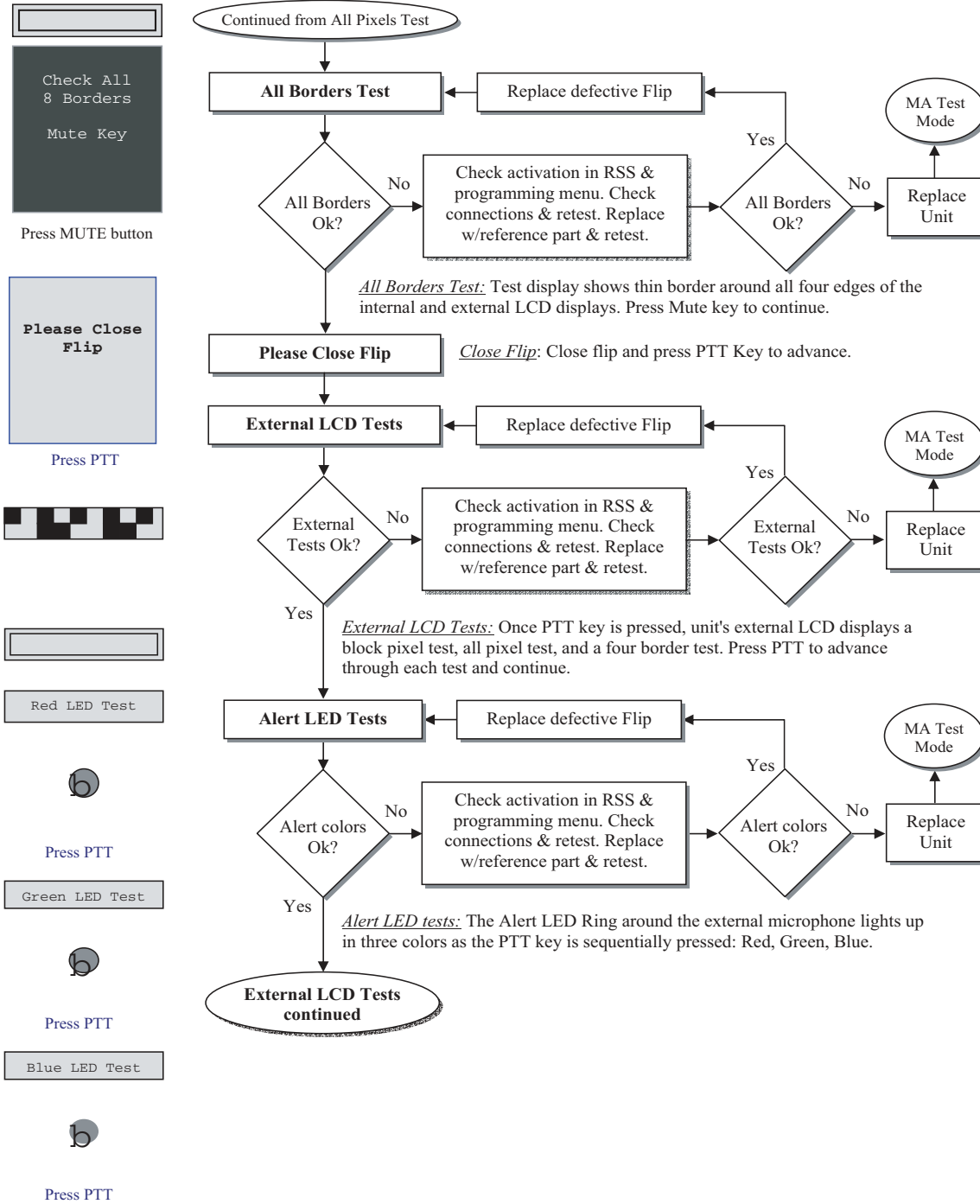

8.13 Model Assembly (MA) Test Mode Test (cont.)

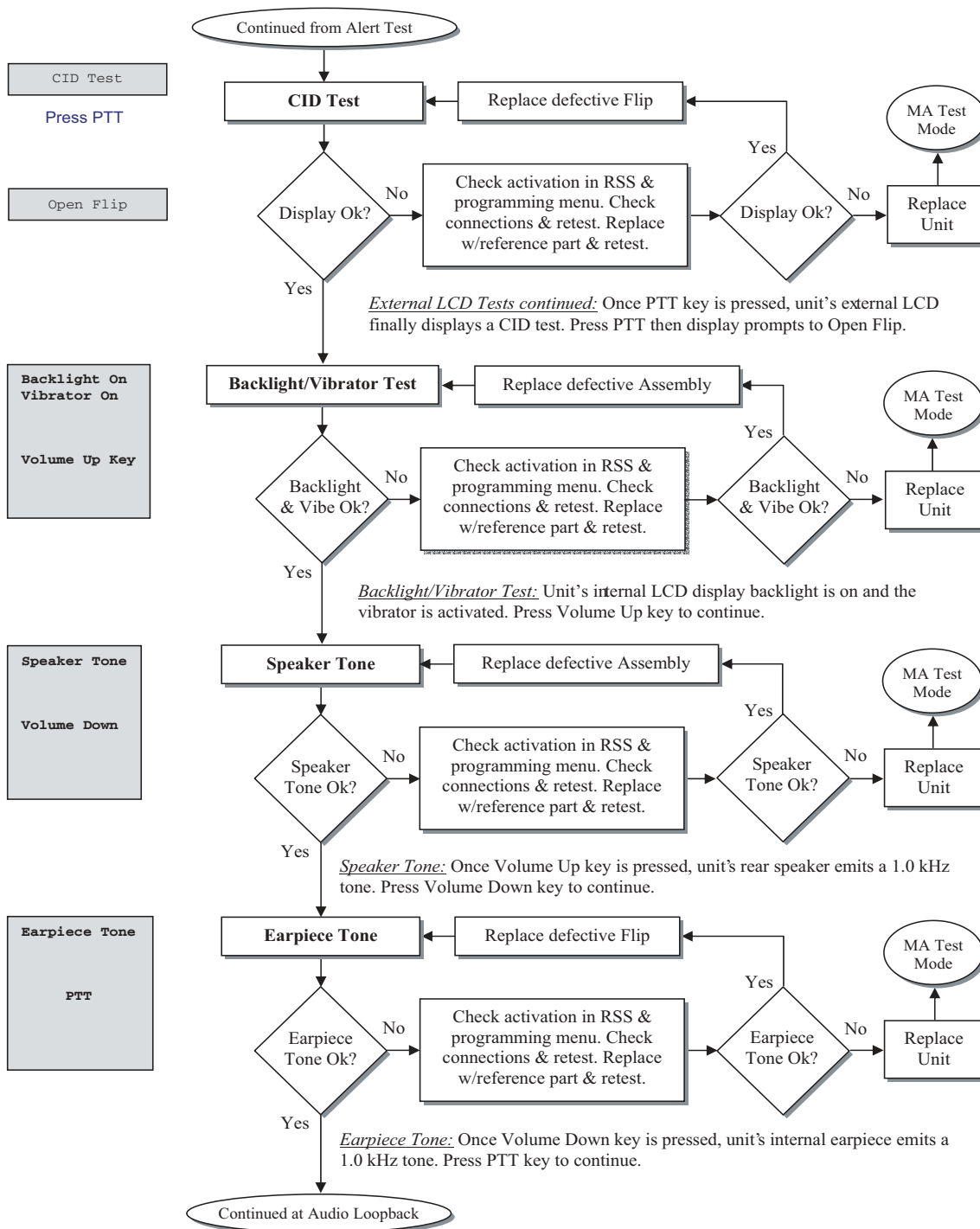

8.13 Model Assembly (MA) Test Mode Test (cont.)

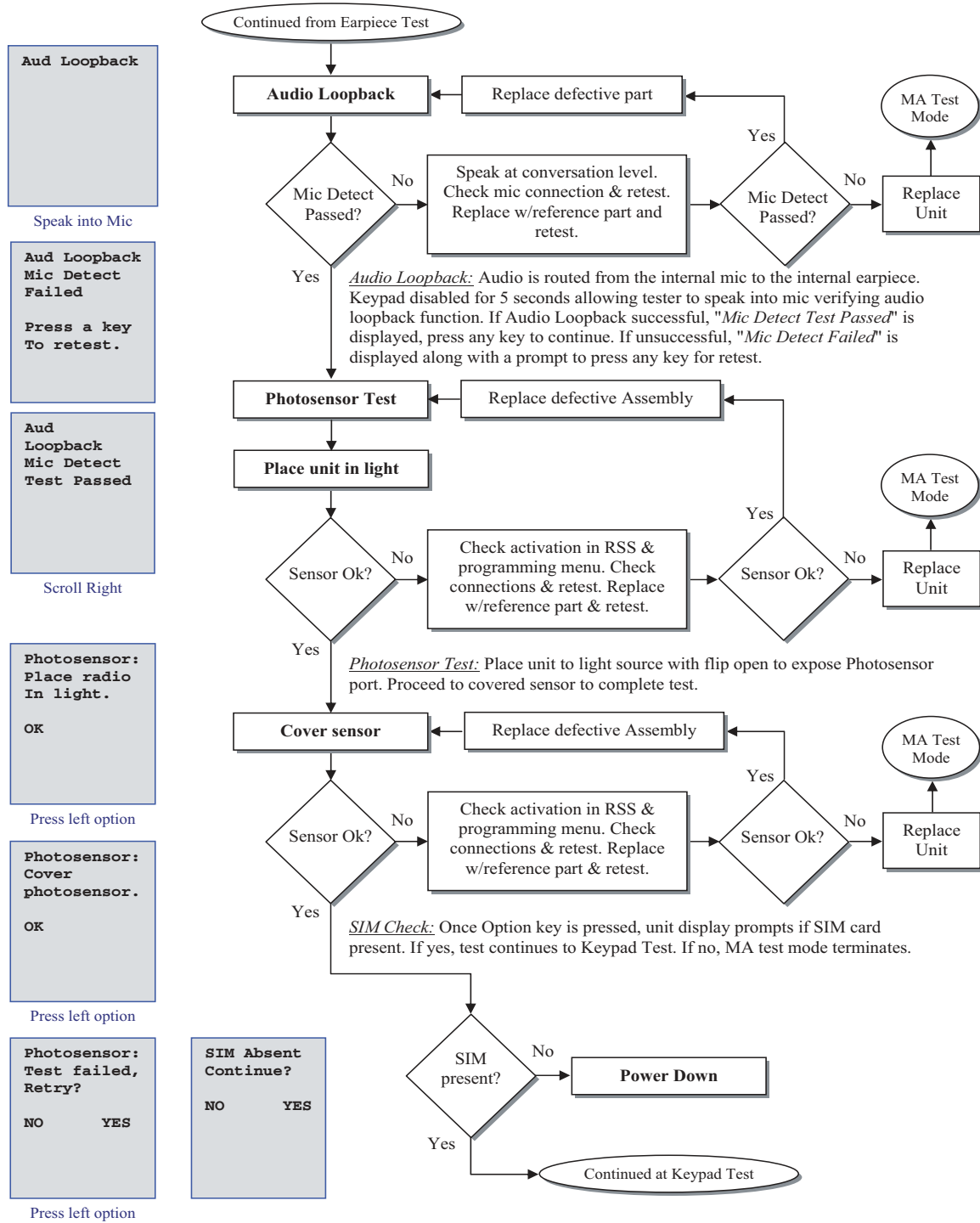

8.13 Model Assembly (MA) Test Mode Test (cont.)

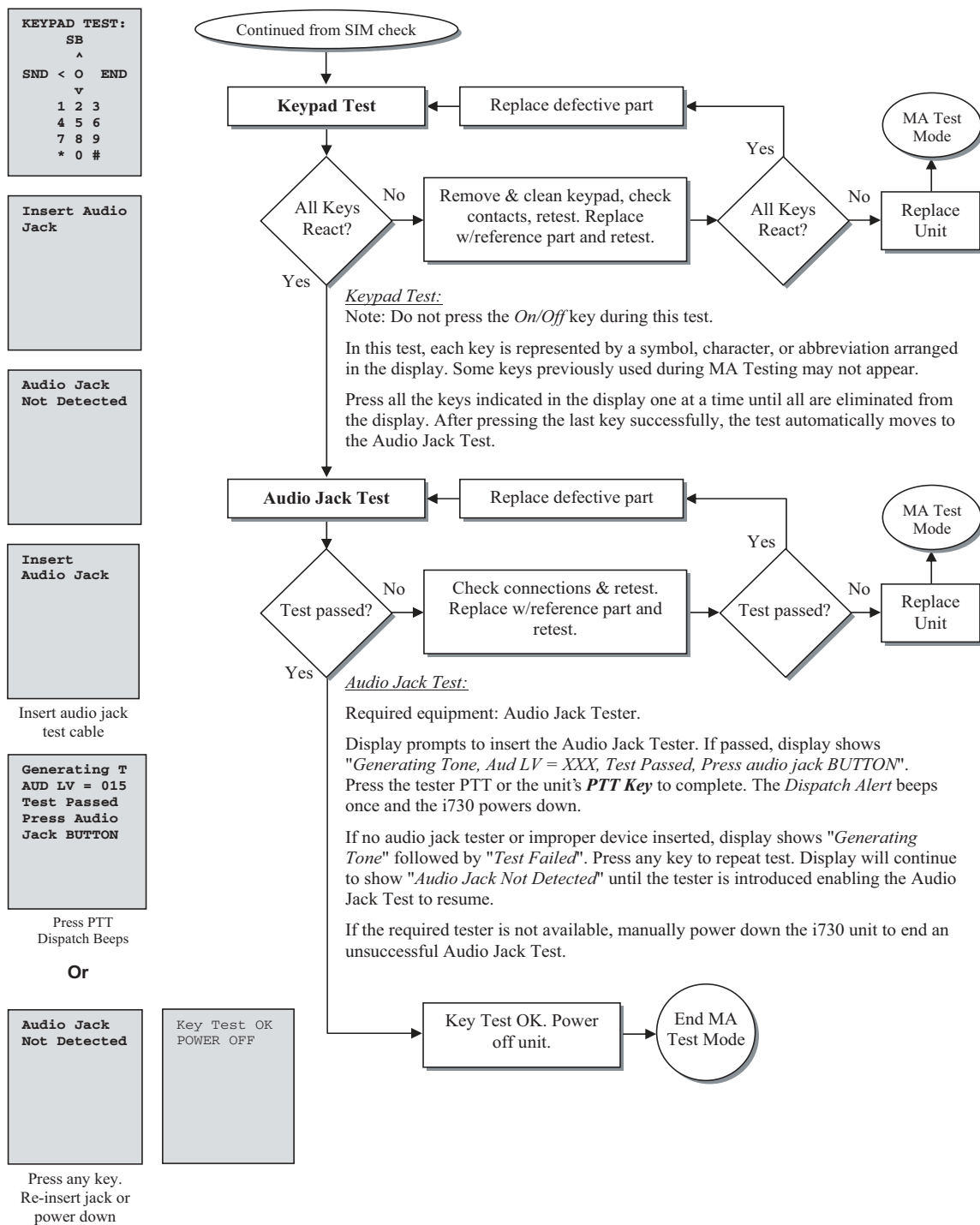

8.14 GPS Receiver

Use this test on a unit to check functionality of the GPS.

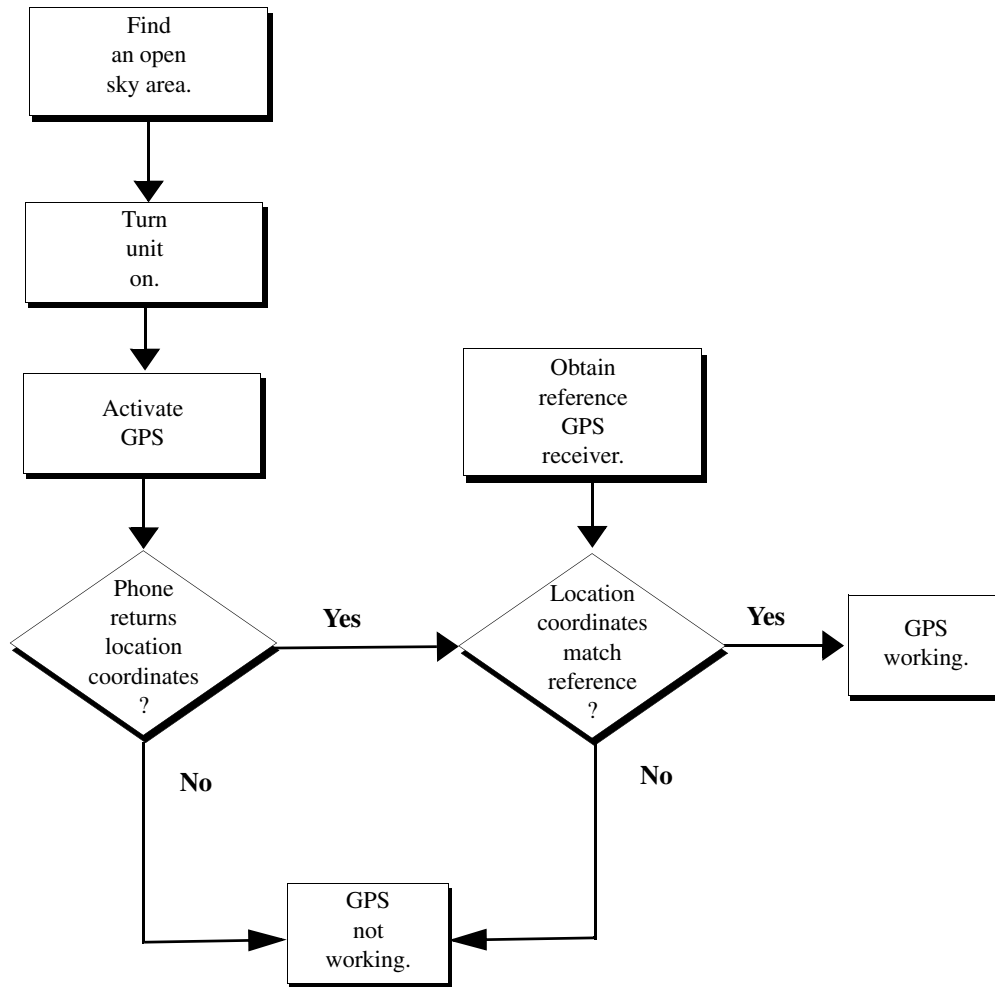

APPENDIX A

ORDERING REPLACEMENT PARTS AND KITS

Parts should be replaced with identical replacement parts. Replacement parts and kits for *i730* units can be ordered directly from the Motorola Accessories and Aftermarket Division (AAD) at 1-800-422-4210 and listen to the prompts; or FAX 800-622-6210.

A.1 Customer Service

For warranty and customer service assistance, call:

1-800-453-0920 U.S./Canada
1-954-723-3000 FAX
1-954-723-4910 International (outside U.S./Canada)

A.2 Replacement Parts

When ordering replacement and accessory parts, the complete part number should be included. If the correct part number cannot be located, call Motorola Parts Identification at 1-800-422-4210.

A.3 Domestic Orders

Send written orders for replacement parts, test equipment, or manuals to:

Motorola, Inc.
Accessories and Aftermarket Division
Attn: Order Processing
1313 E. Algonquin Road
Schaumburg, IL 60196

Call, fax, or telex orders to:
1-800-422-4210
1-847-538-8198 FAX
280127 TELEX

A.4 International Orders

For international orders:

Motorola, Inc.
Accessories and Aftermarket Division
Attn: International Order Processing
1313 E. Algonquin Road
Schaumburg, IL 60196

Call, fax, or telex orders to:

1-847-538-8023

1-847-576-3023 FAX

403305 TELEX

A.5 Replacement and Accessory Parts

The following table lists the replacement and accessory parts and corresponding part numbers that are available for an *i730* unit. Refer to the exploded view and parts list in Chapter 7.

Table A-1. *i730* Replacement and Accessory Parts

Description	Part Number
Accessory Connector	0985678E02
Antenna Assembly	8585081F01
Antenna Bushing Contact	4385816E01
Audio Jack	0985645E01
Back Housing Assembly	1585667E01
Battery Contact	3985471F01
Front Housing Assembly	1585689E07
Keypad, <i>i730</i> English	7585675E01
Keypad, <i>i730</i> PTT/Volume/Speaker	7585674E01
LCD Module	5185409E01
Main Flex Assembly	8485531E01
Microphone Boot	3285551E01
Screw, Housing Assy K18	0385273D03
Seal, Back Acoustic	3285547E01
Seal, <i>i730</i> , Accessory Connector	0985678E02
Seal, <i>i730</i> , Audio Jack	0985645E01
Seal, w/ Microphone	3285953E01
Switch, PTT/VolUp/VolDown	7585674E01

A.6 Replacement Kits

When ordering replacement kits, the complete kit number should be included. If the correct number cannot be located, call Motorola Parts Identification at 1-800-422-4210. Refer to the exploded view and parts list in Chapter 7.

Table A-2. *i730* Replacement Kits

Description	Kit Number
Audio, Privacy Earpiece w/mic	SYN8390
Audio, Earbud w/mic PTT	NNTN4033A
Audio, Hearing Aid Neckloop	SYN7875
Audio, Lightweight Headset	NTN8496
Audio, Over-the-ear Headset w/mic	SYN8146B
Battery, Lithium Ion High Perf (750 mAh)	SNN5705B
Battery, Lithium Ion Slim (600 mAh)	SNN5704
Car Kit, Easy Install	NNTN4744A
Car Kit, Hard Install Base	NNTN4846A
Charger, Mid Rate Travel (Multi-voltage)	NNTN4841A
Charger, Rapid Travel	NNTN4963A
Charger, Vehicular Power Adapter (VPA)	NNTN4679A
Data Cable, RS-232 (Serial Port)	NKN6560
Data Cable, USB	NKN6559
Holster, <i>i730</i>	NNTN4682
Label, <i>i730</i> Escutcheon - Amigo	NTN2053ATEL
Label, <i>i730</i> Escutcheon - Avantel	NTN2053ACOL
Label, <i>i730</i> Escutcheon - DNA/Grid	NTN2053ADNA
Label, <i>i730</i> Escutcheon - IMX	NTN2053APHL
Label, <i>i730</i> Escutcheon - KT/Powertel	NTN2053AKOR
Label, <i>i730</i> Escutcheon - Motorola	NTN2053AMOT
Label, <i>i730</i> Escutcheon - Movilink	NTN2053AMOV
Label, <i>i730</i> Escutcheon - Nextel	NTN2053ANEX
Label, <i>i730</i> Escutcheon - Southern LINC	NTN2053ASOL
Label, <i>i730</i> Escutcheon - Telus	NTN2053ATEL
Plug Converter, Palm III/VII	NKN6546
Plug Converter, Palm V	NKN6547

A.7 Recommended Test Equipment and Tools

The following table lists the standard test equipment recommended for troubleshooting *i730* units at the field level of service.

Table A-3. Recommended Test Equipment and Tools

Description	Part Number
Battery Eliminator	NNTN4850A
Black Stick	SLN7223A
Cable, Audio Jack Test	NNTN5175A
Cable, SMA to N-Type RF	Contact Motorola
Communications System Analyzer	Motorola R-2660
Data Cable, RS-232 (Serial Port)	NKN6560
Data Cable, USB	NKN6559
Digital Volt-Ohm Meter	Keithly 2001 or eq.
Pliers, Needlenose	6680384A33
Power Supply, 0-15VDC, 0-3A	S1348D
Radio Service Software	R01.16.02
Screwdriver, mini flat-tipped, 1/8	6680343A25
SIM Card, Reference	NTN9208
Torx Bit, T-6	6680387A70
Torx Driver, calibrated	RSX4043
Wrist Strap, Static ground	NTN9812

A.8 Recommended Programming Equipment

The following tables list the programming equipment and software recommended for troubleshooting *i730* units at the field level of service.

Table A-4. Recommended Programming Equipment

Name	Part Number	Description
Cable, Data, RS232 Cable, Data, USB	NKN6560 NKN6559	Connects unit directly to the computer for programming the codeplug and subscriber code
Cable, Data (2.5mm)	TTY	Connects unit to a teletypewriter (TTY) device for making phone calls.

Table A-4. Recommended Programming Equipment (Continued)

Cable, Data (for GPS interface)	GPS	Connects unit to a laptop or other device for sending location information.
Computer, IBM PC-Compatible (RSS Workstation)	N/A	Pentium microprocessor with: 32MB RAM min.; 4MB hard disk space min.; Two serial ports and one parallel port; network-capability; Microsoft Windows 2000, Windows 98, or Windows NT 3.5.1 or later

Table A-5. Recommended Software

Name	Part Number	Description
Radio Service Software (RSS) Carrier Version Super Agent Version	RVN4121 RVN4122	Programs the unit
<i>i</i> DEN CompanionPro		Allows “Contacts” information stored on an <i>i</i> 730 unit’s SIM card to be used with an <i>i</i> 2000, <i>i</i> 2000 <i>plus</i> , or any other GSM phone.
<i>i</i> DEN Wireless Data Services Software		Programs a laptop, handheld device, or desktop computer to use the <i>i</i> 730 unit as a modem to transfer circuit or packet data.
Interactive Map Software (such as that made by DeLorme or Microsoft) that supports NEMA 3.0 format		Allows <i>i</i> 730 unit’s GPS feature to provide approximate location data to a laptop computer or other device.

GLOSSARY

The terms and definitions that follow apply to a range of *iDEN* products, including the i-Series, m-Series, r-Series, and L-Series units.

Accur	Value used by the GPS chipset that is calculated upon a time request.
A/D	Analog to digital converter.
antenna	Device that permits radiation and reception of radio frequency into space.
ASIC	Application Specific Integrated Circuit.
Automatic Retry	Feature that redials the last number entered.
band	Frequencies allowed for a specific purpose.
base station	Radio located at the fixed (base) location in two-way radio communications.
battery	Electrochemical storage cells that serve as a DC voltage source.
BCCH	Broadcast control channel.
BER	Bit error rate.
BERT	Bit error rate test.
bps	Bits per second.
busy indicator	Green LED that lights when the channel is busy. See <i>LED</i> .
cable	One or more insulated wires that conduct electrical current.
Call Alert	Feature that indicates through horn blasts or lights flashing that a call has come in.
call letters	FCC-assigned ID letters and numbers for two-way radio stations.
CCCH	Common control channels used to control paging and grant access.
CDMA	Code Division Multiple Access.

channel	Narrow band within which a radio operates to prevent interference with stations on adjacent channels. See also <i>band</i> .
circuit data	A wireless modem connection that uses the unit and a data cable to send and receive faxes.
CMOS	Complimentary metal-oxide semiconductor.
CODEC	Coder/decoder.
codeplug	Firmware that contains the unique personality for a system or device. A codeplug is programmable and allows changes to system or unit parameters. See also <i>firmware</i> .
CODEX	Manufacturer of modems for Motorola's Internet Networking Group.
color code	In cellular technology, a coding method for differentiating between two or more cells using the same frequency.
console	Cabinet that houses equipment and controls for a communications center.
D/A	Digital-to-analog converter.
DCCH	Dedicated control channel.
decoding	Signal detection and audio passing based on this detection. See also <i>encoding</i> and <i>decryption</i> .
decryption	Unscrambles encoded voice/audio signals into recognizable and audible voice.
default	Pre-defined set of parameters.
demodulation	Extracting the audio frequency signal from the modulated carrier signal. See also <i>decoding</i> and <i>encryption</i> .
desk set	Telephone-like, radio-control device that includes a microphone, speaker, frequency selector, and code selector.
digital	Data in pulse form.
DSP	Digital Signal Processor.
DST:1	Indication that Daylight Savings is in effect

encryption	Scrambles voice input or audio signals into encoded signals before routing to the transmitter for broadcast. See also <i>decryption</i> .
Epoch	Value that is provided by the network that helps the subscriber to calculate GPS time.
Epoch 1/2	Value that describes whether the Epoch is in the first or second half. This value is used to detect latency.
ESN	Equipment serial number.
FCC	Federal Communications Commission.
firmware	Software or software/hardware combination of computer programs and data with a fixed logic configuration stored in read-only memory.
fleet	Units working in a group.
FDMA	Frequency Division Multiple Access.
Frame	Frame value that was used in the most recent time request.
frequency	Number of times a complete electromagnetic-wave cycle occurs in a fixed unit of time (usually 1 second). See also <i>radio frequency (RF)</i> .
GMSK	Gaussian minimum shift keying.
GMT	Greenwich Mean Time
GPS	Global Positioning System
GSM	Global system for mobile communications.
Gtow	GPS TOW or the seconds into the GPS week that is reported as part of the GPS time.
Gwk	GPS week that is reported as part of the GPS time.
hardware	Physical components of a system, such as boards and cables.
Hertz (Hz)	Basic measure of frequency. An electromagnetic wave completes a full cycle from positive to negative pole and back again; each unit is equal to 1 cycle per second.

HLR	Home location register.
IC	Integrated circuit.
ICC	iDEN Customer Care Center.
IF	Intermediate frequency.
IMEI	International mobile equipment identifier.
IMSI	International mobile station identifier.
interconnect	Ability to transmit RF-originated messages through the telephone system.
interleave	Rate at which transmit or received slots are available for communication.
ISDN	Integrated services digital network.
kilohertz (kHz)	Unit of frequency equal to 1000 Hertz. See <i>Hertz (Hz)</i> .
LCD	Liquid crystal display.
Leap Sec	Number of leap seconds between GMT and GPS time (needed to calculate the time).
LED	Light-emitting diode.
line-of-sight transmission	RF energy that is radiated in a direct path from the transmitting antenna to the receiving antenna. See also <i>radio frequency (RF)</i> .
local control	Control of a base station that is physically near the dispatcher. See also <i>remote control</i> .
megahertz (MHz)	Unit of frequency equal to 1 million Hertz. See <i>Hertz (Hz)</i> .
mobile	Two-way radio equipment designed for vehicular installation.
modem	MOdulator/DEModulator device usually connecting a computer to a communication line.
modulator	Transmitter component that superimposes voice information or other data onto an RF carrier.

MS	Mobile Subscriber.
NAM	Number Assignment Module.
NMEA	National Marine Electronics Association.
ODCT	Offset Direct Conversion Transmitter.
OE	Output enable.
PA	Power amplifier.
packet data	A wireless modem connection that uses the unit as a modem to access the Internet and send and receive e-mail.
paging	One-way communication that alerts the receiver to receive a message.
PCCH	Primary control channel.
PCM	See <i>Pulse Code Modulation (PCM)</i> .
PIT	Programmable interrupt timer.
PLMN	Public land mobile network.
point-to-point communications	Radio communication between two fixed-location radio stations. See also <i>base station</i> .
power source	Transforms standard AC current to well-filtered and regulated DC current.
power-up	Process whereby the unit is turned on, self-tests are performed, and registration is completed.
power-up alert tones	Tones that indicate the unit is powering up.
Private Conversation	Feature that allows one unit to privately talk to another unit within a fleet. See also <i>fleet</i> .
PSTN	Public switched telephone network.
PTT	See <i>Push-to-Talk (PTT)</i> .

PUK	Pin unblocking key.
Pulse Code Modulation (PCM)	Type of pulse modulation in which a code is used to represent quantized values of instantaneous samples of the signal wave.
Push-to-Talk (PTT)	Activates the transmitter so that a message can be sent. This operation is performed by pressing and holding the PTT key while sending the message.
QAM	Quadrature amplitude modulation.
radio frequency (RF)	Portion of the frequency spectrum between audio sound and infrared light (10 Hz - 10 GHz).
radio receiver	Device that amplifies RF signals. This device separates the audio signal from the RF carrier, amplifies it, and converts it back to the original sound waves.
radio wave	Combination of electric and magnetic fields with varying radio frequencies that are capable of traveling through space at the speed of light.
RAM	Random access memory.
RCE	RISC control engine.
remote control	Control of a system whose functions are performed more than 100 ft. from the base station. See also <i>local control</i> .
repeater	Radio station that automatically rebroadcasts received radio signals.
RF	See <i>radio frequency (RF)</i> .
RISC	Reduced instruction-set computer.
ROM	Read only memory.
ROS/VRIS	Radio Operating System/Virtual Radio Interface Standard.
RSS	Radio Service Software.
RSSI	Received Signal Strength Indicator.
RTE	Real-time clock.

RX	Receive.
signal	Electronically transmitted electromagnetic wave.
SIM	Subscriber identity module.
Slot	Slot value used in the most recent time request.
SMR	Specialized mobile radio.
spectrum	Frequency range within which radiation has specific characteristics.
SQE	Signal quality estimator.
squench	Electronic circuitry that is added to the transmitter and receiver of a radio to reduce unwanted signals before they are heard through the speaker.
SRAM	Static RAM chip used for volatile, program/data memory. See also <i>RAM</i> .
static noise	Noise heard in a receiver due to atmospheric changes in electrical charges.
TAB	Technical application bulletin.
TDD	Time Division Duplex.
TDM	Time Division Multiplexing.
TDMA	See <i>Time Division Multiple Access</i> .
TIB	Technical information bulletin.
time advance	Technology that notifies the unit when the propagation delay between itself and the base station is sufficient to adversely affect data transfer. The unit automatically adjusts for the delay. Propagation delay increases with distance between the unit and its base station.
Time Division Multiple Access	Digital transmission standard that allows multiple users to share the same communications path. Transmissions are limited to a specific time slot.
tower	Antenna-supporting structure.

transmitter	Equipment that generates and amplifies an RF carrier signal, modulates the signal, and then radiates it into space.
TX	Transmit.
Tz	Indicates how far a subscriber is from GMT time—the time is 5 hours behind GMT.
UART	Universal Asynchronous Receiver Transmitter.
unit	Two-way radio, hand-held phone, or mobile.
unit-to-unit	Two-way radio conversation that is not routed through a base station.
vco	Voltage-controlled oscillator.
Vector Sum Excited Linear Predictive (VSELP)	Technique that digitally codes and significantly compresses voice signals, increasing radio channel capacity by reducing the amount of information that needs to be transmitted.
VLR	Visitor location register.
VOCODER	Voice-processing technique that converts spoken language into digital information (voice + coder).
VSELP	See <i>Vector Sum Excited Linear Predictive (VSELP)</i> .
XCDR	Transcoder that converts VSELP to and/or from Pulse Code Modulation (PCM). See also <i>Pulse Code Modulation (PCM)</i> .

INDEX

A

- accessories A-2
 - reference 4-5
- Accessory Swap test 5-4
- alert tones 3-4
- allocating time 1-2
- altering RF signals 1-1, 1-2
- antenna considerations 5-1
- Audio Loopback test 6-4
- Audio test 8-10

B

- bands
 - primary 6-3
 - secondary 6-3
- base station 1-4
- basic test procedures 6-1
- basic-level test
 - checklist 5-2
- Battery Connections test 5-5
- BCCH
 - See broadcast control channel
- BER test, RX 8-7
- bit stream 1-3
- broadcast control channel (BCCH) 1-4
- bursts, RF transmission 1-3

C

- cables, checking 7-1
- calibrating test equipment 7-1
- Call Performance test 5-12
- calling area coverage 1-4
- channel modes
 - dual band 1-4
- channels, voice 1-4
- checklist, basic-level test 5-2
- checklist, field-level test 8-2
- checks, mechanical 5-3
- cleaning a unit 5-2
- Codeplug Repair procedure 6-9
- codeplug troubleshooting 6-10
- coding technique 1-3
- Communications System Analyzer
 - See R-2660
- compression, voice 1-3

- conditions, test 5-1
- connecting to RSS workstation 6-8
- conventions, manual xiv
- Corrupted Software Repair procedure 6-10
- Customer Care, contacting 5-1
- customer service, contacting A-1

D

- debug mode 6-1
- digital
 - bit stream 1-3
 - modulation 1-1
- dispatch mode 1-4
- displays
 - icons 1-3
 - LED indicators 1-3
 - power-up 3-1
 - testing mode 6-2

E

- Engineering Debug check 6-5
- environment, strong-signal 7-1
- equipment, recommended
 - programming equipment A-7
 - test A-6
- error
 - self-test non-reset 3-2
 - self-test reset 3-2
- ESN and IMEI Matching test 6-5

F

- field level
 - test modes and procedures 8-1
- field-level test
 - checklist 8-2
- Flash test 6-10
- frequency range, unit 1-1
- function, vibrator 3-7

G

- glossary
 - terms and definitions G-1

H

- handoff 1-4

I

- indicators
 - display 1-3
- Initial Registration mode 7-4
- interconnect mode 1-4

K

- Keypad test 8-9
- kits
 - ordering A-1
 - replacement A-4

L

- Lockup test 5-4

M

- mechanical checks
 - Accessory Swap 5-4
 - Audio Loopback 6-4
 - basic 5-1
 - Battery Connections 5-5
 - Lockup 5-4
 - Shock and Pressure 5-3
 - Voltage Recognition 5-6
- menu settings 5-7
- messages, service 3-3
- mode
 - debug 6-1
 - dispatch 1-4
 - Initial Registration 7-4
 - interconnect 1-4
 - test 6-1, 6-3, 8-1
- model
 - numbering system vii
 - specifications viii
- Model Assembly (MA) Test Mode Test 8-13, 8-14
- model information vii
- modes
 - 800 MHz 1-4
 - 900 MHz 1-4
 - QAM 1-1
 - QPSK 1-2
- modes of operation 1-1
- modulation
 - digital 1-1
 - QPSK 1-2
 - Quadrature Amplitude 1-1

N

- numbering system, model 1-vii

O

- Omni station 1-4
- operating the R-2660 7-4

- ordering replacement kits and parts A-1
- overview, iDEN technology 1-1

P

- pages 1-4
 - parts
 - accessories A-2
 - ordering A-1
 - replacement A-2
 - Passcode test 5-7
 - PCCH
 - See primary control channel
 - power-down sequence 3-2
 - power-up sequence 3-1
 - Power-Up test 8-8
 - preventive maintenance 5-2
 - primary control channel (PCCH) 1-4
 - procedures
 - See tests
 - programming
 - unit 6-8
 - programming equipment
 - recommended A-7
 - RSS A-7
 - RSS workstation A-7
 - Programming Menu Settings Check 5-7
 - Public Switch Telephone Network (PSTN) 1-4
 - publications, related xiv
- Q**
- QAM
 - See Quadrature Amplitude Modulation
 - QPSK
 - See Quadrature Phase Shift Keying
 - Quadrature Amplitude Modulation
 - modes 1-1
 - signal spectrum 1-2
 - technique 1-1
 - Quadrature Phase Shift Keying, technique 1-2
 - QuickComm feature 6-9
- R**
- R-2660
 - operating 7-4
 - user's manual xiv
 - using RSS 7-2
 - radio frequency
 - See RF
 - Radio Service Software
 - See RSS
 - Radio Service Software (RSS) 6-8
 - reference
 - accessories 4-5
 - unit 4-5

- registration mode 7-4
 - Registration/Call test 8-4
 - related publications xiv
 - repetition rate 1-4
 - replacement
 - kits A-4
 - parts A-2
 - replacement parts
 - domestic orders A-1
 - international orders A-2
 - listing A-2
 - reset condition 5-1
 - reset errors 3-2
 - Reset Log test 8-12
 - Reset test 8-11
 - RF
 - allocation 1-2
 - altering signals 1-1, 1-2
 - checking cables 7-1
 - transmission bursts 1-3
 - RSS
 - QuickComm feature 6-9
 - See Radio Service Software
 - user's guide xiv
 - using 7-2
 - version A-7
 - workstation A-7
 - RSS workstation
 - connecting to 6-8
- S**
- safety information iii
 - Sectored station 1-4
 - SELF CHECK ERROR 3-2
 - SELF CHECK FAIL 3-2, 6-10
 - self-test
 - non-reset errors 3-2
 - reset errors 3-2
 - self-test procedures
 - basic 5-1
 - Call Performance 5-12
 - ESN and IMEI Matching 6-5
 - Passcode 5-7
 - Programming Menu Settings Check 5-7
 - service
 - messages 3-3
 - service, customer A-1
 - settings, menu 5-7
 - Shock and Pressure test 5-3
 - signal spectrum, Quadrature Amplitude Modulation 1-2
 - signal, altering RF 1-1, 1-2
 - SIM card
 - purpose 1-5
 - replacing 1-6
 - test 4-5
 - SIM Card Swap Test 5-3
 - slot number 1-3
 - specifications, model viii
 - SQE Test 8-5
 - static-sensitive devices, protecting 7-1
 - strong-signal environments 7-1
- T**
- TDMA
 - See Time Division Multiple Access
 - technician tests
 - Audio 8-10
 - Codeplug Repair Procedure 6-9
 - Codeplug Troubleshooting 6-10
 - Corrupted Software Repair Procedure 6-10
 - Engineering Debug Check 6-5
 - Keypad 8-9
 - Model Assembly (MA) Test Mode 8-13, 8-14
 - Power-Up 8-8
 - procedures 6-8
 - Registration/Call 8-4
 - Reset 8-11
 - Reset Log 8-12
 - RX BER 8-7
 - SQE 8-5
 - TX Power 8-6
 - technology
 - digital modulation 1-1
 - voice compression 1-3
 - terms and definitions
 - glossary G-1
 - test
 - conditions 5-1
 - environments 7-1
 - modes 6-1, 8-1
 - procedures 8-1
 - test equipment A-6
 - additional 4-5
 - calibrating 7-1
 - checking cables 7-1
 - preparing 7-1
 - R-2660 7-2
 - recommended A-6
 - reference accessories 4-5
 - reference unit 4-5
 - required 8-1
 - RSS 7-2
 - test mode 6-3, 8-1
 - test modes and procedures
 - field level 8-1
 - testing mode displays 6-2
 - tests
 - Accessory Swap 5-4
 - Audio 8-10

- Audio Loopback 6-4
- basic procedures 6-1
- Battery Connections 5-5
- Call Performance 5-12
- Codeplug Repair Procedure 6-9
- Codeplug Troubleshooting 6-10
- Corrupted Software Repair Procedure 6-10
- Engineering Debug Check 6-5
- equipment preparation 7-1
- ESN and IMEI Matching 6-5
- Keypad 8-9
- Lockup 5-4
- Model Assembly (MA) Test Mode 8-13, 8-14
- Passcode 5-7
- Power-Up 8-8
- preparing for 7-1
- Programming Menu Settings Check 5-7
- Registration/Call 8-4
- Reset 8-11
- Reset Log 8-12
 - See also mechanical checks
 - See also self-test procedures
 - See also technician tests
- RX BER 8-7
- Shock and Pressure 5-3
- SQE 8-5
- TX Power 8-6
- Voltage Recognition 5-6
- time allocation 1-2
- Time Division Multiple Access
 - overview 1-2
 - RF signal time allocation 1-2
- tones, alert 3-4
- tools, recommended A-6
- transmission bursts 1-3
- troubleshooting 5-7, 6-10
- TX Power test 8-6

U

- unit
 - alert tones 3-4
 - cleaning 5-2
 - connecting to RSS workstation 6-8
 - displays in testing mode 6-2
 - dual band 1-4
 - equipment preparation 7-1
 - errors 3-2
 - icons 1-3
 - LED indicators 1-3
 - mechanical checks 5-3
 - messages 3-3
 - power-down sequence 3-2
 - power-up sequence 3-1
 - preparing for testing 7-1
 - programming 6-8
 - reference 4-5
 - self tests 5-7
 - troubleshooting 5-7, 6-10
- using RSS 7-2

V

- Vector Sum Excited Linear Prediction (VSELP) 1-3
- vibrator
 - function 3-7
 - modes 3-7
 - settings 3-7
- voice
 - channels 1-4
 - compression 1-3
- Voltage Recognition test 5-6
- VSELP
 - See Vector Sum Excited Linear Prediction

© 2003 by Motorola, Inc.
8000 W. Sunrise Blvd.
Ft. Lauderdale, FL 33322
Printed in U.S.A. 9/03.
All Rights Reserved.



68P80400P61-O