

REVISIONS	
GSM SERVICE SUPPORT GROUP	2004.02.03
Level 3 Schematics	Rev. 1.0
Y80	_P4
Alexander Huebler, Michael Hansen	Page 1 of 6

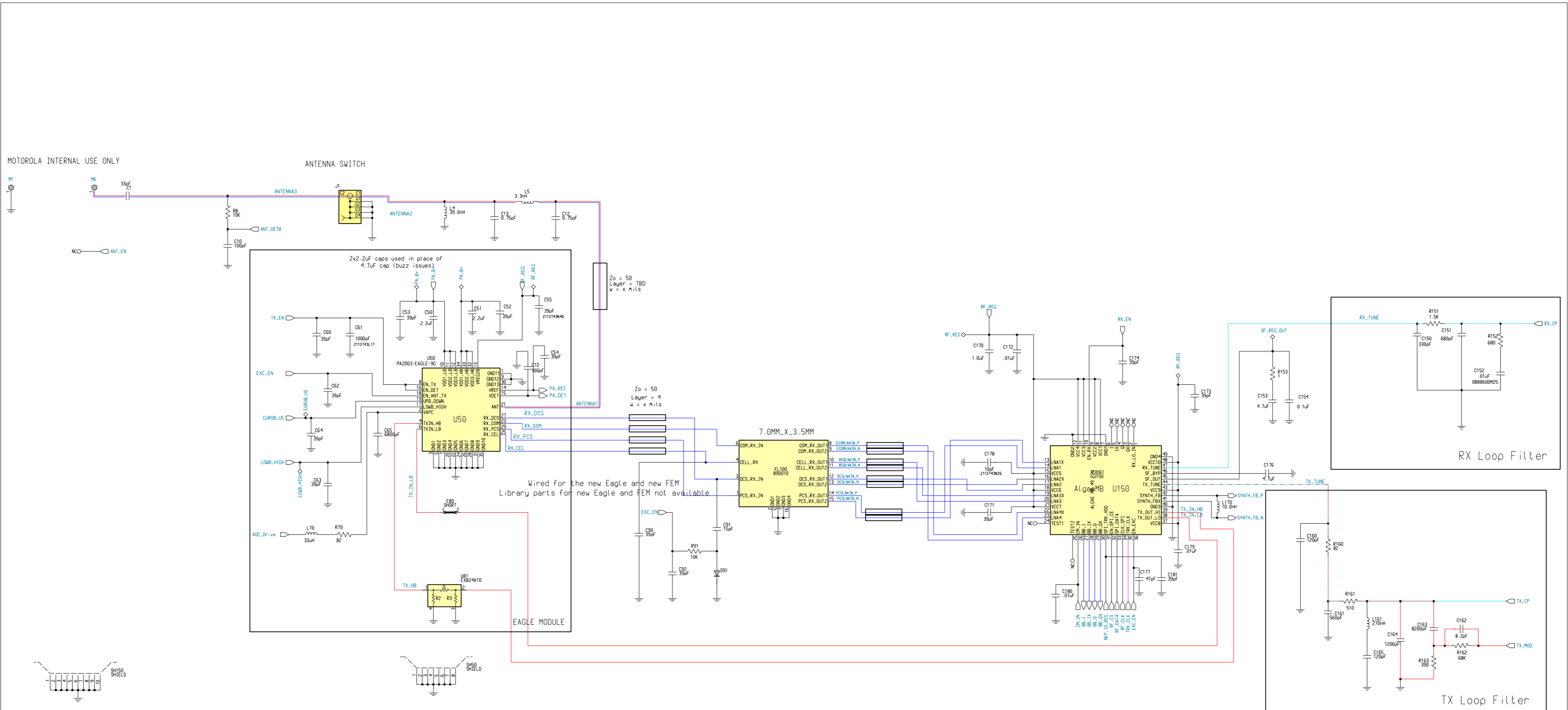

REVISIONS	
GSM SERVICE SUPPORT GROUP	2004-02-03
Level 3 Schematics	Rev. 1.0
V80	_P4
Alexander Buehler, Michael Hansen	Page 2 of 6

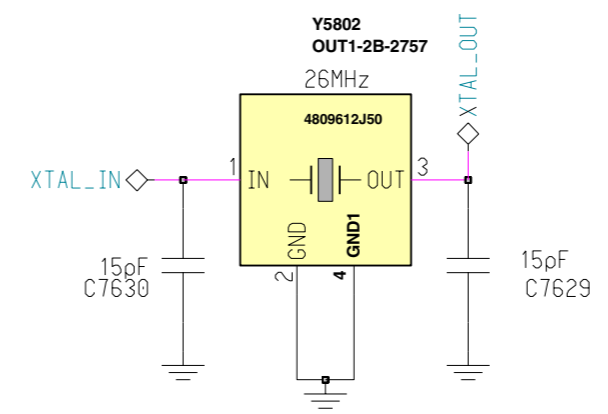
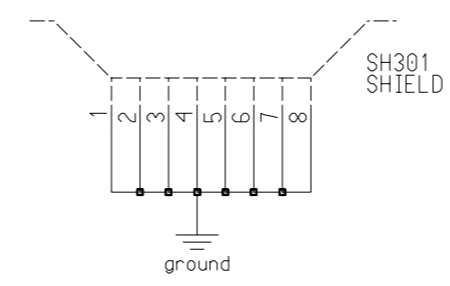
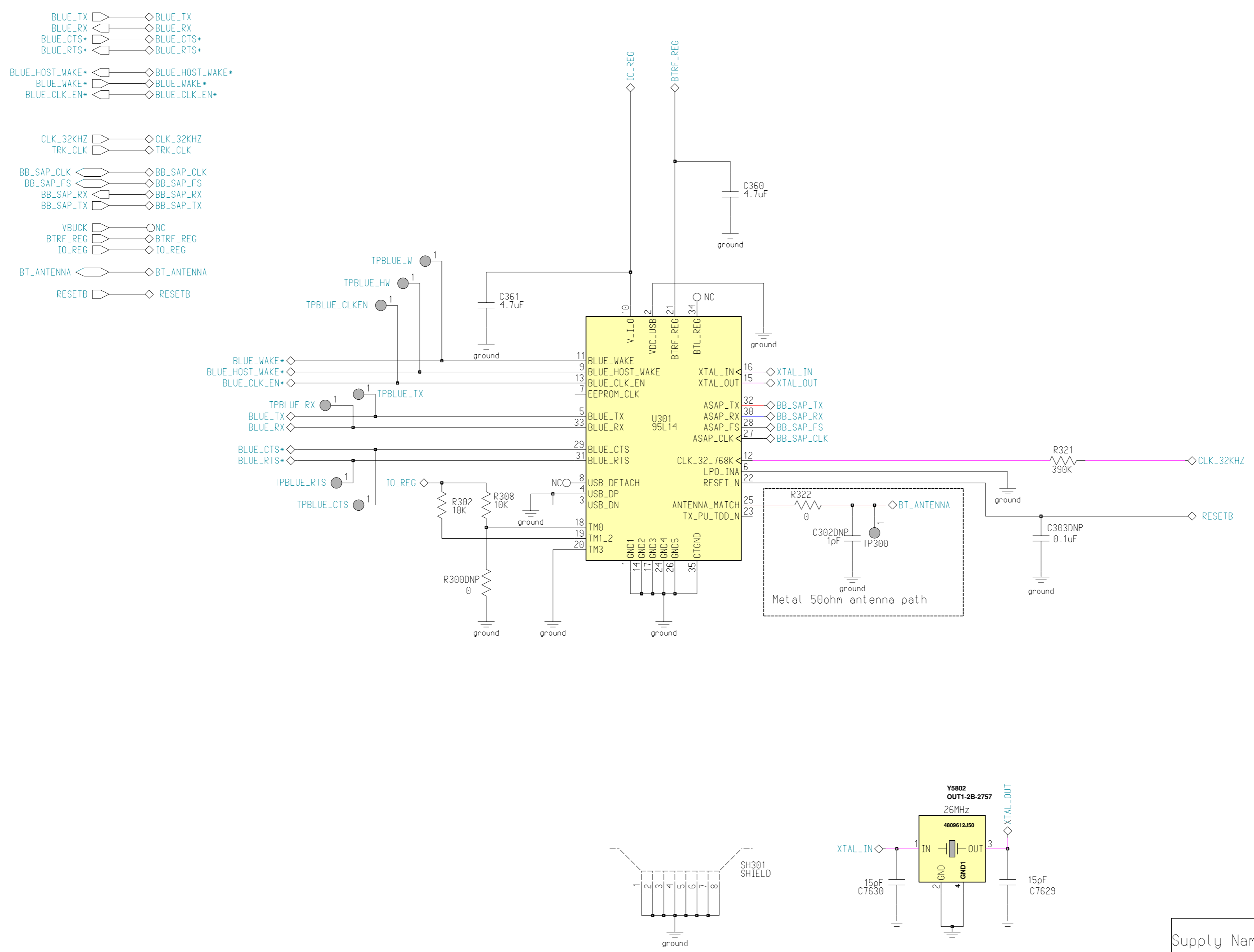

Supply Name	VDC
BTRF_REG	1.8
VBUCK	1.8
IO_REG	2.75

Remove the MOD Test point and resistor R805 on the Final production board.
Need to add Jumper to Wing board.

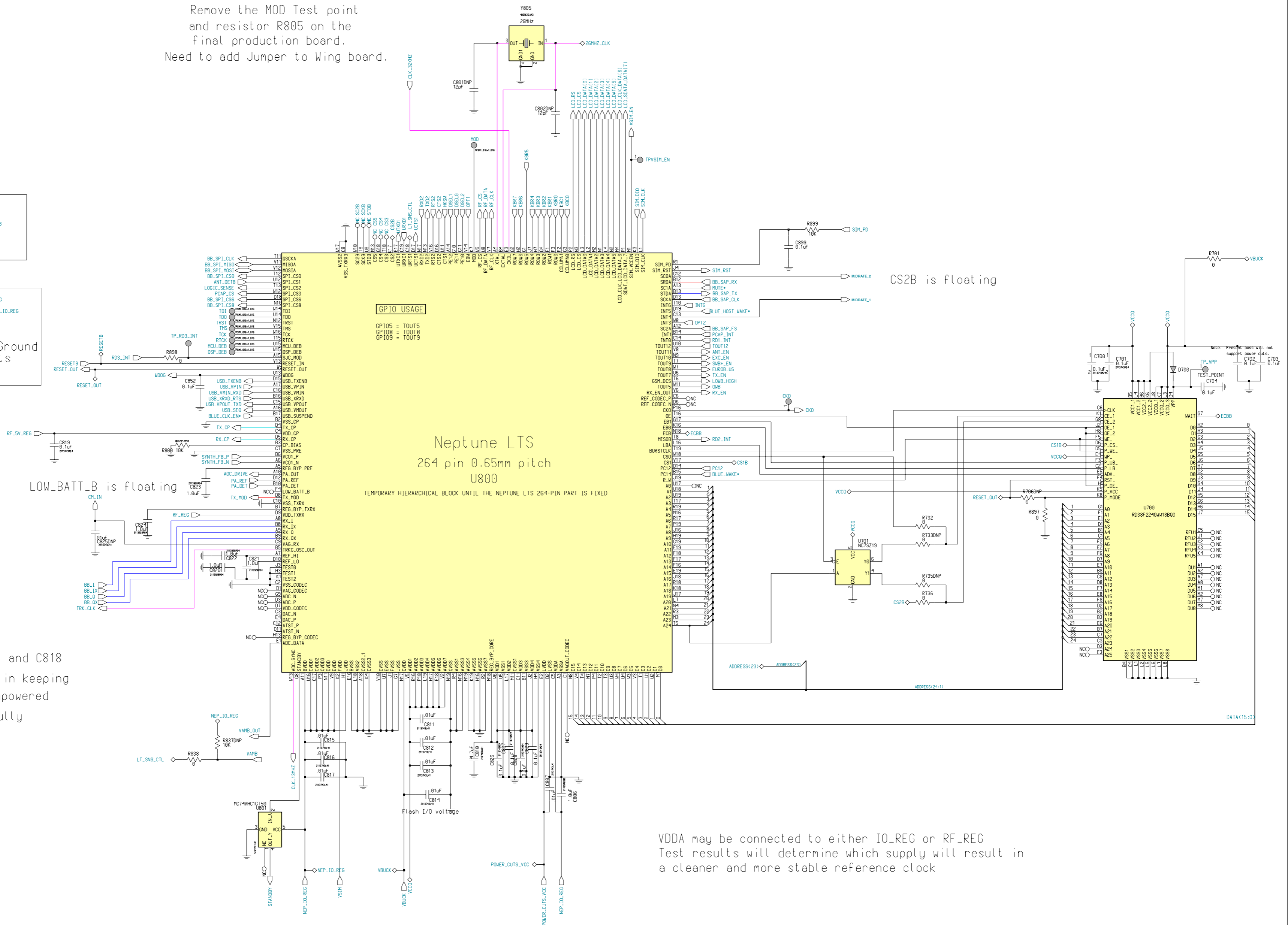
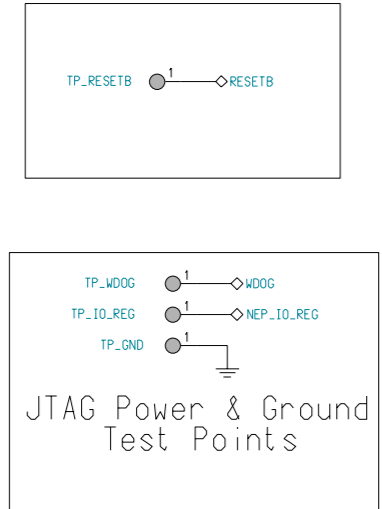

Only place R810, R811 and C818 if there is an issue in keeping the CODEC and ADC unpowered
Route JVDD carefully

V80_P04

REVISIONS	
GSM SERVICE SUPPORT GROUP	2004.02.03
Level 3 Schematics	Rev. 1.0
V80	_P4
Alexander Buehler, Michael Hansen	Page 4 of 6

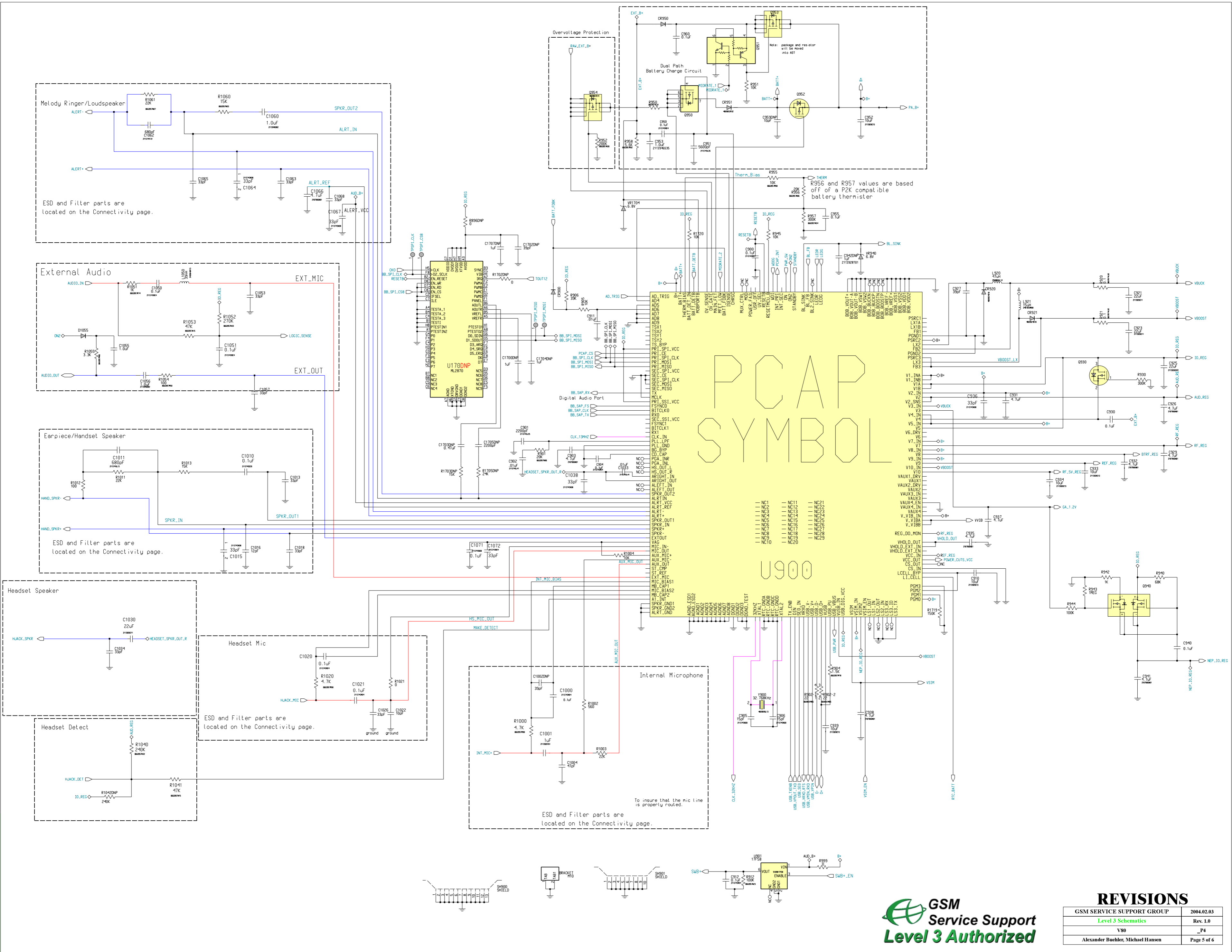

PCAP
SYMBOL

U900

REVISIONS	
GSM SERVICE SUPPORT GROUP	2004.02.03
Level 3 Schematics	Rev. 1.0
V80	_P4
Alexander Buehler, Michael Hansen	Page 5 of 6



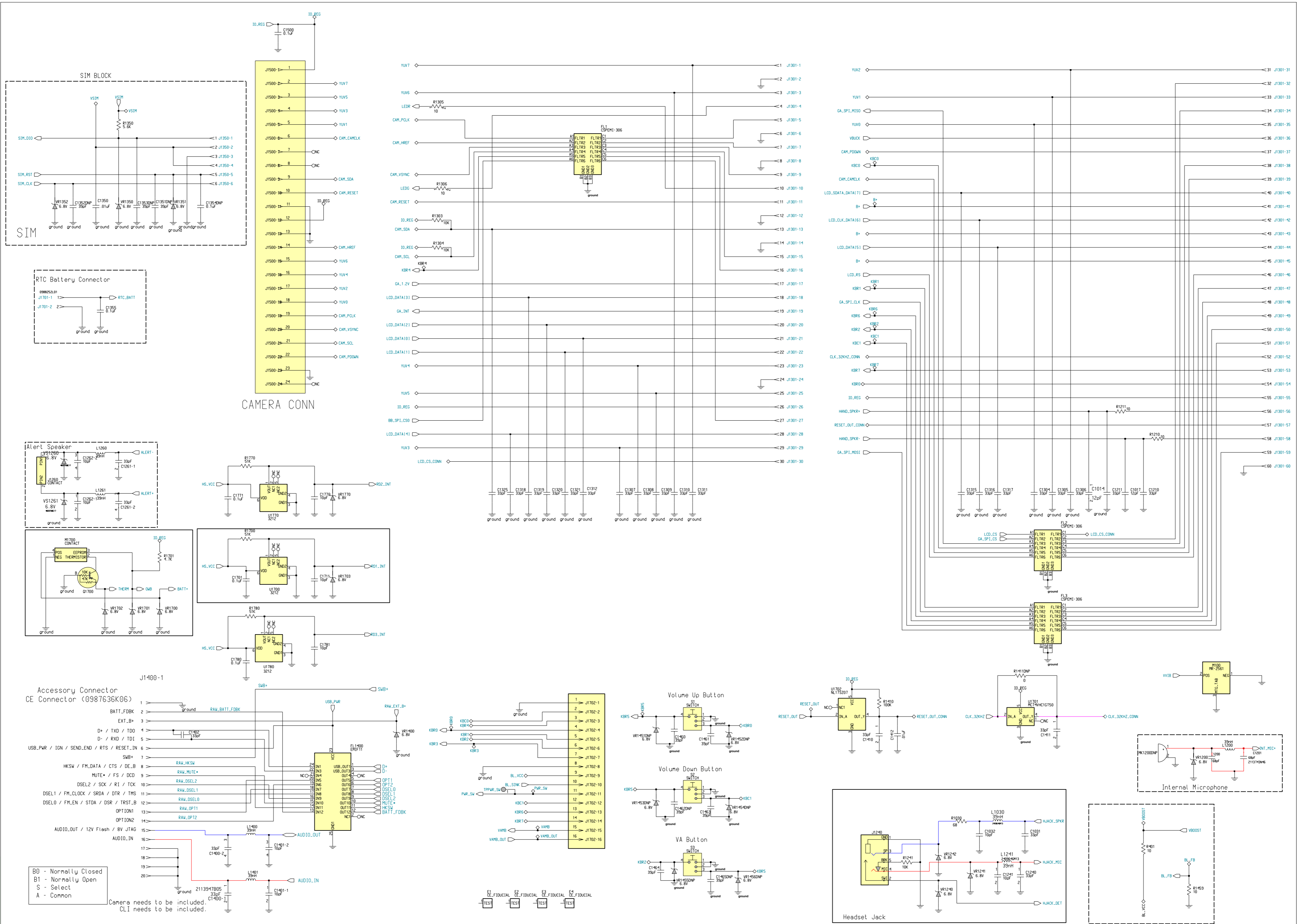

REVISIONS	
GSM SERVICE SUPPORT GROUP	2004.02.03
Level 3 Schematics	Rev. 1.0
V80	_P4
Alexander Buehler, Michael Hansen	Page 6 of 6