



Level 1 and 2 Service Manual

Product Families C25 & C43

Dual Band Wireless Telephone



Talkabout® 191, 190
GSM 900/1800 MHz

Table of Contents

Introduction	1
Product Identification	1
Product Names	1
Product Changes	1
Regulatory Agency Compliance	1
Computer Program Copyrights	2
About This Service Manual	2
Warranty Service Policy	3
Parts Replacement	4
Specifications	5
Product Overview	6
Features	6
General Operation	9
Controls, Indicators, and Input / Output (I/O) Connectors	9
User Interface Menu Structure	13
Alert Settings	15
Battery Function	15
Operation	15
Tools and Test Equipment	17
Disassembly	18
Removing and Replacing the Battery	18
Removing and Replacing the Subscriber Identity Module (SIM)	19
Removing and Replacing the Rear Escutcheon	20
Removing and Replacing the Rear Housing	20
Removing and Replacing the Antenna	22
Removing and Replacing the Vibrator and Vibrator Grommet	23
Removing and Replacing the Alert Transducer Assembly	24
Removing and Replacing the Transceiver Board	25
Removing and Replacing the RTC Battery	26
Removing and Replacing the Keypad	27
Removing and Replacing the Earpiece Speaker	28
Removing and Replacing the Microphone and Microphone Grommet	29
Removing and Replacing the Keypad Switch Dome Array	30
SIM Card and Identification	32
SIM Card	32
Identification	32
Troubleshooting	34
Manual Test Mode	34
Manual Test Mode Commands	34
Troubleshooting Chart	35
Programming: Software Upgrade and Flexing	37
Part Number Charts	38
Exploded View Diagram	38
Exploded View Parts List	39
Model-dependent Part Numbers	40
Accessories	41
Related Publications	41
Index	Index-1

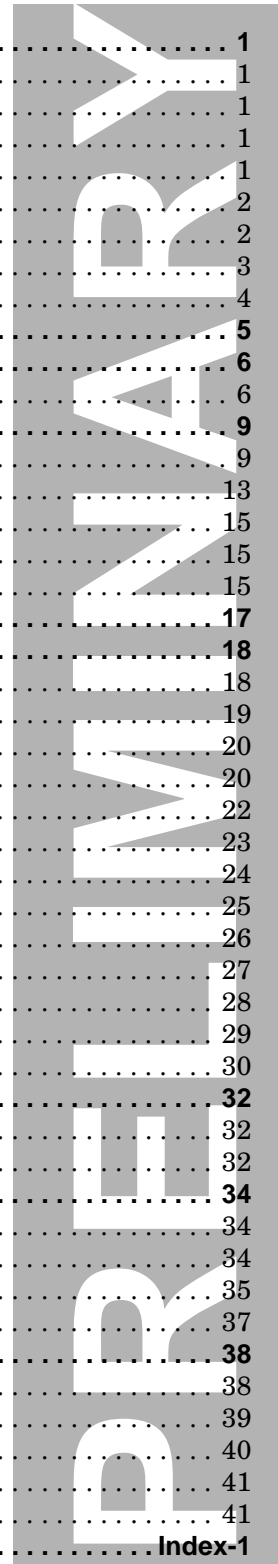

PRELIMINARY

Introduction

Motorola® Inc. maintains a worldwide organization that is dedicated to provide responsive, full-service customer support. Motorola products are serviced by an international network of company-operated product care centers as well as authorized independent service firms.

Available on a contract basis, Motorola Inc. offers comprehensive maintenance and installation programs which enable customers to meet requirements for reliable, continuous communications.

To learn more about the wide range of Motorola service programs, contact your local Motorola products representative or the nearest Customer Service Manager.

Product Identification

Motorola products are identified by the model number on the housing. Use the entire model number when inquiring about the product. Numbers are also assigned to chassis and kits. Use these numbers when requesting information or ordering replacement parts.

Product Names

Product names included in Product Family C25 and C43 telephones are listed on the front cover. Product names are subject to change without notice. Some product names, as well as some frequency bands, are available only in certain markets.

Product Changes

When electrical, mechanical or production changes are incorporated into Motorola products, a revision letter is assigned to the chassis or kit affected, for example; -A, -B, or -C, and so on.

The chassis or kit number, complete with revision number is imprinted during production. The revision letter is an integral part of the chassis or kit number and is also listed on schematic diagrams and printed circuit board layouts.

Regulatory Agency Compliance

This device complies with Part 15 of the FCC Rules. Operation is subject to the following conditions:

1. This device may not cause any harmful interference, and
2. this device must accept interference received, including interference that may cause undesired operation.

This class B device also complies with all requirements of the Canadian Interference-Causing Equipment Regulations (ICES-003).

Cet appareil numérique de la classe B respecte toutes les exigences du Règlement sur le matériel brouilleur du Canada.

Computer Program Copyrights

The Motorola products described in this manual may include Motorola computer programs stored in semiconductor memories or other media that are copyrighted with all rights reserved worldwide to Motorola. Laws in the United States and other countries preserve for Motorola, Inc. certain exclusive rights to the copyrighted computer programs, including the exclusive right to copy, reproduce, modify, decompile, disassemble, and reverse-engineer the Motorola computer programs in any manner or form without Motorola's prior written consent. Furthermore, the purchase of Motorola products shall not be deemed to grant either directly or by implication, estoppel, or otherwise, any license or rights under the copyrights, patents, or patent applications of Motorola, except for a nonexclusive license to use the Motorola product and the Motorola computer programs with the Motorola product.

About This Service Manual

Using this service manual and the suggestions contained in it assures proper installation, operation, and maintenance of PF C25 and C43 telephones. Refer questions about this manual to the nearest Customer Service Manager.

A product family is the group of products having the same Account Product Code (APC). To locate the APC on a device, refer to "Mechanical Serial Number (MSN)" later in this manual.

Audience

This document aids service personnel in testing and repairing PF C25 and PF C43 telephones. Service personnel should be familiar with electronic assembly, testing, and troubleshooting methods, and with the operation and use of associated test equipment.

Use of this document assures proper installation, operation, and maintenance of Motorola products and equipment. It contains all service information required for the equipment described and is current as of the printing date.

Scope

The scope of this document is to provide the reader with basic information relating to PF C25 and PF C43 telephones, and also to provide procedures and processes for repairing the units at Level 1 and 2 service centers including:

- Unit swap out
- Repairing of mechanical faults
- Basic modular troubleshooting
- Testing and verification of unit functionality
- Initiate warranty claims and send faulty modules to Level 3 or 4 repair centers.

PRELIMINARY

Conventions

Special characters and typefaces, listed and described below, are used in this publication to emphasize certain types of information.



Note: Emphasizes additional information pertinent to the subject matter.



Caution: Emphasizes information about actions which may result in equipment damage.



Warning: Emphasizes information about actions which may result in personal injury.



Keys to be pressed are represented graphically. For example, instead of “Press the Enter Key”, you will see “Press ”.

Information from a screen is shown in text as similar as possible to what appears in the display. For example, **ALERTS** or `ALERTS` or `ALERTS`.

Information that you need to type is printed in **boldface type**

Revisions

Any changes that occur after manuals are printed are described in publication revision bulletins (*PMRs*). These bulletins provide change information that can include new parts listing data, schematic diagrams, and printed board layouts.

Warranty Service Policy

The product will be sold with the standard 12 months warranty terms and conditions. Accidental damage, misuse, and extended warranties offered by retailers are not supported under warranty. Non warranty repairs are available at agreed fixed repair prices.

Out of Box Failure Policy

The standard out of box failure criteria applies. Customer units that fail very early on after the date of sale, are to be returned to Manufacturing for root cause analysis, to guard against epidemic criteria. Manufacturing to bear the costs of early life failure.

Product Support

Customer's original units will be repaired but not refurbished as standard. Appointed Motorola Service Hubs will perform warranty and non-warranty field service for level 2 (assemblies) and level 3 (limited PCB component). The Motorola HTC centers will perform level 4 (full component) repairs.

Parts Replacement

Customer Support

Customer support is available through dedicated Call Centers and in-country help desks. Product Service training should be arranged through the local Motorola Support Center.

When ordering replacement parts or equipment, include the Motorola part number and description used in the service manual or supplement.

When ordering crystals or channel elements, specify the Motorola part number, description, crystal frequency, and operating frequency desired.

When the Motorola part number of a component is not known, use the product model number or other related major assembly along with a description of the related major assembly and of the component in question.

In the U.S.A., to contact Motorola, Inc. on your TTY, call: 800-793-7834

Accessories and Aftermarket Division (AAD)

Replacement parts, test equipment, and manuals can be ordered from AAD.

U.S.A

Phone: 800-422-4210

FAX: 800-622-6210

Outside U.S.A.

Phone: 847-538-8023

FAX: 847-576-3023

Specifications

General Function	Specification
Frequency Range GSM	880-915 MHz Tx (with EGSM) 925-960 MHz Rx
Frequency Range DCS	1710-1785 MHz Tx 1805-1880 MHz Rx
Channel Spacing	200 kHz
Channels	174 EGSM
Modulation	GMSK at BT = 0.3
Transmitter Phase Accuracy	5 Degrees RMS, 20 Degrees peak
Duplex Spacing	45 MHz
Frequency Stability	± 0.10 ppm of the downlink frequency (Rx)
Operating Voltage	+3.0V dc to +5.1V dc (battery) 3.6V, 600mA (external connector)
Transmit Current	185 - 250 mA average talk current drain
Stand-by Current	Typically 6mA (DRX2), 4mA (DXR9)
Dimensions,	106 mm x 40 mm x 16 mm (4.17 inches X 1.57 inches X.63 inches)
Size (Volume)	68 cc (x.x in ³), with 500 mAh battery
Weight	85 gm (2.9 oz), with 500 mAh battery
Temperature Range	-10° C to +55° C (+15° F to +130° F)
Battery Life, 550 Ni Mh Battery	Talk Time 120 to 300 minutes Standby 50 to 120 hours
Battery Charge Time	3 Hours
Alert Volume	95 dB @ 5 cm

Transmitter Function	Specification
RF Power Output	33 dBm nominal GSM 900, 30 dBm nominal GSM 1800
Output Impedance	50 ohms nominal
Spurious Emissions	-36 dBm from 0.1 to 1 GHz, -30 dBm from 1 to 4 GHz

Receiver Function	Specification
Receive Sensitivity	Better than -103 dBm
RX bit error rate (100k bits) Type II	< 2%
Channel Hop Time	500 microseconds
Time to Camp	Approximately 5-10 seconds

Speech Coding Function	Specification
Speech Coding Type	Regular pulse excitation / linear predictive coding with long term prediction (RPE LPC with LTP)
Bit Rate	13.0 kbps
Frame Duration	20 ms
Block Length	260 bits
Classes	Class 1 bits = 182 bits; Class 2 bits = 78 bits
Bit Rate with FEC Encoding	22.8 kbps

Product Overview

Features

Motorola PF C25 and PF C43 mobile telephones feature global system for mobile communications (GSM) air interface, and wireless application protocol (WAP) Internet browser (PFC25 only). The PF C25 and PF C43 telephones incorporate a new user interface (UI) for easier operation, allows short message service (SMS) text messaging, and includes personal information manager (PIM) functionality. It is a dual-band phone that allows roaming within the GSM 900 MHz and digital cellular system (DCS) 1800 MHz bands. PF C25 telephones support SMS in addition to traditional circuit switched transport technologies.

PF C25 and PF C43 telephones are made of a polycarbonate plastic. The display and speaker, as well as the keypad, transceiver printed circuit board (PCB), microphone, external accessory connector, volume buttons, power button, and voice button, are contained within the flat form-factor housing. The phone accepts both 3V and 5V mini subscriber identity module (SIM) cards which fit into the SIM holder underneath the battery. The antenna is a fixed stub type antenna.

The PF C25 and PF C43 telephones use advanced, self-contained, sealed, custom integrated circuits to perform the complex functions required for GSM communication. Aside from the space and weight advantage, microcircuits enhance basic reliability, simplify maintenance, and provide a wide variety of operational functions.

Features available in this family of telephones include:

- Ergonomic design for comfort and enhancement of one hand operation
- Icon Based Simplified User Interface
- Animated Screen Savers
- Lower voltage technology that provides increased standby and talk times
- Extended GSM (EGSM) channels
- Tri-coder/decoder (CODEC) that allows full rate, half rate, and enhanced full rate modes of transmission
- Supports SMS, concatenated SMS, and cell broadcast messages
- WAP 1.1 compliant
- 700 mm² 98 x 64 pixel, high resolution 4 line graphic display
- Icon based simplified user interface
- Display zoom
- Display animation
- VibraCall® vibrating alert
- Voice recorder personal memo feature
- Voice activation for phone book entries and menu shortcuts
- Simplified text entry using iTAP™ predictive text entry
- Supports calling name presentation
- Supports call forwarding for incoming voice, fax, and data calls
- Supports 3V and 5V SIM cards
- SIM Toolkit (STK), Class II

PRELIMINARY

Speaker Dependant Voice Recognition and Voice Note Recording

This feature allows voice tags to be used for voice dialing up to 20 phone numbers in the phone book and for creating up to 5 voice shortcuts for menu items. The phone must be “trained” by the voice tag being read into the phone’s memory twice before it is recognized.

Voice tags can be added to the phone’s memory using the usual name addition methods (i.e., via the phone book menu structure or with the shortcut editor).

➔ *The user cannot place or receive calls while adding voice tags to the phone’s memory.*

➔ *Because the GSM standard does not provide the option to store voice tags onto the SIM card, voice tags are added to the phone’s memory.*

Wireless Access Protocol (WAP) 1.1 Compliancy

In the WAP environment, access to the Internet is initiated in wireless markup language (WML), which is derived from hypertext markup language (HTML). The request is passed to a WAP gateway which retrieves the information from the server in standard HTML (subsequently filtered to WML) or directly in WML if available. The information is then passed to the mobile subscriber via the mobile network.

The PF C25’s microbrowser can be configured for baud, idle timeout, line type, phone number, and connection type.

➔ *Bitmap image data will download as text. If the image is larger than the screen, only part of the image will display.*

➔ *If the user receives a call while in browser mode, the browser will pause and allow the user to resume after completing the call.*

Simplified Text Entry

There are three different ways to enter text using the phone keypad:

- iTAP™ predictive text entry. Press a key to generate a character and a dynamic dictionary uses this to build and display a set of word or name options. The iTAP™ feature may not be available on the phone in all languages.
- Tap. Press a key to generate a character.
- Numeric. The keypad produces numeric characters only. For some text areas this is the only method available; for example, phone numbers.

Caller Line Identification

Upon receipt of a call, the calling party’s phone number is compared to the phone book. If the number matches a phone book entry, that name will be displayed. If there is no phone book entry, the incoming phone number will be displayed. In the

PRELIMINARY

event that no caller identification information is available, the message INCOMING CALL is displayed.

User must subscribe to a caller line identification service through their service provider.

Call Forwarding

Call forwarding is a network feature that diverts incoming calls to another phone number if the user or phone is unavailable, or the user does not wish to receive calls. This option can be used to:

- Divert all incoming voice calls unconditionally
- Divert incoming voice calls whenever the phone is unavailable, busy, not reachable, or not answered
- Divert incoming fax calls
- Divert incoming data calls
- Allow all calls through to the phone.

Detailed operating instructions for these and the other PF C25 and PF C43 features can be found in the appropriate PF C25 and PF C43 telephone user's guide listed in the "Related Publications" section toward the end of this manual.

General Operation

Controls, Indicators, and Input / Output (I/O) Connectors

The PF C25 and PF C40 telephone controls are located on the keyboard. The headphone jack and power jack are on the side and bottom, respectively. Indicators, in the form of icons, are displayed on the LCD (see Figure 1 and Figure 2).



T191_controls.eps

Figure 1. PF C25 Controls and indicators locations

The PF C43 Telephone is similar in appearance to the PF C25 telephone but has a slightly different keypad appearance.











Function and Keypad Keys

The keys on the front of the telephone (in conjunction with the display) provide the phone's user interface (UI). The function keys, positioned above the keypad, are described in Figure 2.

The PF C25 and PF C43 keypad operates as a conventional telephone keypad. The alpha characters used in text messaging functions are shown in Figure 3.

PRELIMINARY

PRELIMINARY

Keys	Commands and functions
	<p>Power on/off key</p> <ul style="list-style-type: none"> • Long press to switch your phone on/off. • Press to end or cancel a call. • Press to return to the previous menu. • Exit browser and back to idle.
	<p>Send/Answer key</p> <ul style="list-style-type: none"> • Press to send or answer a call. • In idle mode, long press to redial the last call number. • In idle, press to display last dialed/missed numbers. • Press to select or activate an option.
	<p>Menu key</p> <ul style="list-style-type: none"> • Accessing the main menu from idle. • During a call, press to access the Call Options menu. • During input, press to access the input mode menu. • Browser's 2nd soft key.
	<p>Right soft key</p> <p>Executes the command shown at the bottom right of the display:</p> <ul style="list-style-type: none"> • In menus, press to select or activate an option (as SEL/OK/OPTION shows). • In idle, press to access the Messages menu. (as  shows). • Confirms entered digits/text during input (as OK shows). • Links to the next web page/selects a browser menu option during an Internet session. • Browser's 1st soft key.
	<p>Left soft key</p> <p>Executes the command shown at the bottom left of the display:</p> <ul style="list-style-type: none"> • In menus, press to abort a selection/operation and return to the previous menu or screen (as QUIT/EXIT shows). • In idle, press to access the Phone Book menu (as  shows). • During input, press to clear one digit/character; long press to clear all digits/characters (as DEL shows). • During an Internet session, press to return to the previous page; long press to return to homepage.
	<p>Scroll key</p> <ul style="list-style-type: none"> • Scrolling the menus and options. • Adjusting volume during a call. • In idle mode, press to access Quick Access menu. • In idle mode, long press to access phone book directory/initiate voice dial (if voice dial feature is activated). • During input, press once to move cursor to the next/last insertion point; long press to move the cursor continuously.
	<p>Voicemail key</p> <ul style="list-style-type: none"> • In idle, long press to dial the voice mail box number. • During an internet session, long press to access the browser menu.
	<p>Lock key</p> <ul style="list-style-type: none"> • In idle, long press to lock the keypad.
	<p>Number key</p> <ul style="list-style-type: none"> • In idle, long press to dial any of the first 9 phone numbers saved in the Phone Book. • In menus, press to access a corresponding option directly.

T191_funckeys.eps

Figure 2. PF C25 Function keys

PRELIMINARY

Key	Lower case
1	, . : 1 % ! ? ; " ' < > () @ &
2 ^{ABC}	A B C 2 Å Ä å ä à ç æ ß
3 ^{DEF}	D E F 3 è é É £ Æ \$
4 ^{GHI}	G H I 4 ì í ? π
5 ^{JKL}	J K L 5 Δ _ Φ Γ Λ Ω
6 ^{MNO}	M N O 6 Ñ ñ ò Ö ö Ø ø
7 ^{PQRS}	P Q R S 7 Υ §
8 ^{TUV}	T U V 8 ü Ü ù
9 ^{WXYZ}	W X Y Z 9 Π Ψ Σ Θ Ξ
0+	0 (Space)
*☒	+ - * / =
#0	# P

T191_alpnumkeys.eps

Figure 3. PF C25 Alphanumeric keys

Liquid Crystal Display (LCD)

The LCD provides a high contrast backlit display for easy readability in all light conditions. The large bit-mapped 98 x 64 pixel display includes 3 lines of text, 1 line of icons, and 1 line of soft key labels.

Display animation makes the phone's menus move smoothly as the user scrolls up and down. Turn animation off to conserve the battery.



Whether a phone displays all indicators depends on the programming and services to which the user subscribes.

PRELIMINARY

Figure 4 shows the appearance of the PF C25 display when idle.

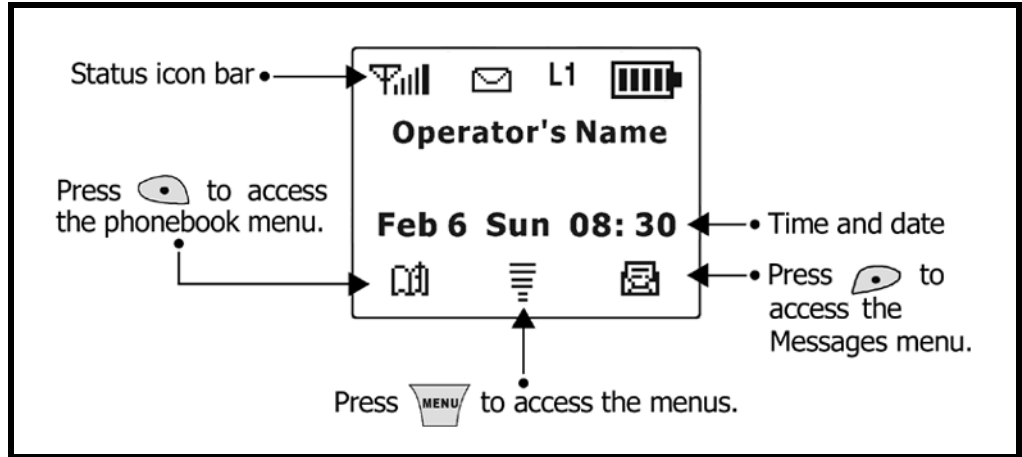

T191_display.eps

Figure 4. PF C25 Idle display

The phone's icon indicators are shown in Figure 5.

Icon	Function	Descriptions
	Signal Strength	Signal strength of your designated network. The more bars displayed, the stronger the signal.
	Short message	Receiving a short text message or having unread messages.
	Voice mail waiting	You have a new voice mail.
	Call divert	All incoming calls are diverted to a designated number.
L1	Line in use	The current line in use.
	Vibration only	Your phone only vibrates without ringing when a call comes in.
	Battery	Battery power level, the more the battery power. Four bars: full. No bars: Recharging immediately. The icon scrolls during charging until the battery is full.
	Key lock	Key lock is activated.
	Roaming	When your phone is not used on your home network, this icon will appear.

T191_icons.eps

Figure 5. PF C25 Icon indicators

- **Signal Strength Indicator.** Shows the strength of the phone's connection with the network. Calls cannot be sent or received when the "no signal" indicator is displayed.

PRELIMINARY

- **Short Message.** Appears when the phone receives a text message or has an unread text message. This is a network-dependent feature.
- **Voice Mail Waiting.** Appears when a voicemail message is received. This is a network-dependent feature.
- **Call Divert.** All incoming calls are diverting to a designated number.
- **Line In Use.** Indicates the current line is in use.
- **Vibration Only.** The phone vibrates without ringing when a call is received.
- **Battery Level Indicator.** Shows the amount of charge left in the battery. The more segments visible, the greater the charge. When no bars are visible, recharge the battery as soon as possible.
- **Key Lock.** Indicates that the phone's key pad locked is activated.
- **Roam Indicator.** Appears when the phone uses another network system outside the user's home network. When leaving the home network area, the phone roams, or seeks, another network.
- **Menu Indicator.** Indicates the user can press the menu soft key to open a menu.
- **Clock.** Shows the current time. This is a network-dependent feature.

User Interface Menu Structure

Menu Navigation

PF C25 and PF C43 telephones are equipped with a simplified user-friendly interface that employs soft keys and a 2-way scroll key to access phone functions and features. See Figure 1.

"Soft keys" refer to non-labeled keys that correspond to text options displayed on the screen. The left and right soft keys perform the function shown in the corners of the display. The left key will usually select an option whereas the right key will usually exit a function or return to a previous screen.

The menu key opens the initial menu structure, or allows access to a submenu whenever  appears on the screen. See Figure 6 for details of the PF C25 menu structure.

PRELIMINARY

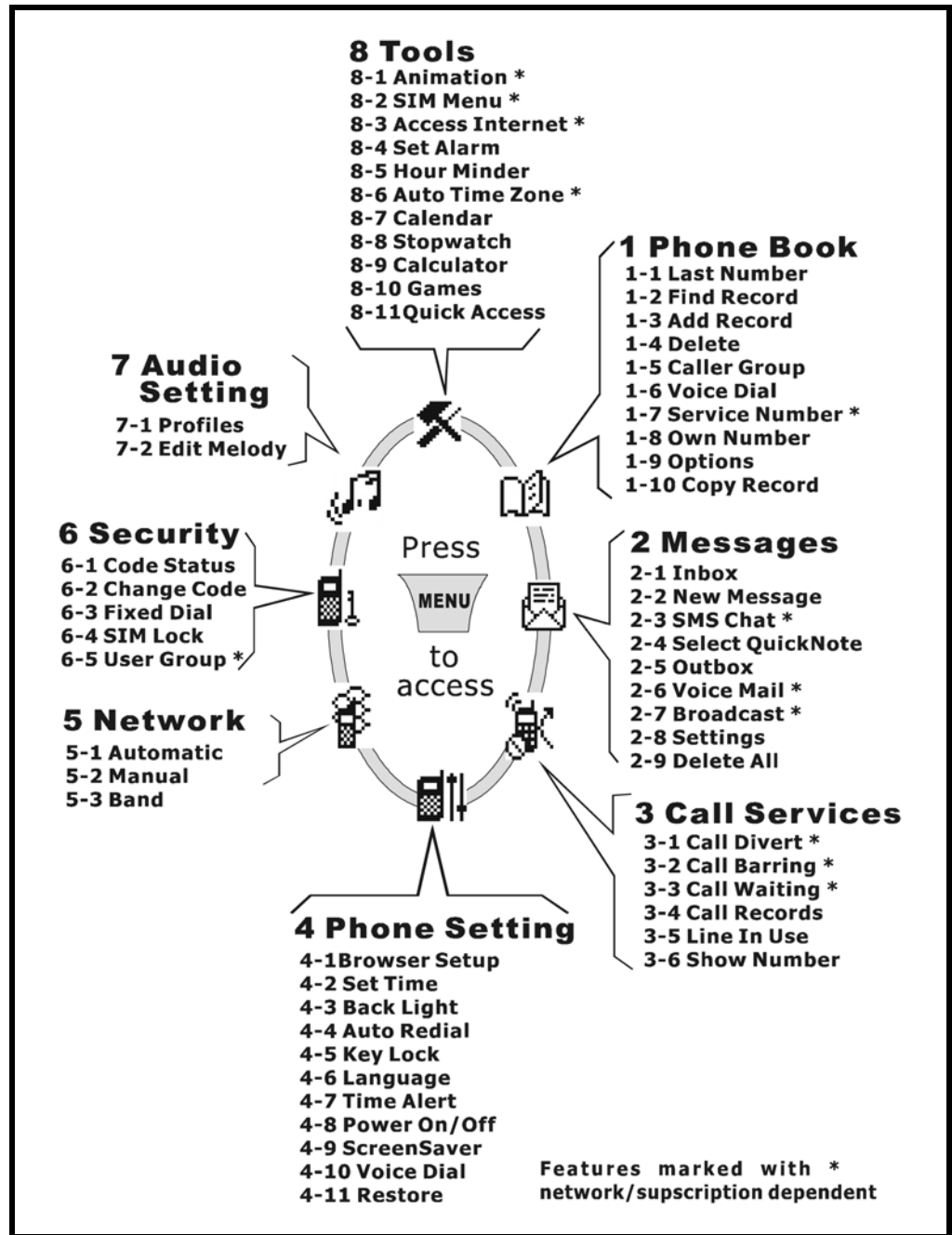

Figure 6. PF C25 Menu structure

T191_mwnu.eps

Alert Settings

PF C25 and PF C43 telephones include up to 32 preset alert tones and vibrations that can be applied individually to specific alert events or to all events at the same time.



Pressing either volume key will mute the alert.

Battery Function

Battery Gauge

The telephone displays a battery level indicator icon in the idle screen to indicate the battery charge level. The gauge shows four levels: 100%, 66%, 33%, and Low Battery.

Battery Removal

Removing the battery causes the device to immediately shut down and any pending work (for example, partially entered phone book entries or outgoing messages) is lost.



All batteries can cause property damage and / or bodily injury such as burns if a conductive material such as jewelry, keys, or beaded chains touch exposed terminals. The conductive material may complete an electrical circuit (short circuit) and become quite hot. Exercise care in handling any charged battery, particularly when placing it inside a pocket, purse, or other container with metal objects.



If the battery is removed while receiving a message, the message will be lost.



To ensure proper memory retention, turn the phone OFF before removing the battery. Immediately replace the old battery with a fully charged battery.

Operation

For detailed operating instructions, refer to the appropriate User's Guide listed in the Related Publications section toward the end of this manual.

PRELIMINARY

PRELIMINARY

Tools and Test Equipment

The following tables list the tools and test equipment used on the PF C25 telephone. Use either the listed items or equivalents.

Table 1. General Test Equipment and Tools

Motorola Part Number ¹	Description	Application
See Table 6	Charger	Used to charge battery and to power device
0180386A82	Antistatic Mat Kit (includes 66-80387A95 antistatic mat, 66-80334B36 ground cord, and 42-80385A59 wrist band)	Provides protection from damage to device caused by electrostatic discharge (ESD)
6680388B67	Disassembly tool, plastic with flat and pointed ends (manual opening tool)	Used during assembly/disassembly of device
RSX4043-A	Torque Driver	Used to remove and replace screws
	Torque Driver Bit T-5, Apex 440-5IP Torx Plus or equivalent	Used with torque driver
6680388B01	Tweezers, plastic	Used during assembly/disassembly
HP34401A ²	Digital Multimeter	Used to measure battery voltage

1. To order in North America, contact Motorola Aftermarket and Accessories Division (AAD) at (847) 538-8000; Internationally, AAD can be reached by calling (847) 538-8023 or faxing (847) 576-3023.

2. Not available from Motorola. To order, contact Hewlett Packard at (800) 452-4844.

Disassembly

The procedures in this section provide instructions for the disassembly of PF C25 and PF C43 telephones. Tools and equipment used for the phone are listed in Table 1, preceding.



Many of the integrated devices used in this equipment are vulnerable to damage from electrostatic discharge (ESD). Ensure adequate static protection is in place when handling, shipping, and servicing the internal components of this equipment.



Avoid stressing the plastic in any way to avoid damage to either the plastic or internal components.

Removing and Replacing the Battery



All batteries can cause property damage and/or bodily injury such as burns if a conductive material such as jewelry, keys, or beaded chains touch exposed terminals. The conductive material may complete an electrical circuit (short circuit) and become quite hot. Exercise care in handling any charged battery, particularly when placing it inside a pocket, purse, or other container with metal objects.

1. Ensure the phone is turned off.

- Depress the battery latch and slide it in the direction of the arrow (see Figure 7).

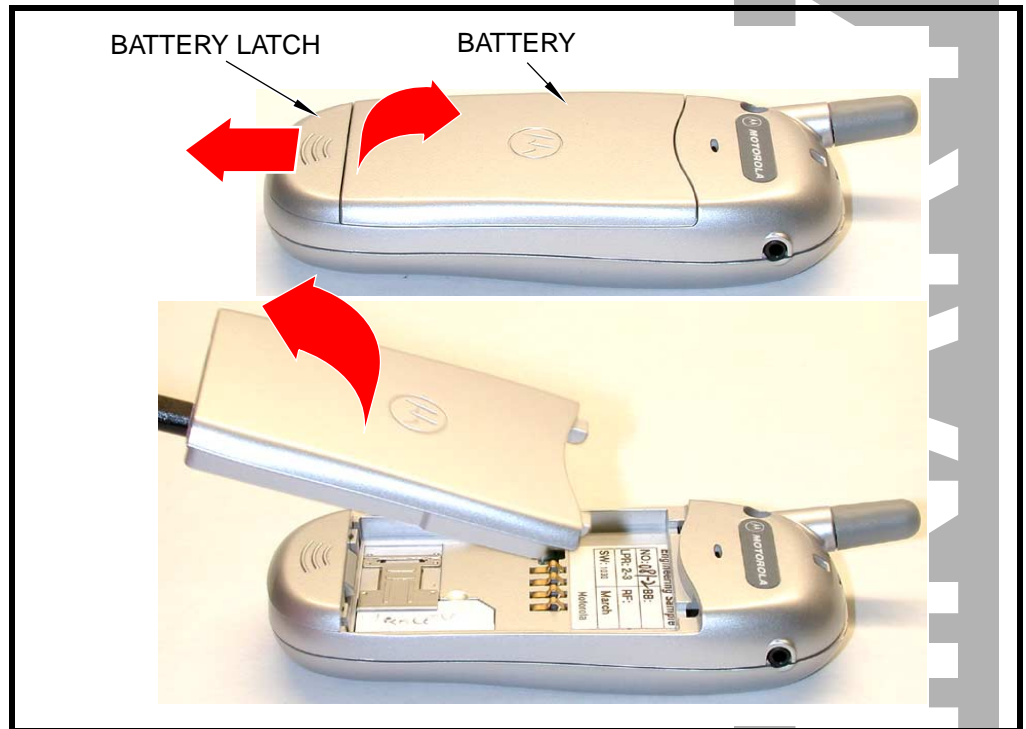

Figure 7. Removing the battery

T191_battery_rem.eps

- Lift the bottom end of the battery from the phone, then remove it completely as shown in the figure.



There is a danger of explosion if the Nickel Metal Hydride battery is replaced incorrectly. Replace only with the same type of battery or equivalent as recommended by the battery manufacturer. Dispose of used batteries according to the manufacturer's instructions.

- To replace, align the battery with the battery compartment so the contacts on the battery match the battery contacts in the phone.
- Slide the top of the battery into the receptacle molded into the housing, then press the bottom end of the battery securely into the battery compartment until it locks into place.

Removing and Replacing the Subscriber Identity Module (SIM)

- Remove the battery as described in the procedures.
- Slide the SIM latch in the direction of the arrow to unlock as shown in Figure 8.

3. Rotate the SIM and slide it out as shown in the figure.

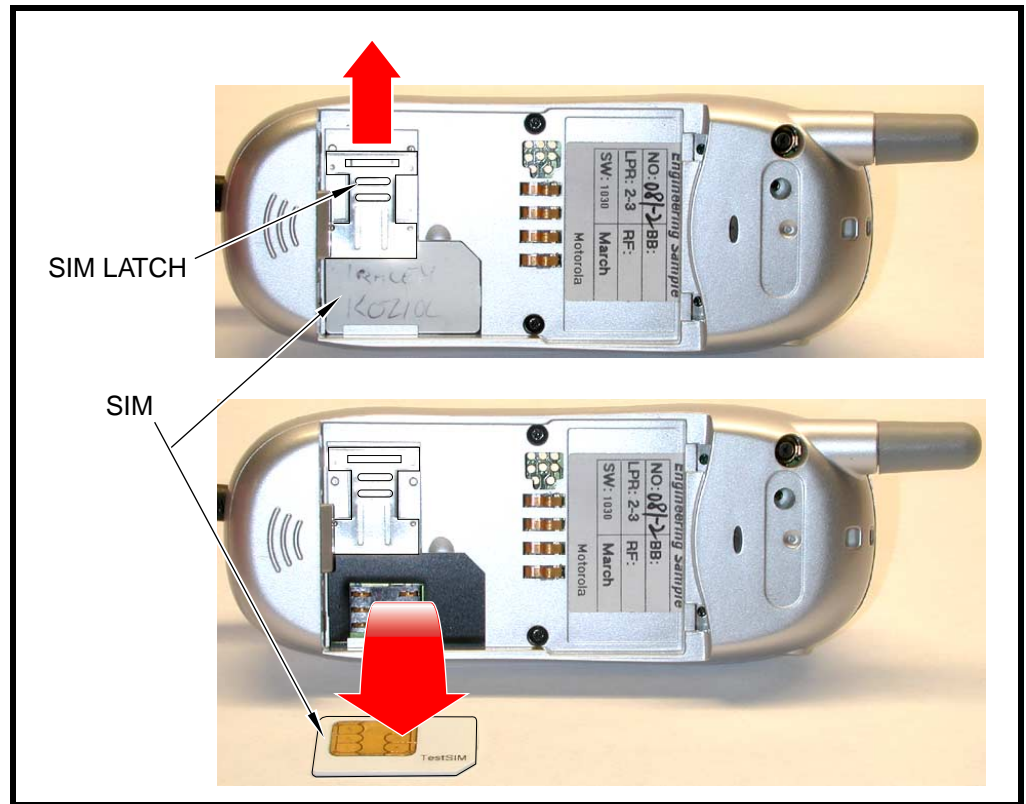

T191_SIM_rem.eps

Figure 8. Removing the SIM

4. To replace, carefully insert the SIM into the SIM holder. Be sure the SIM is correctly positioned to contact the terminals when closed.
5. Slide the SIM latch to lock in place.
6. Replace the battery as described in the procedures.

PRELIMINARY

Removing and Replacing the Rear Escutcheon

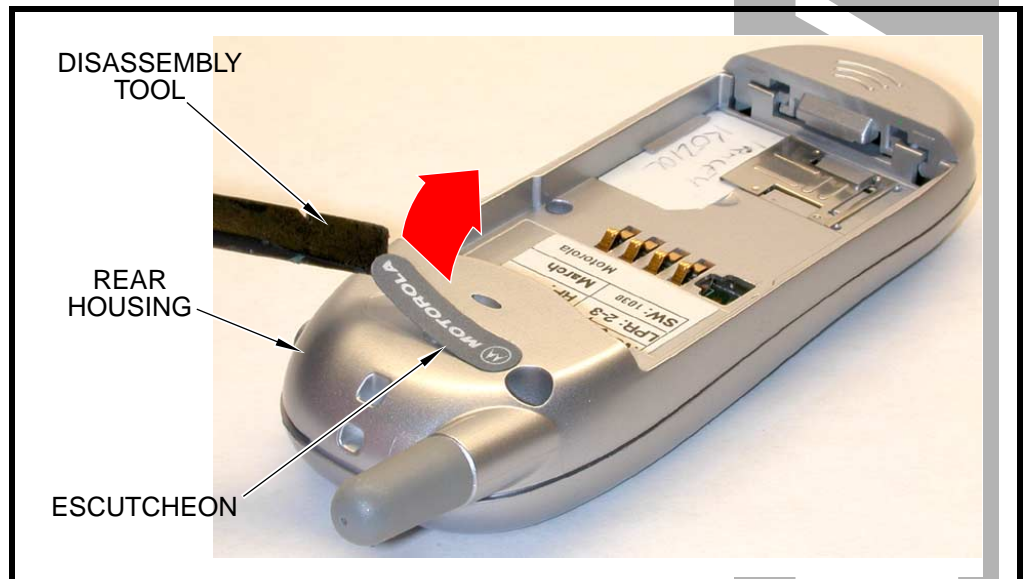

Figure 9. Removing the rear escutcheon

1. Remove the battery as described in the procedures.
2. Using the flat end of the disassembly tool, carefully peel the escutcheon from the rear housing. See Figure 9.
3. To replace, remove the protective paper backing from the new escutcheon and carefully align it with the cavity molded into the rear housing.
4. Press the escutcheon firmly into place making sure pressure is applied evenly across the entire surface to ensure a tight bond.
5. Replace the battery as described in the procedures.

Removing and Replacing the Rear Housing



This product contains static-sensitive devices. Use anti-static handling procedures to prevent electrostatic discharge (ESD) and component damage.



The housing is fastened with plastic catches. These are delicate and should be parted using utmost care.

1. Remove the battery and SIM as described in the procedures.

2. Locate the 4 screws holding the front housing to the rear housing. See Figure 10.

Push the battery latch in the direction of the arrow to expose the 2 bottom housing screws as shown in Figure 10.

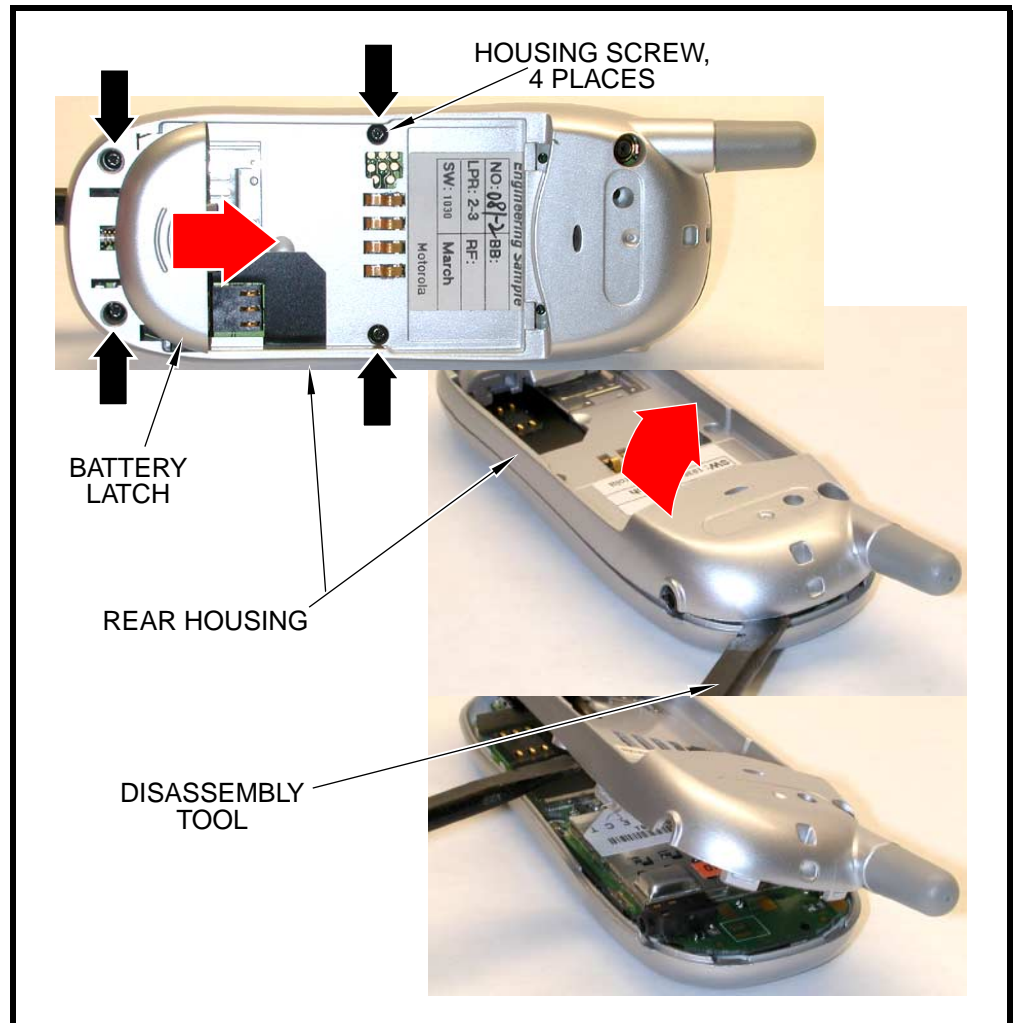

T191_rearhsg_rem.eps

Figure 10. Removing the Rear Housing

3. Using the Torx driver with a T5 bit, remove the 4 screws and set aside for reuse.
4. Using the flat end of the disassembly tool, carefully disengage the catches on the top and both sides of the housing, then separate the rear housing from the front housing.
5. Lift the rear housing from the front housing as shown in the figure.
6. To replace, align the front housing with the rear housing then firmly press together until the catches engage and the housings are properly assembled.
7. Replace the 4 screws and tighten firmly. Do not over tighten.

PRELIMINARY

8. Slide the battery latch toward the bottom of the phone until it snaps into place.
9. Replace the SIM and battery as described in the procedures.

Removing and Replacing the Antenna

1. Remove the battery, SIM, and rear housing as described in the procedures.
2. Using a firm even pressure, pull the antenna straight out of the rear housing to remove. See Figure 11.

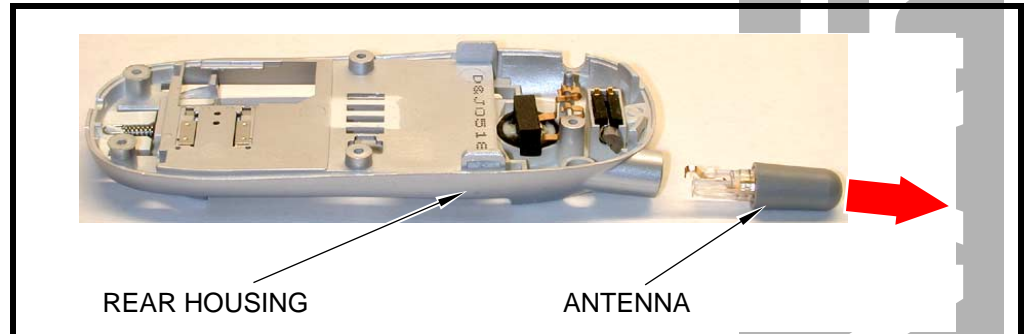

Figure 11. Removing the antenna

T191_antenna_rem.eps



Exercise caution when handling the antenna to prevent damage to the antenna terminal.

3. To replace, insert the end of the antenna carefully into the housing and, after ensuring the antenna terminal is correctly aligned to contact the transceiver board when reassembled, push straight into the housing until it snaps into place.
4. Replace the rear housing, SIM, and battery as described in the procedures.

Removing and Replacing the Vibrator and Vibrator Grommet

1. Remove the battery, SIM, and rear housing as described in the procedures.

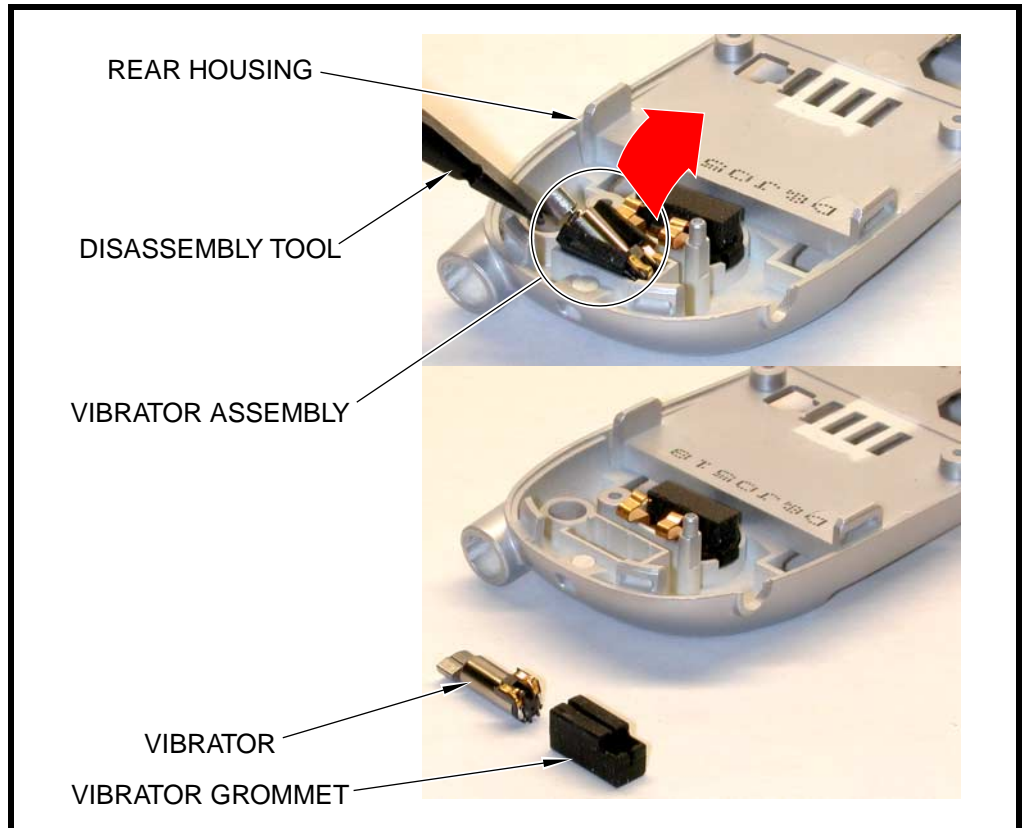

Figure 12. Removing the vibrator and vibrator grommet

2. Using the flat end of the disassembly tool, carefully pry the vibrator assembly from its cavity in the rear housing as shown in Figure 12. The assembly should come away from the rear housing easily.
3. Separate the vibrator from the vibrator grommet.
4. To replace, insert the vibrator into the grommet. Ensure the vibrator shaft can rotate freely.
5. Align the vibrator assembly with the rear housing so the vibrator terminals will contact the transceiver board contacts when reassembled, then press into place until fully seated.
6. Replace the rear housing, SIM, and battery as described in the procedures.

PRELIMINARY

Removing and Replacing the Alert Transducer Assembly

1. Remove the battery, SIM, and rear housing as described in the procedures.
2. Using the flat end of the disassembly tool, carefully pry the transducer from its cavity in the rear housing as shown in Figure 13.



Figure 13. Removing the alert transducer assembly



The alert transducer is fastened to the rear housing with adhesive. Exercise care when removing to prevent damage to the rear housing.

3. To replace, remove the protective backing from the new transducer, then press the transducer into place in the rear housing cavity. Be sure the transducer is straight, fully seated in its cavity, and positioned so its terminals will contact the transceiver board when reassembled.
4. Replace the rear housing, SIM, and battery as described in the procedures.

Removing and Replacing the Transceiver Board



This product contains static-sensitive devices. Use anti-static handling procedures to prevent electrostatic discharge (ESD) and component damage.

1. Remove the battery, SIM, and rear housing as described in the procedures.
2. Using the flat end of the disassembly tool, carefully loosen the transceiver board from the front housing.

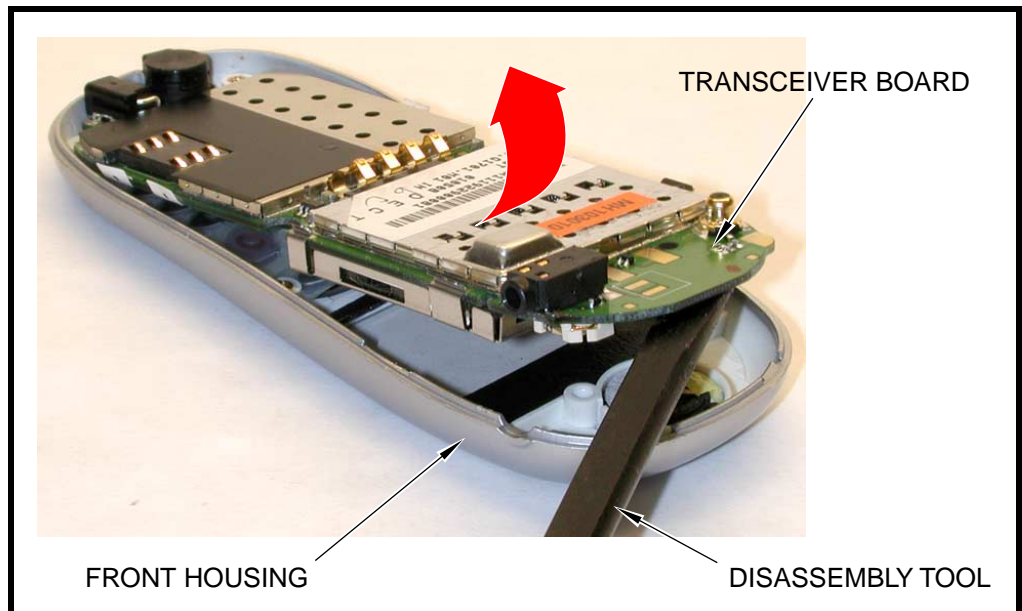

T191_pcb_rem.eps

Figure 14. Removing the transceiver board

3. Lift the transceiver board completely away from the front housing as shown in Figure 14.
4. To replace, align the transceiver board with the front housing and gently press into place.

Ensure the keypad is correctly positioned in the front housing relative to the transceiver board. Verify operation of the keys after replacing the transceiver board.

5. Replace the rear housing, SIM, and battery as described in the procedures.

PRELIMINARY

Removing and Replacing the RTC Battery

1. Remove the battery, SIM, rear housing, and transceiver board as described in the procedures.
2. Use the flat end of the disassembly tool to pry the real time clock (RTC) battery from its socket on the transceiver board. See Figure 15.



Dispose of used batteries according to the manufacturer's instructions.

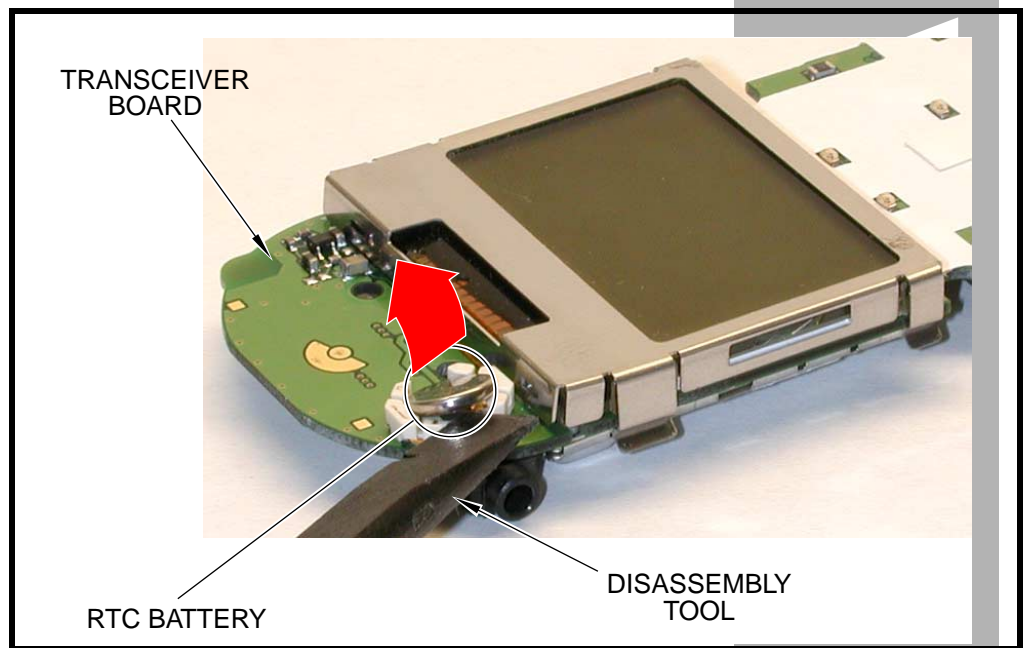

T191_rtc batt_rem.eps

Figure 15. Removing the RTC battery

3. To replace, align the new RTC battery with its socket so its positive terminal is facing upward, then snap the battery in place until it is completely seated in the socket.
4. Replace the transceiver board, rear housing, SIM, and battery as described in the procedures.

Removing and Replacing the Keypad

1. Remove the battery, SIM, rear housing, and transceiver board, as described in the procedures.

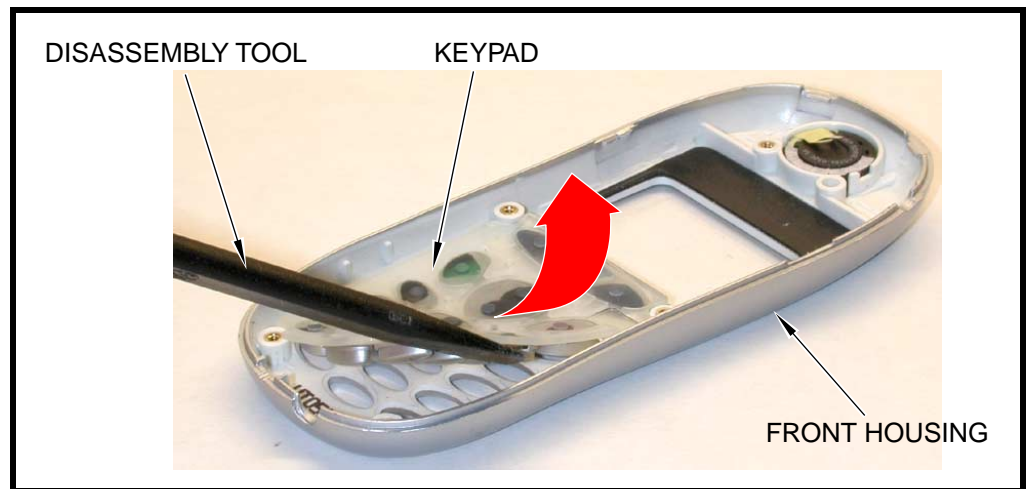

T191_keypad_rem.eps

Figure 16. Removing the keypad

2. Lift the keypad from the front housing as shown in Figure 16.
3. To replace, insert the keypad into the front housing. Ensure the keys align properly with the openings and the keypad is fully seated in the front housing.
4. Replace the transceiver board, rear housing, SIM, and battery as described in the procedures.
5. Verify correct operation.

PRELIMINARY

Removing and Replacing the Earpiece Speaker

1. Remove the battery, SIM, rear housing, and transceiver board as described in the procedures.



Figure 17. Removing the earpiece speaker

2. Using the flat end of the disassembly tool, pry the earpiece speaker from its cavity in the front housing.



The earpiece speaker is fastened to the front housing with adhesive. Exercise care when removing to prevent damage to the front housing.

3. To replace the earpiece speaker, remove the protective backing from the new earpiece speaker, then press the earpiece speaker into place in its front housing cavity. Be sure the speaker is straight, fully seated within the cavity, and positioned so its terminals will contact the transceiver board when reassembled.
4. Replace the transceiver board, rear housing, SIM, and battery as described in the procedures.

Removing and Replacing the Microphone and Microphone Grommet



This product contains static-sensitive devices. Use anti-static handling procedures to prevent electrostatic discharge (ESD) and component damage.

1. Remove the battery, SIM, rear housing, and transceiver board as described in the procedures.

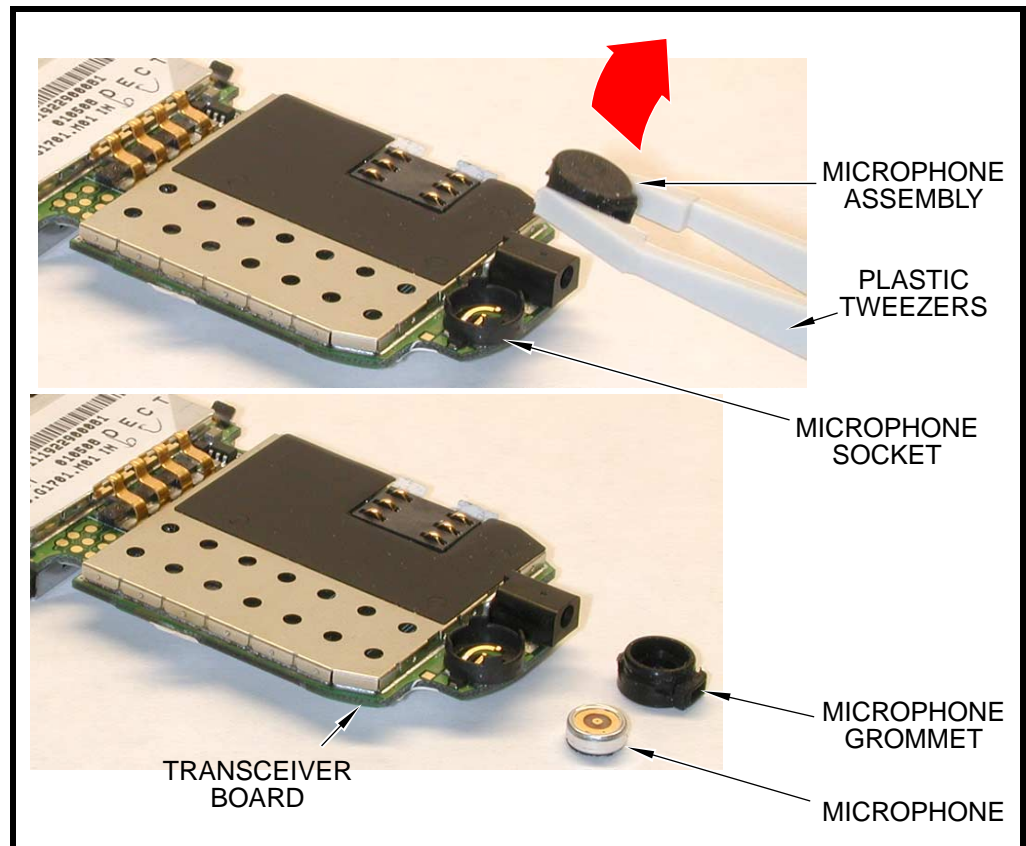

T191_mic_rem.eps

Figure 18. Removing the microphone and microphone grommet

2. Using the plastic tweezers, carefully pull the microphone assembly from its socket on the transceiver board. The microphone assembly should come out of its socket easily. See Figure 18.
3. Separate the microphone from the microphone grommet.
4. To replace, insert the microphone into the microphone grommet so the terminals on the bottom of the microphone face outward. Ensure the microphone is straight and pushed completely into the grommet.

PRELIMINARY

- Align the microphone assembly with the microphone socket press into place until fully seated.



The microphone assembly is keyed to fit the microphone socket only one way. Be sure the opening in the microphone grommet is positioned to face the opening in the housing when reassembled.

- Replace the transceiver board, rear housing, SIM, and battery as described in the procedures.

Removing and Replacing the Keypad Switch Dome Array

- Remove the battery, SIM, and transceiver board as described in the procedures.

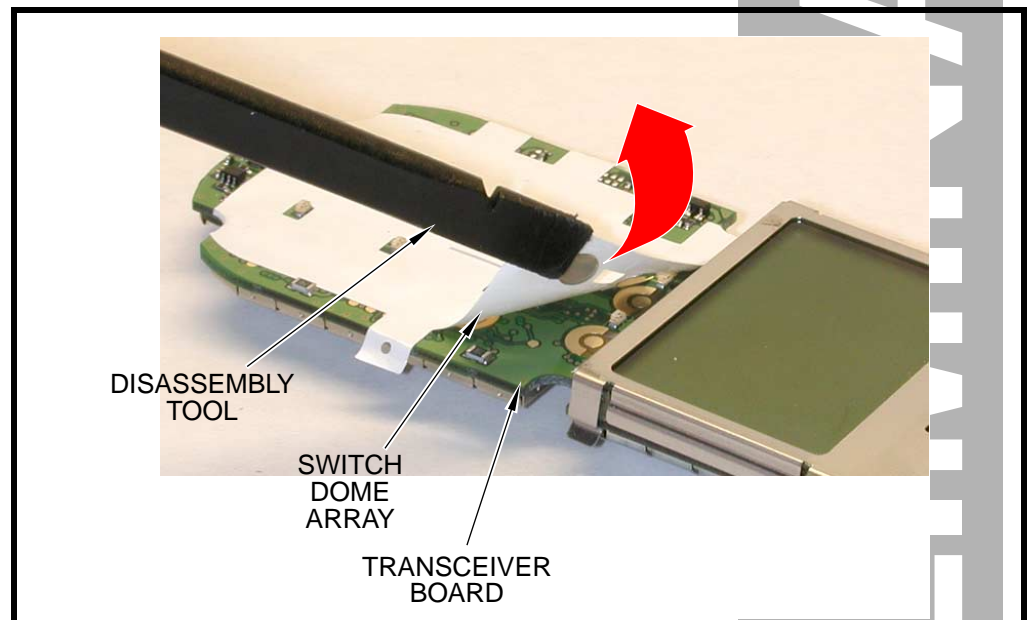

Figure 19. Removing the keypad switch dome array

- While holding the transceiver board stationary, carefully work the flat end of the disassembly tool under a corner of the keypad switch dome array as shown in Figure 16.
- Slowly peel the keypad switch dome array from the transceiver board to remove. Discard the keypad switch dome array just removed.



Do not touch the adhesive on the back of the keypad switch dome array or poor adhesion and improper operation may result.

- To replace, remove the protective backing from a new keypad switch array.
- Align the new keypad switch dome array with the transceiver board.

PRELIMINARY

6. Apply even pressure across the entire surface of the switch dome array to ensure proper adhesion.
7. Replace the transceiver board, rear housing, SIM, and battery as described in the procedures.
8. Verify correct operation.

SIM Card and Identification

SIM Card

A SIM (Subscriber Identity Module) card is required to access the existing local GSM network, or remote networks when traveling (if a roaming agreement has been made with the provider).

The SIM card contains:

- All the data necessary to access GSM services
- The ability to store user information such as phone numbers.
- All information required by the network provider to provide access to the network.

Identification

Each Motorola GSM device is labelled with a variety of identifying numbers. The following information describes the current identifying labels.

Mechanical Serial Number (MSN)

The Mechanical Serial Number (MSN) is an individual unit identity number and remains with the unit throughout the life of the unit.

The MSN can be used to log and track a unit on Motorola's Service Center Database.

The MSN is divided into 4 sections as shown in Figure 20.

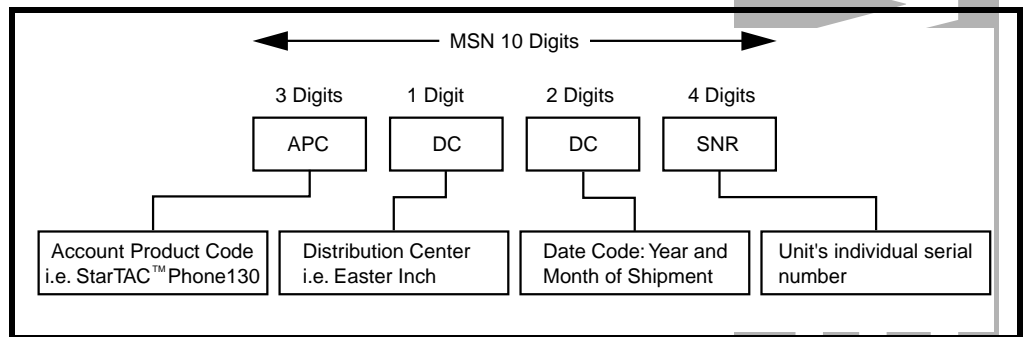

Figure 20. MSN Label Breakdown

000807-A

PRELIMINARY

International Mobile Station Equipment Identity (IMEI)

The International Mobile station Equipment Identity (IMEI) number is an individual number unique to the PCB and is stored within the unit's memory. The following diagram illustrates the various parts of this number.

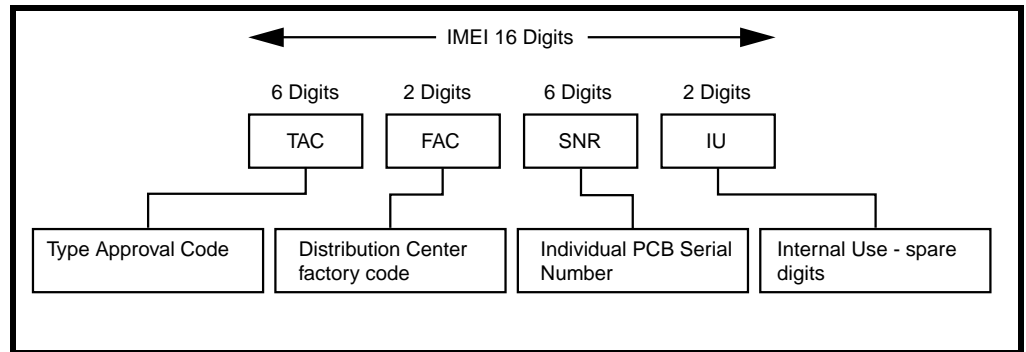

000808-O

Figure 21. IMEI Label Breakdown

Other label number configurations present are:

- **TRANSCIVER NUMBER:** Identifies the product type. Normally the SWF number. (i.e. V100).
- **PACKAGE NUMBER:** Identifies the equipment type, mode, and language in which the product is shipped.

Troubleshooting

Manual Test Mode

Motorola PF C25 and C43 telephones are equipped with a manual test mode capability. This allows service personnel to verify functionality and perform fault isolation by entering keypad commands.

To enter the manual test command mode, a GSM / DCS test SIM must be used.

1. Press **Ⓞ** to turn the phone OFF.
2. Remove the battery as described in the procedures.
3. Remove the customer's SIM card from the phone as described in the procedures.
4. Insert the test SIM into the SIM slot.
5. Replace the battery as described in the procedures.
6. Press **Ⓞ** to turn the phone ON.

Press and hold the # button for approximately 3 seconds until TEST displays on the screen. The phone may now be issued test commands listed in Table 2.

Manual Test Mode Commands

Table 2. Test Commands

Test Command	Test Function/Name
*#300# OK	List Software and Hardware version
*#301# OK	Full keypad functional test
*#302# OK	Acoustic Test ¹ 1 - Greeting 2 - Main Volume Gain 3 - Input Cal 4 - Output Cal 5 - Side In Gain 6 - Vox Gain 7 - Min Mic Energy 8 - More (a) - In Volume Gain (b) - Aux Volume Gain (c) - Silence Prd (d) - Supp Prd (e) - In Volume (f) - Out Volume (g) - Icon (h) - Image (i) - Animation
#303# OK	Settings Saved ¹
*#307# OK	Engineering Test Mode
#400# OK	ADC, Cal val ¹
*#402# OK	Adjust display Intensity/Contrast
*#403# OK	List the Manufacturing Information
1998 0722 OK	Master Unlock code for Phone and Sim Lock

1. Use with care - Contains Calibration factors

Troubleshooting Chart

Table 3. PF C25 and C43 Telephones: Level 1 and 2 Troubleshooting Chart

SYMPTOM	PROBABLE CAUSE	VERIFICATION AND REMEDY
1. Telephone will not turn on or stay on.	a) Battery either discharged or defective.	Measure battery voltage across a 50 ohm (>1 Watt) load. If the battery voltage is <3.25 Vdc, recharge the battery using the appropriate battery charger. If the battery will not recharge, replace the battery. If battery is not at fault, proceed to b.
	b) Battery terminals open or misaligned.	Visually inspect the battery terminals on both the battery and the telephone. Realign and, if necessary, either replace the battery or refer to a Level 3 Service Center for the battery connector replacement. If battery terminals are not at fault, proceed to c.
	c) Transceiver board assembly defective.	Remove the transceiver board assembly. Substitute a known good assembly and temporarily reassemble the unit. Depress the PWR button; if unit turns on and stays on, disconnect the dc power source and reassemble the telephone with the new transceiver board assembly. Verify that the fault has been cleared.
2. Telephone exhibits poor reception or erratic operation such as calls frequently dropping or weak or distorted audio.	a) Antenna assembly defective.	Check to make sure that the antenna terminal makes proper contact with the transceiver board assembly. If connected properly, substitute a known good antenna. If the fault is still present, proceed to b.
	b) Transceiver board assembly defective.	Replace the transceiver board assembly (refer to 1c). Verify that the fault has been cleared and reassemble the unit with the new transceiver board assembly.
3. Display is erratic, or provides partial or no display.	Transceiver board assembly defective.	Replace the transceiver board assembly (refer to 1c). Verify that the fault has been cleared and reassemble the unit with the new transceiver board assembly.
4. Incoming call alert transducer audio distorted or volume is too low.	a) Defective alert transducer.	Replace alert transducer according to the procedures. If fault still present, proceed to b.
	b) Faulty transceiver board assembly.	Replace the transceiver board assembly (refer to 1c). Verify that the fault has been cleared and reassemble the unit with the new transceiver board assembly.
5. Telephone transmit audio is weak. (usually indicated by called parties complaining of difficulty in hearing voice).	a) Microphone misaligned or defective.	Ensure microphone is correctly positioned in socket. If fault still present, replace the microphone as described in the procedures. If fault is not cleared, proceed to b.
	b) Transceiver board assembly defective.	Replace the transceiver board assembly (refer to 1c). Verify that the fault has been cleared and reassemble the unit with the new transceiver board assembly.
6. Receive audio from earpiece speaker is weak or distorted.	a) Earpiece speaker defective.	Temporarily replace the LCD speaker assembly with a known good assembly. Ensure good connection. Place a call and verify improvement in earpiece audio. If fault is cleared, reassemble the phone with the good assembly. If fault is not cleared, proceed to b.

Table 3. PF C25 and C43 Telephones: Level 1 and 2 Troubleshooting Chart (Continued)

SYMPTOM	PROBABLE CAUSE	VERIFICATION AND REMEDY
	b) Transceiver board assembly defective.	Replace the transceiver board assembly (refer to 1c). Verify that the fault has been cleared and reassemble with the new transceiver board assembly.
7. Telephone will not recognize or accept SIM card.	a) SIM card defective.	Check the SIM card contacts for dirt. Clean if necessary, and check if fault has been cleared. If the contacts are clean, insert a known good SIM card into the telephone. Power up the unit and confirm that the card has been accepted. If the fault no longer exists, replace the defective SIM card. If the SIM card is not at fault, proceed to b.
	b) Transceiver board assembly defective.	Replace the transceiver board assembly (refer to 1c). Verify that the fault has been cleared and reassemble the unit with the new transceiver board assembly.
8. Vibrator feature not functioning.	a) Vibrator defective.	Replace vibrator as described in the procedures. If the fault has not been cleared, proceed to b.
	b) Transceiver board assembly defective.	Replace the transceiver board assembly (refer to 1c). Verify that the fault has been cleared and reassemble the unit with the new transceiver board assembly.
9. Internal Charger not working.	Faulty charger circuit on transceiver board assembly.	insert a known good discharged battery. Connect a known good charger and verify battery is being charged. If fault still present, replace the transceiver board assembly (refer to 1c). Verify that the fault has been cleared and reassemble the unit with the new transceiver board assembly.
10. No or weak audio when using headset.	a) Headset plug not fully inserted.	Ensure the headset plug is fully seated in the jack.
	b) Faulty jack on transceiver board assembly.	Replace the transceiver board assembly (refer to 1c). Verify that the fault has been cleared and reassemble the unit with the new transceiver board assembly.

Programming: Software Upgrade and Flexing

The following hardware codes must be observed when flashing phones:

Hardware Code	Region
ID1	EMEA
ID2	Asia

Contact your local technical support engineer for information about equipment and procedures for flashing and flexing.

PRELIMINARY

Part Number Charts

The following charts are provided as a reference for the parts associated with PF C25 and C43 telephones.

Exploded View Diagram

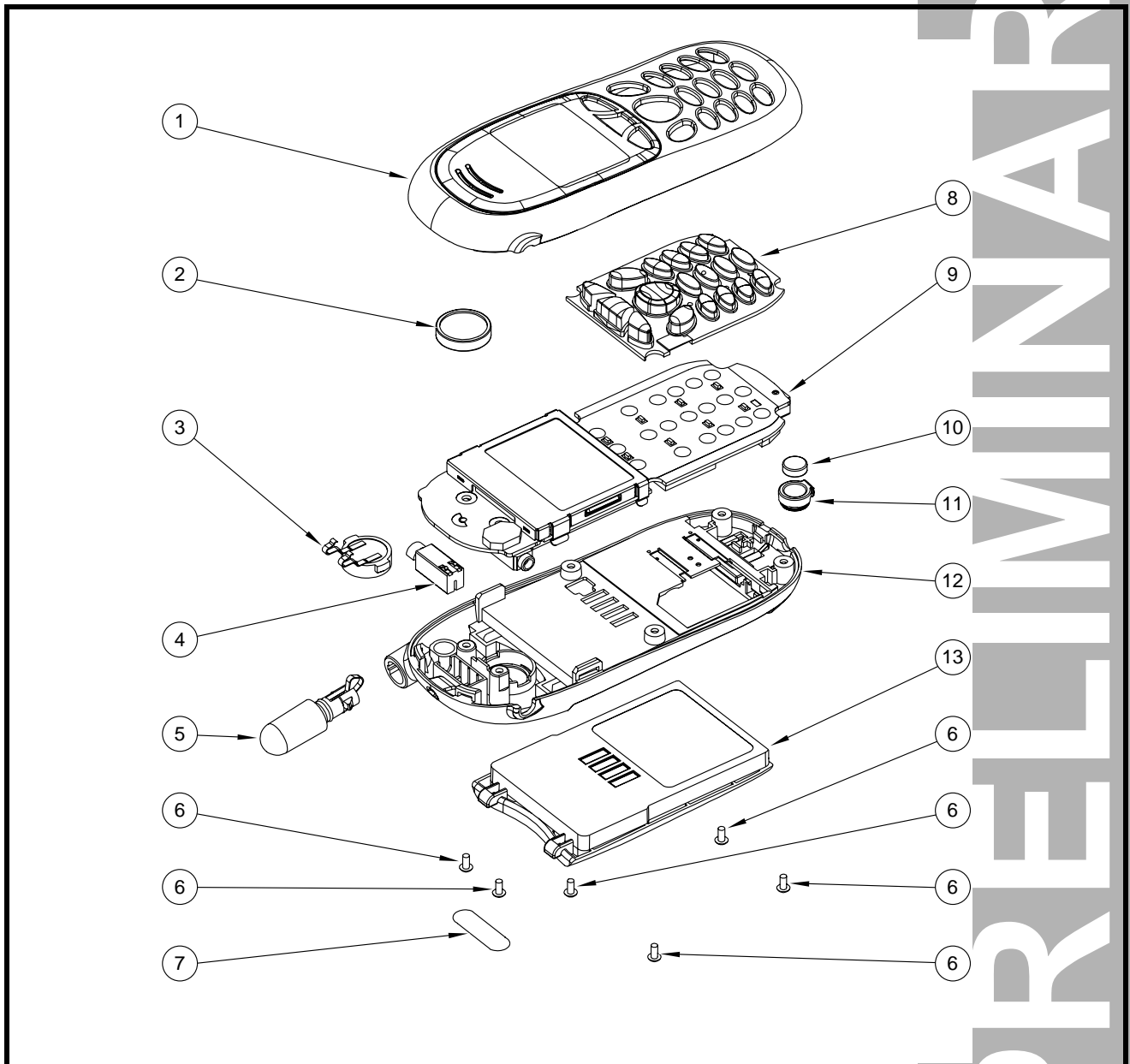

Figure 22. Exploded View Diagram

T191_expl_view.eps

Exploded View Parts List

Table 4. Exploded View Parts List

Item Number	Part Number	Description
1	see Table 5	Front housing
2	23.40051.011	Earpiece speaker
3	23.60021.001	Alert transducer
4	23.46003.001	Vibrator Assembly
5	25.90020.001	Antenna
6	86.00T03.2P1	Screw, Torx T5 (6 each)
7	1389964L01	Escutcheon
8	see Table 5	Keypad
9	see Table 5	Transceiver board assembly
10	23.42021.001	Microphone
11	47.G1703.001	Microphone grommet
12	see Table 5	Rear housing
13	see Table 6	Battery
not shown	23.20059.001	RTC battery

Item Number	Part Number	Description

Notes: 1. Not available as spares in EMEA Service markets.



There is a danger of explosion if the Nickel Metal Hydride battery pack is replaced incorrectly. Replace only with the same type of battery or equivalent as recommended by the battery manufacturer. Dispose of used batteries according to the manufacturer's instructions.

To order parts you can use the following link:

https://wissc.motorola.com/wissc_root/main/BrowserOK.html

A password is required.

For information on ordering parts for EMEA region please call +44 131 479 1274

Model-dependent Part Numbers

Table 5. Model-dependent Part Numbers

Item Number	Part Description	Part Number
1	Front housing, C25, Frosted Silver	60.G1703.012
1	Front housing, C25, Graphite Gray	60.G1703.022
1	Front housing, C25, Moonstone Blue	60.G1703.032
1	Front housing, C43, Eskimo White	
1	Front housing, C43, Smoke Gray	
1	Front housing, C43, Morning Indigo	
12	Rear housing, C25, Frosted Silver	60.G1704.002
12	Rear housing, C43,	
8	Keypad English - C25	47.G1701.001
8	Keypad Traditional Chinese - C25	47.G1701.012
8	Keypad Simplified Chinese - C25	47.G1701.022
8	Keypad English - C43	42.G2202.001
8	Keypad Traditional Chinese - C43	42.G2202.012
8	Keypad Simplified Chinese - C43	42.G2202.022
9	PCB Assembly Main Board - C25	55.G2201.001
9	PCB Assembly Main Board - C43	55.G1701.001
-	Transceiver, C25, Graphite Gray S. Asia	SUG2137AA
-	Transceiver, C25, Frosted Silver, S. Asia	SUG2138AA
-	Transceiver, C25, Moonstone Blue, S. Asia	SUG2139AA
-	Transceiver, C25, Graphite Gray, Taiwan	SUG2140AA
-	Transceiver, C25, Frosted Silver, Taiwan	SUG2141AA
-	Transceiver, C25, Moonstone Blue, Taiwan	SUG2142AA
-	Transceiver, C25, Graphite Gray, Hong Kong	SUG2143AA
-	Transceiver, C25, Frosted Silver, Hong Kong	SUG2144AA
-	Transceiver, C25, Moonstone Blue, Hong Kong	SUG2145AA
-	Transceiver, C25, Graphite Gray, PRC	SUG2300AA
-	Transceiver, C25, Frosted Silver, PRC	SUG2301AA
-	Transceiver, C25, Moonstone Blue, PRC	SUG2302AA
-	Transceiver, C25, Frosted Silver, Li-Ion	SUG2386AA
-	Transceiver, C25, Moonstone Blue, Li-Ion	SUG2387AA
-	Transceiver, C25, Graphite Gray, Li-Ion	SUG2388AA
-	Transceiver, C43, Morning Indigo, S. Asia	SUG2303AA
-	Transceiver, C43, Eskimo White, S. Asia	SUG2304AA
-	Transceiver, C43, Smoke Gray, S. Asia	SUG2305AA

Accessories

Table 6. Accessories

Part Description	Part Number
Battery, EMEA, 550 mAh NiMH	SNN5626
Battery, S. Asia, 550 mAh NiMH	SNN5623
Battery, S.Asia, 600mAh Li-Ion	SNN5647
Battery, China, 600 mAh Li-Ion	SNN5648
Battery Charger, Hong Kong	SPN4984A
Battery Charger, China	SPN4985A
Battery Charger, US	SPN4987A
Battery Charger, Europe	SPN4989A
Battery Charger, UK	SPN4990A
Adapter, Euro Plug	SPN4940
Vehicle Power Adapter	SYN7818
Easy-Install Hands Free Car Kit (analog audio)	SYN8597
Headset Ear bud – Silver	AAYN4264A
Lanyard	SYN8392
Belt Clip, Black	SYN8631
Pouch, Leather, Black	MOTFL0074K
Pouch, Black & Light Grey w/ plastic front	MOTFQ0075M
Pouch, Light Blue w/velcro	MOTPT0076M
Pouch, Medium Blue	MOTPT0076M

Related Publications

Motorola Timeport 191 Wireless Phone User Guide, English	9888816L01
Motorola Timeport 190 Wireless Phone User Guide English	9889928L01

Index

A

- accessories
 - part numbers 41
- alert modes 15
- alert transducer
 - removing 24
- antenna, removing and replacing 22

B

- battery
 - function 15
 - gauge 15
 - removing 18

C

- caller ID 7
- Canadian Interference-Causing Equipment regulations 1
- changes
 - product 1
- closed user group 7
- commands, manual test mode 34
- controls 9
- conventions 3
- copyrights
 - computer software 2

D

- disassembly 18
- display animation 8

E

- earpiece speaker, removing and replacing 28
- exploded view diagram 38
- exploded view parts list 39

F

- FCC rules 1
- features 6
 - call diverting 8
 - caller ID 7
 - text entry 7
 - voice recognition 7
 - Wireless Access Protocol (WAP) 7

I

- identification 32
 - international mobile station equipment identity 33
 - mechanical serial number 32
 - product 1
- IMEI 33
- Introduction 1

K

- keypad switch dome array, removing and replacing 30
- keypad, removing and replacing 27

L

- LCD 11
- liquid crystal display (LCD) 11

M

- manual test mode 34
- microphone, removing and replacing 29
- MSN 32

N

- names
 - product 1

O

- overview 6

P

- part numbers
 - accessories 41
- parts 38
 - exploded view diagram 38
 - exploded view parts list 39
- product
 - changes 1
 - identification 1
 - names 1
- publications, related 41

R

- rear escutcheon
 - removing 20
- rear housing
 - removing 20
- regulatory agency compliance 1

PRELIMINARY

related publications 41

removing

- alert transducer 24
- antenna 22
- battery 15
- earpiece speaker 28
- keypad 27
- keypad switch dome array 30
- microphone 29
- rear escutcheon 20
- rear housing 20
- SIM card 19
- transceiver board 25

replacing

- antenna 22
- earpiece speaker 28
- keypad 27
- keypad switch dome array 30
- microphone 29

revisions

- service manual 3

S

serial number

- mechanical 32

service manual

- about 2
- revisions 3
- scope 2

service policy 3

- customer support 4
- out of box failure 3
- product support 3

shut down

- upon battery removal 15

SIM card 32

- removing 19
- replacing 19

support

- customer 4
- product 3

T

test equipment 17

text entry 7

tools 17

transceiver board

- removing 25

troubleshooting 34

- manual test mode 34

- manual test mode commands 34

- troubleshooting chart 35

V

- voice recognition 7

W

- WAP (Wireless Access Protocol) 7

- warranty service 3

- Wireless Access Protocol (WAP) 7

MOTOROLA, the Stylized M Logo, and all other trademarks indicated as such herein are trademarks of Motorola, Inc.

© Reg. U.S. Pat. & Tm. Off.

All other product or service names are the property of their respective owners.

© 2001 Motorola, Inc.

All rights reserved.

Personal Communications Sector,

1500 Gateway Blvd.

Boynton Beach, FL 33426-8292

Printed in U.S.A. 08/01



6881039B15-O