



**MOTOROLA**

Level 1 and 2 Service Manual

6809506A43-O

**MOTOSLVR<sup>™</sup> L7i**

**MOTOSLVR<sup>™</sup> L7e**

# Wireless Telephone



GSM 850/900/1800/1900 MHz GPRS/EDGE

MOTOROLA and the Stylized M Logo are registered in the US Patent & Trademark Office.  
All other product or service names are the property of their respective owners.

The Bluetooth trademarks are owned by their proprietor and used by Motorola, Inc. under license.  
© Motorola, Inc. 2006.  
All rights reserved.

Mobile Devices Business,  
Sawgrass International Concourse  
789 International Parkway  
Room S2C  
Sunrise, FL 33325-6220

---

## Contents

<b>Introduction</b>	<b>5</b>
Product Identification	5
Product Names	5
Regulatory Agency Compliance	5
Computer Program Copyrights	6
About this Service Manual	6
Warranty Service Policy	7
Parts Replacement	7
<b>Specifications</b>	<b>9</b>
<b>Product Overview</b>	<b>11</b>
Features	11
<b>General Operation</b>	<b>13</b>
Controls, Indicators, and Input/Output (I/O) Connectors	13
Battery Function	15
Operation	16
<b>Tools and Test Equipment</b>	<b>17</b>
<b>Disassembly</b>	<b>18</b>
Removing and Replacing the Battery Cover	18
Removing and Replacing the Battery	19
Removing and Replacing the SIM	20
Removing and Replacing the Antenna Cap	21
Removing and Replacing the Transceiver PC Board Shield	22
Removing and Replacing the Transceiver PC Board	24
Removing and Replacing the Camera Assembly	27
Removing and Replacing the Front Housing	29
Removing and Replacing the Keypad	30
Removing and Replacing the Keypad PC Board	31
Removing and Replacing the Antenna	33
Removing and Replacing the Display Module	34
<b>Subscriber Identity Module (SIM) and Identification Label</b>	<b>36</b>
SIM	36
Identification	36
<b>Telephone Identification</b>	<b>38</b>
Identification Label	38
<b>Troubleshooting</b>	<b>39</b>
Manual Test Mode	39
Manual Test Mode Commands	39
Troubleshooting Chart	41
<b>Part Numbers</b>	<b>43</b>
Exploded View Diagram	44
Exploded View Parts List	45
Accessories	46
Related Publications	49
Programming: Software Upgrade and Flexing	49
<b>Index</b>	<b>1</b>



## Introduction

Motorola® Inc. maintains a worldwide organization that is dedicated to provide responsive, full-service customer support. Motorola products are serviced by an international network of company-operated product-care centers as well as authorized independent service firms.

Available on a contract basis, Motorola Inc. offers comprehensive maintenance and installation programs that enable customers to meet requirements for reliable, continuous communications.

To learn more about the wide range of Motorola service programs, contact your local Motorola products representative or the nearest Customer Service Manager.

## Product Identification

Motorola products are identified by the model number on the housing. Use the entire model number when inquiring about the product. Numbers are also assigned to chassis and kits. Use these numbers when requesting information or ordering replacement parts.

## Product Names

Product names are listed on the front cover. Product names are subject to change without notice. Some product names, as well as some frequency bands, are available only in certain markets.

## Regulatory Agency Compliance

This device complies with Part 15 of the FCC Rules. Operation is subject to the following conditions:

- This device may not cause any harmful interference, and
- must accept interference received, including interference that may cause undesired operation.

This class B device also complies with all requirements of the Canadian Interference-Causing Equipment Regulations (ICES-003).

Cet appareil numérique de la classe B respecte toutes les exigences du Règlement sur le matériel brouilleur du Canada.

## Computer Program Copyrights

The Motorola products described in this manual may include Motorola computer programs stored in semiconductor memories or other media that are copyrighted with all rights reserved worldwide to Motorola. Laws in the United States and other countries preserve for Motorola, Inc. certain exclusive rights to the copyrighted computer programs, including the exclusive right to copy, reproduce, modify, decompile, disassemble, and reverse-engineer the Motorola computer programs in any manner or form without Motorola's prior written consent. Furthermore, the purchase of Motorola products shall not be deemed to grant either directly or by implication, estoppel, or otherwise, any license or rights under the copyrights, patents, or patent applications of Motorola, except for a nonexclusive license to use the Motorola product and the Motorola computer programs with the Motorola product.

## About this Service Manual

Using this service manual and the suggestions contained in it assures proper installation, operation, and maintenance of wireless telephones. Refer questions about this manual to the nearest Customer Service Manager.

### Audience

This manual aids service personnel in testing and repairing of wireless telephones. Service personnel should be familiar with electronic assembly, testing, and troubleshooting methods, and with the operation and use of associated test equipment.

Use of this manual assures proper installation, operation, and maintenance of Motorola products and equipment. It contains all service information required for the equipment described and is current as of the printing date.

### Scope

The scope of this manual is to provide basic information relating to wireless telephones, and provide procedures and processes for repairing the phones at Level 1 and 2 service centers including:

- Unit swap out
- Repairing of mechanical faults
- Basic modular troubleshooting
- Testing and verification of phone functionality
- Initiate warranty claims and send faulty modules to Level 3 or 4 repair centers

---

## Conventions

Special characters and typefaces, listed and described below, are used in this manual to emphasize certain types of information.



*Note: Emphasizes additional information pertinent to the subject matter.*



*Caution: Emphasizes information about actions that may result in equipment damage.*



*Warning: Emphasizes information about actions that may result in personal injury.*



Keys to be pressed are represented graphically. For example, instead of “Press the End key”, you will see “Press ”.

## Warranty Service Policy

This product is sold with the standard 12-month warranty terms and conditions. Accidental damage, misuse, and extended warranties offered by retailers are not supported under warranty. Non-warranty repairs are available at agreed fixed repair prices.

### Out of Box Failure Policy

The standard out of box failure criteria applies. Customer phones that fail very early on after the date of sale, are to be returned to Manufacturing for root-cause analysis, to guard against epidemic criteria. Manufacturing will bear the costs of early life failure.

### Product Support

Customer's original phone will be repaired but not refurbished as standard. Appointed Motorola Service Hubs will perform warranty and non-warranty field service for level 2 (assemblies) and level 3 (limited PCB component). The Motorola High Technology Centers will perform level 4 (full component) repairs.

### Customer Support

Customer support is available through dedicated Call Centers and in-country help desks. Product Service training should be arranged through the local Motorola Support Center.

## Parts Replacement

When ordering replacement parts or equipment, include the Motorola part number and description used in the service manual.

When the Motorola part number of a component is not known, use the product model number or other related major assembly along with a description of the related

major assembly and of the component in question.

In the U.S.A., to contact Motorola, Inc. on your TTY, call: 800-793-7834.

### **Replacement Parts Service Division (RPSD)**

Order replacement parts, test equipment, and manuals from RPSD.

#### **U.S.A.**

Phone: 800-422-4210

FAX: 800-622-6210

Website: <http://businessonline.motorola.com>

#### **Outside U.S.A.**

Phone: 847-538-8023

FAX: 847-576-3023

#### **EMEA**

Phone: +49 461 803 1404

Website: <http://emeaonline.motorola.com>

#### **Asia**

Phone: +65 648 62995

Website: <http://asiaonline.motorola.com>



## Specifications

General Function	Specification
Frequency Range GSM 850	824-849 MHz Tx 869-894 MHz Rx
Frequency Range GSM 900	880-915 MHz Tx (with EGSM) 925-960 MHz Rx
Frequency Range DCS 1800	1710-1785 MHz Tx 1805-1880 MHz Rx
Frequency Range PCS 1900	1850-1910 MHz Tx 1930-1990 MHz Rx
Channel Spacing	200 kHz
Channels	174 EGSM, 374 DCS, 374 PCS, 124 GSM 850 carriers with 8 channels per carrier
Modulation	GMSK at BT = 0.3
Transmitter Phase Accuracy	5 Degrees RMS, 20 Degrees peak
Duplex Spacing	45 MHz
Frequency Stability	± 0.10 ppm of the downlink frequency (Rx)
Operating Voltage	+3.3V dc to +4.2V dc (battery) +4 V dc to +5.6V dc (external connector)
Transmit Current Drain	90~280 mA average talk current drain
Stand-by Current drain	3.2 mA (DRX2), 2.2 mA (DXR9) typical
Temperature Range	-10° C to +55° C (+15° F to +130° F)
Dimensions, with 840 mAh Li Ion battery	113.5mm x 49mm x 11.5mm (4.6 inches x 1.9 inches x 0.4 inches)
Size (Volume)	59 cc (3.6 in <sup>3</sup> ), with battery
Weight	96 grams (3.3 oz), with battery
Battery Life, with standard 900 mAh Li-Ion Battery	Talk time 210 to 400 minutes Standby time 180 to 350 hours  All talk and standby times are approximate and depend on network configuration, signal strength, and features selected. Standby times are quoted as a range from DRX=2 to DRX=9. Talk times are quoted as a range from DTX off to DTX on.
Battery Charge Time	4 hours to 90% of 900 mAh capacity
Alert volume	Max 95 dB @5cm, 0.5 Watts input

Transmitter Function	Specification
RF Power Output	32 dBm nominal GSM 850/900 29 dBm nominal GSM 1800/1900
Output Impedance	50 ohms nominal
Spurious Emissions	-36 dBm from 0.1 to 1 GHz, -30 dBm from 1 to 4 GHz

Receiver Function	Specification
Receive Sensitivity	Better than -105 dBm
RX Bit Error Rate (100k bits) Type II	< 2%

Speech Coding Function	Specification
Speech Coding Type	Regular pulse excitation/linear predictive coding with long term prediction (RPE LPC with LTP)
Bit Rate	13.0 kbps

Speech Coding Function	Specification
Frame Duration	20 ms
Block Length	260 bits
Classes	Class 1 bits = 182 bits; Class 2 bits = 78 bits
Bit Rate with FEC Encoding	22.8 kbps

---

## Product Overview

MotoSLVR L7i/ L7e mobile telephones feature Global System for Mobile communication (GSM) technology. The mobile telephone uses a simplified icon and Graphical User Interface (GUI) for easier operation, allow Short Message Service (SMS) text messaging, and include clock, alarm, datebook, and calculator personal management tools. The telephones feature VibraCall vibrating alert and a selection of ring tones. The MotoSLVR L7i/ L7e is a quad-band phone that allows roaming within the 850, 900, 1800 and 1900MHz bands.

MotoSLVR L7i/ L7e telephones support EDGE/GPRS and SMS in addition to traditional circuit switched transport technologies.

The telephones are made of polycarbonate plastic with a metal enclosure. The display, camera, speaker, the 22-key keypad, transceiver Printed-circuit Board (PCB), microphone, charger, headphone connectors, and power button are contained within the candy bar form-factor housing. The 900 mAh Lithium Ion (Li-Ion) battery provides up to 400 minutes of talk time with up to 350 hours of standby time<sup>1</sup>. These telephones feature a 176 x 220 pixel display.

## Features

The MotoSLVR L7i/ L7e telephones use advanced, self-contained, sealed, custom integrated circuits to perform the complex functions required for GSM communication. Aside from the space and weight advantage, microcircuits enhance basic reliability, simplify maintenance, and provide a variety of operational functions.

Features available in the MotoSLVR L7i/ L7e telephone include:

- Large 176 x 220 TFT display with 262K colors
- 1.3 Megapixel Camera 8x zoom,
- Video capture (15fps) and full screen video playback (15fps)
- Music player with MP3 and AAC support
- Bluetooth Class 2
- Software Skinning
- SyncML Device Management (Sync ML DM)
- Downloadable: Java apps, wallpaper, screensaver, ring tones (Midi/MP3)
- Integrated hands free speakerphone
- GPRS Class 10
- EDGE Class 10
- Push to Talk over cellular with GPRS
- SCREEN3 (Motorola/4th Pass server)
- Email POP3 & IMAP4
- 20MB internal memory

Upon receipt of a call, the calling party's phone number is compared to the phonebook. If the number matches a phonebook entry, that name displays. If there

---

1. All talk and standby times are approximate and depend on network configuration, signal strength, and features selected. Standby times are quoted as a range from DRX=2 to DRX=9. Talk times are quoted as a range from DTX off to DTX on.

is no phonebook entry, the incoming phone number displays. If no caller identification information is available, an incoming call message displays.



*User must subscribe to a caller line identification service through their service provider.*

### **Personal Information Management**

The MotoSLVR L7i/ L7e telephones contain a built-in datebook with alarm reminders, message center, and a phonebook.

### **Other Features**

Detailed descriptions of other features available for the MotoSLVR L7i/ L7e wireless telephones are in the appropriate User's Guide listed in the Related Publications section toward the end of this manual.



*L7i is the name used for this phone in the High Growth Markets (HGM), North Asia & Latin America regions. L7e is the name used for this phone in the Europe region.*

# General Operation

## Controls, Indicators, and Input/Output (I/O) Connectors

The telephones' controls are on the front of the device and on the keyboard as shown in Figure 1. Indicator icons are displayed on the LCD (see Figure 2).



061507o

**Figure 1. Controls and Indicators**

### Liquid Crystal Display (LCD)

MotoSLVR L7i/ L7e phones feature a 176 x 220 262k TFT color display offering 7 lines of text, 1 line of icons, and 1 line of prompts. The display provides constant graphical representations of battery capacity and signal strength, as well as the real-time clock.



*Whether a phone displays all indicators depends on the programming and services to which the user subscribes.*

Figure 2 shows common icons displayed on the LCD.

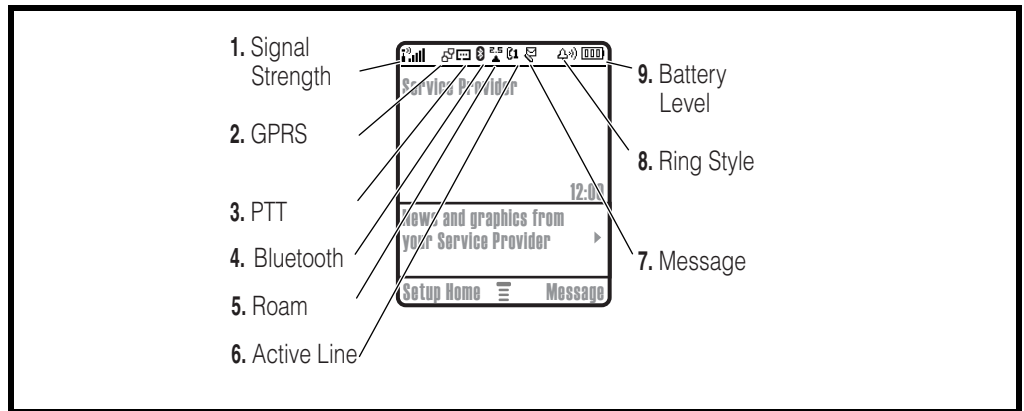

050206o

**Figure 2. Display Idle Screen**

**1 Signal Strength Indicator** – Vertical bars show the strength of the network connection. You can't make or receive calls when  $\Upsilon$  or  $\Upsilon\emptyset$  appears.

**2 EDGE/GPRS Indicator** – Shows when your phone is using a high-speed Enhanced Data for GSM Evolution (EDGE) or General Packet Radio Service (GPRS) network connection. Indicators can include:

- GPRS PDP context active
- EDGE
- GPRS packet data available

**3 Data Indicator** – Shows connection status.

- secure packet data transfer
- unsecure packet data transfer
- secure application connection
- unsecure application connection
- secure Circuit Switch Data (CSD) call
- unsecure CSD call
- Bluetooth™ connection is active

**4 Roam Indicator** – Shows  $\blacktriangle$  when your phone is seeking or using a network outside your home network.

**5 Active Line Indicator** – Shows  $\text{☎1}$  to indicate an active call, or  $\text{☎}$  to indicate when call forwarding is on. Indicators for dual-line-enabled SIM cards can include:

- $\text{☎1}$  line 1 active
- $\text{☎}$  line 1 active, call forward on
- $\text{☎2}$  line 2 active
- $\text{☎}$  line 2 active, call forward on

**6 Messaging Presence Indicator** – Shows when Instant Messaging (IM) is active. Indicators can include:

- |   |   |
|---|---|
|  IM active |  invisible to IM |
|  busy      |  offline         |

When a Java™ application is active,  can show here.

If you set a reminder for a datebook event,  can show here.

**7 Message Indicator** – Shows when you receive a new message. Indicators can include:

- |  |   |
|--|---|
|  text message         |  voice message |
|  voice & text message |   |
|  IM message           |   |

**8 Ring Style Indicator** – Shows the ring style setting.

- |  |  |
|--|--|
|  loud ring  |  vibrate & ring     |
|  soft ring |  vibrate then ring |
|  vibrate  |  silent           |

**9 Battery Level Indicator** – Vertical bars show the battery charge level. Recharge the battery when your display shows Low Battery.

## Battery Function

### Battery Charge Indicator

The telephone displays a battery charge indicator icon in the idle screen to indicate the battery charge level. The gauge shows 4 levels: 100%, 50%, 20%, and low battery.

### Battery Removal

Removing the battery causes the phone to shut down immediately and lose any pending work. For example, (partially entered phonebook entries or outgoing messages).



*All batteries can cause property damage and / or bodily injury such as burns if a conductive material such as jewelry, keys, or beaded chains touch exposed terminals. The conductive material may complete an electrical circuit (short circuit) and become quite hot. Exercise care when handling any charged battery, particularly when placing it inside a pocket, purse, or other container with metal objects.*



*If the battery is removed while receiving a message, the message is lost.*



*To ensure proper memory retention, turn the phone OFF before removing the battery. Immediately replace the old battery with a fresh battery.*

## Operation

For detailed operating instructions, refer to the appropriate User's Guide listed in the Related Publications section toward the end of this manual.



## Tools and Test Equipment

This section describes how to disassemble MotoSLVR L7i/ L7e telephones. Table 1 lists the tools and test equipment used. Use either the listed items or equivalents.

**Table 1. General Test Equipment and Tools**

Motorola Part Number <sup>1</sup>	Description	Application
See Table 6.	Charger	Used to charge battery and power phone.
0180386A82	Antistatic Mat Kit (includes 66-80387A95 antistatic mat, 66-80334B36 ground cord, and 42-80385A59 wrist band)	Provides protection from damage to phone caused by electrostatic discharge (ESD).
6680388B67	Disassembly Tool, plastic with flat and pointed ends (manual opening tool)	Used during assembly/disassembly.
6680388B01	Tweezers, plastic	Used during assembly/disassembly.
RSX4043-A	Torque Driver	Used to remove and replace screws.
—	Torque Driver Bits T3, and T6 Plus, Apex 440-5IP Torx Plus or equivalent	Used with torque driver.
HP34401A <sup>2</sup>	Digital Multimeter	Used to measure battery voltage.
W.FL-LP-IN	Coaxial cable connector removal tool	Used to attach or remove coaxial cable connector to/from circuit board.

1. To order in North America, contact Motorola Aftermarket and Accessories Division (AAD) by phone at (800) 422-4210 or FAX (800) 622-6210; Internationally, you can reach AAD by phone at (847) 538-8023 FAX (847) 576-3023.

2. Not available from Motorola. To order, contact Hewlett Packard at (800) 452-4844.

## Disassembly

This section describes how to disassemble MotoSLVR L7i/ L7e telephones. Tools and equipment used are listed in Table 1.



*Many of the integrated devices used in this phone are vulnerable to damage from ESD. Ensure adequate static protection is in place when handling, shipping, and servicing any internal components.*



*Avoid stressing the plastic in any way to avoid damage to either the plastic or internal components.*

### Removing and Replacing the Battery Cover

1. Ensure the phone is turned off.
2. Press the battery cover latch at the top of the phone, and lift the battery cover up from the phone and lift it off (see Figure 3).



061492o

**Figure 3. Removing the Battery Cover**

3. To replace, align the battery cover with the rear housing.
4. Place the battery cover on the rear housing and gently press the battery cover until it snaps into place. Ensure that the battery door tap is tucked in below the RF cover.

## Removing and Replacing the Battery

1. Remove the battery cover as described in the procedures.
2. Lift the top end of the battery as indicated by the arrow in Figure 4.
3. Lift the battery up and out of the battery compartment.

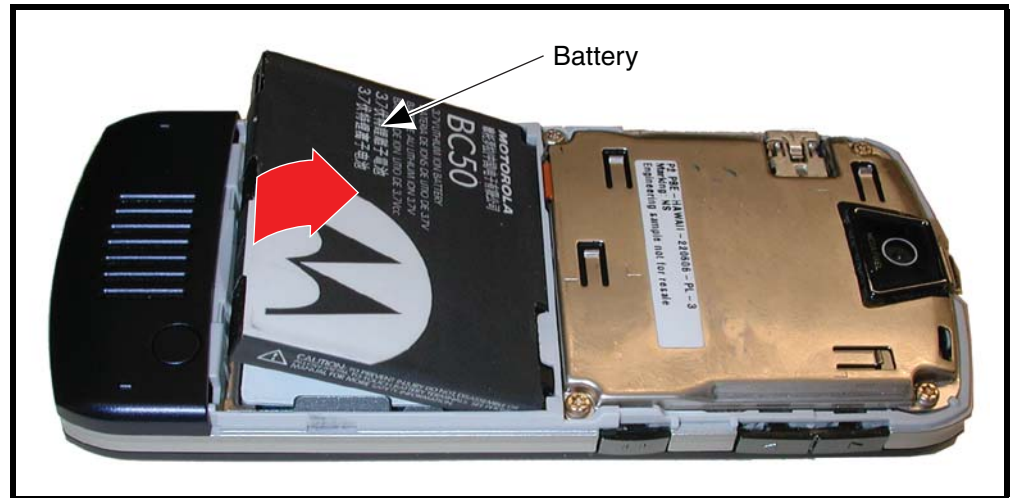

0614930

Figure 4. Removing and Replacing the Battery



*There is a danger of explosion if the Lithium-Ion battery is replaced incorrectly. Replace only with the same type of battery or equivalent as recommended by the battery manufacturer. Dispose of used batteries according to the manufacturer's instructions.*

4. To replace, insert the bottom of the battery into the battery compartment with contacts facing downward.
5. Press the top of the battery into the battery compartment.
6. Replace the battery cover as described in the procedures.

## Removing and Replacing the SIM

1. Remove the battery cover and battery as described in the procedures.
2. Unlock the SIM holder by sliding it away from the SIM.
3. Lift up the SIM and remove it from the phone (see Figure 5).

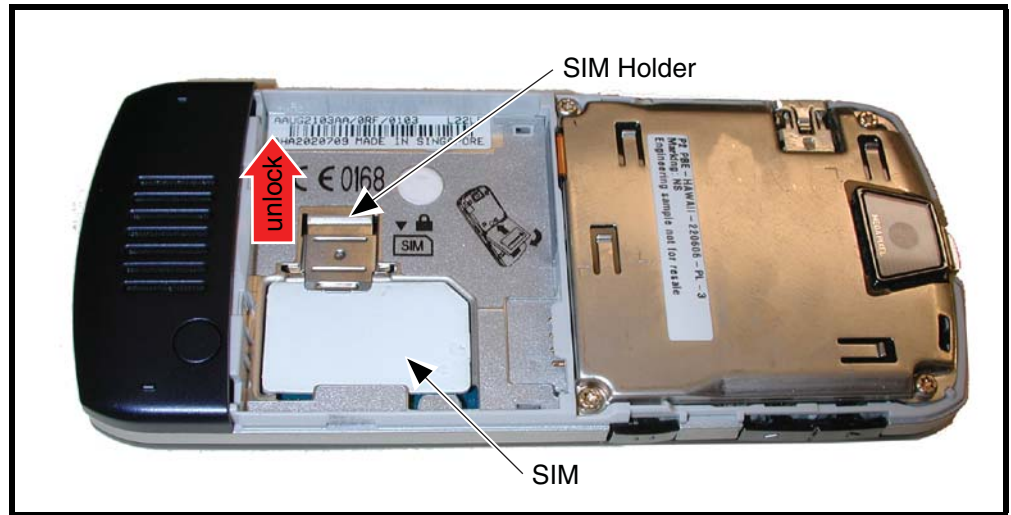

0614950

**Figure 5. Removing and Replacing the SIM**

4. To replace, slide the SIM into the SIM holder with the notched corner located as shown.
5. Lock the SIM holder by sliding it toward the SIM.
6. Reassemble the battery and battery cover as described in the procedures.

## Removing and Replacing the Antenna Cap

1. Remove the battery cover, battery and SIM, as described in the procedures.
2. Insert the disassembly tool under each side of the antenna cover to release the antenna cover latches (see Figure 9).

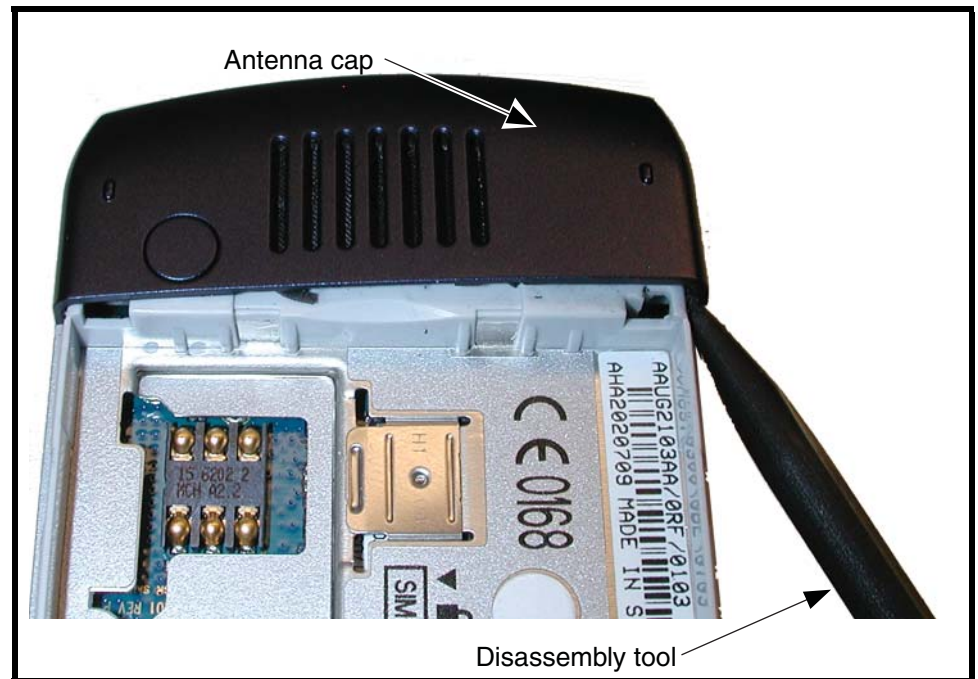

Figure 6. Removing the Antenna Cap

0614960

3. Carefully lift the antenna cap away from the phone.
4. To replace, align the antenna cap over the antenna.
5. Place the curved edge of the antenna cap onto the phone.
6. Carefully press the straight edge of the antenna cap into place until the latches snap into place.
7. Reassemble the SIM, battery, and battery cover as described in the procedures.

## Removing and Replacing the Transceiver PC Board Shield

1. Remove the battery cover, battery, SIM, and antenna, as described in the procedures.
2. Using a Torx Plus driver with a T6 bit, remove the 6 housing screws from the phone. Set the screws aside for re-use (see Figure 7).

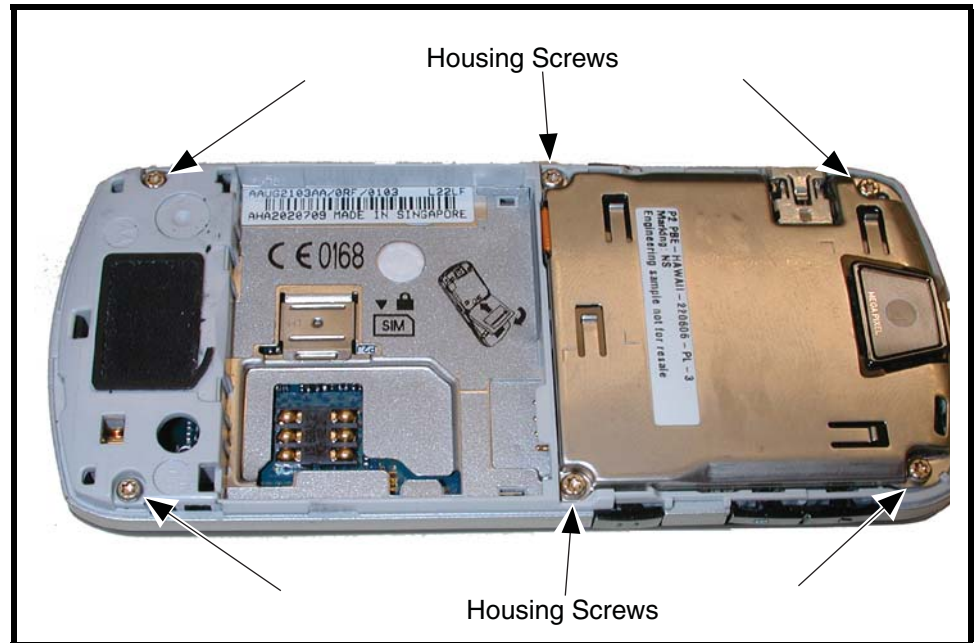

0614970

Figure 7. Removing and Replacing the Rear Housing Screws.

3. Lift the PCB shield away from the phone.

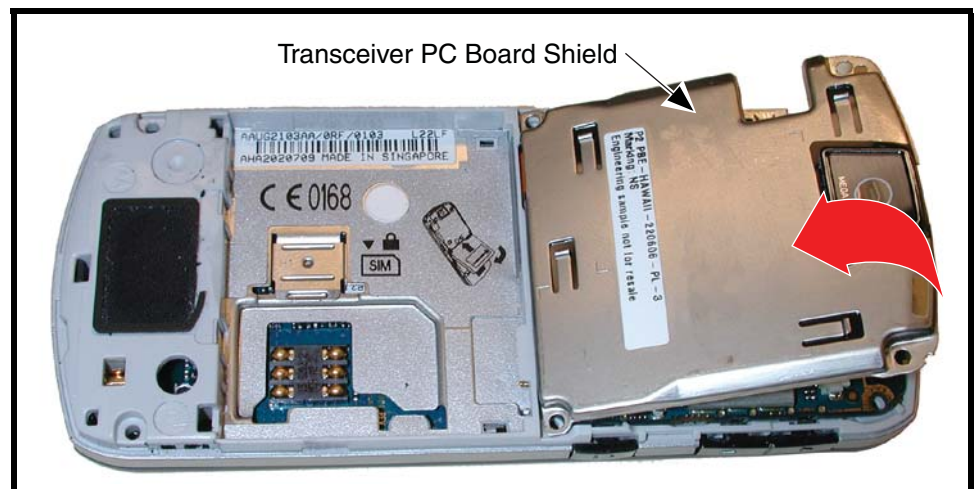

0614980

Figure 8. Removing and Replacing the Transceiver PC Board Shield.

4. To replace, place the PC board shield onto the phone. Ensure the PCB and PCB shield are aligned with the chassis alignment pin.
5. Insert and tighten the 6 T6 screws to a torque setting of 14 Ncm. Do not overtighten.
6. Reassemble the antenna cap, SIM, battery and battery cover as described in the procedures.

## Removing and Replacing the Transceiver PC Board

1. Remove the battery cover, battery, SIM, and rear housing as described in the procedures..



*This product contains static-sensitive devices. Use anti-static handling procedures to prevent ESD and component damage.*



*The flexible printed cable (FPC) (flex) is easily damaged. Exercise extreme care when handling.*

2. Insert the flat end of the disassembly tool under the keypad PC board flex connector to unseat it from the transceiver PC board (see Figure 9).

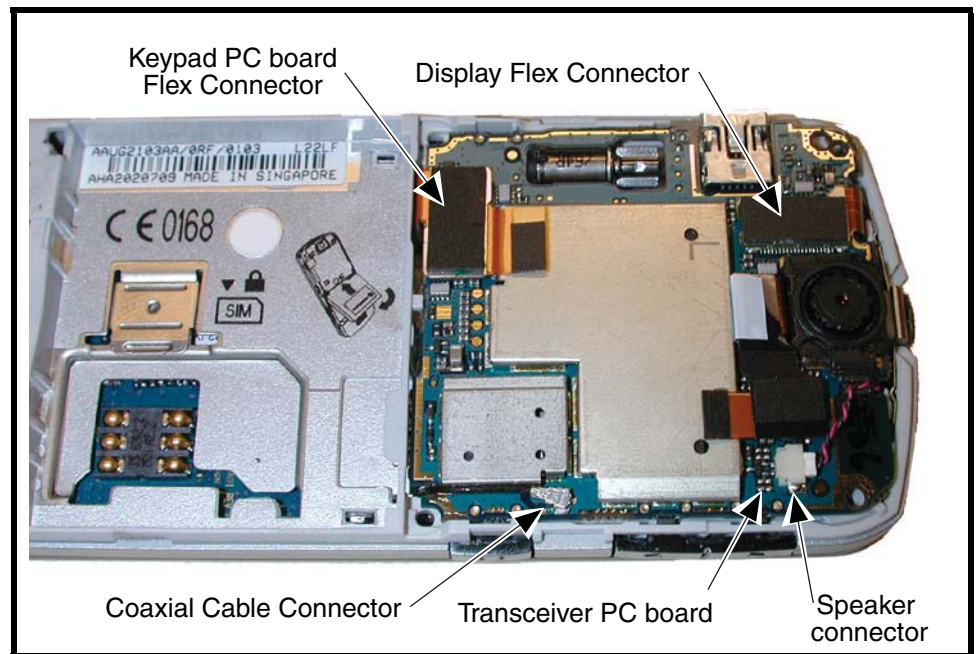

0614990

**Figure 9. Removing the Transceiver PC Board Connectors**

3. Unseat the display flex connector with the flat edge of the disassembly tool (see Figure 9).
4. Use the metal tweezers to remove the speaker connector plug from its socket (see Figure 9).



5. Use the coaxial cable extraction tool (see Figure 12) to unseat the coaxial cable connector from the transceiver PC board (see Figure 13)..

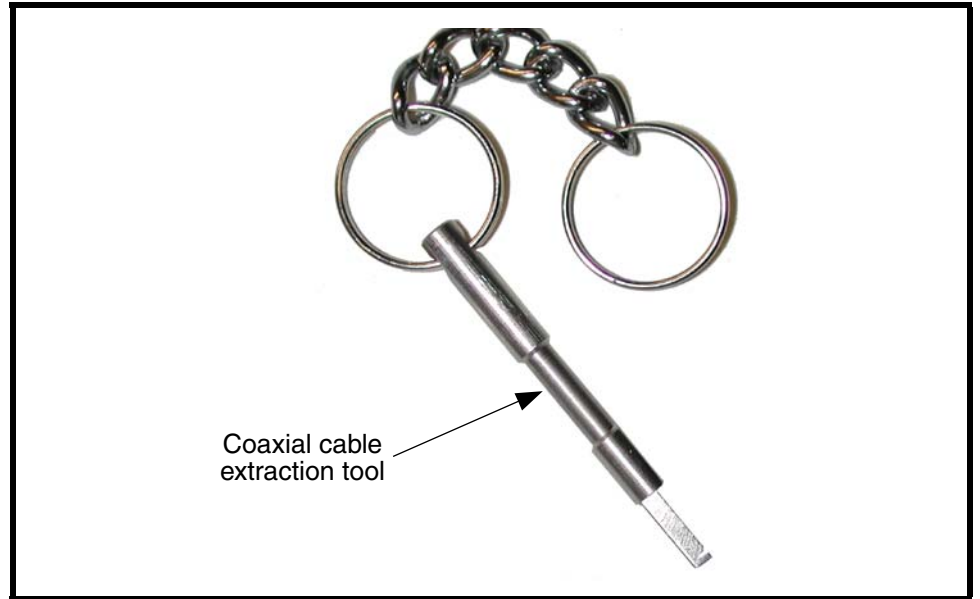

051259o

Figure 10. Coaxial Cable Extraction Tool

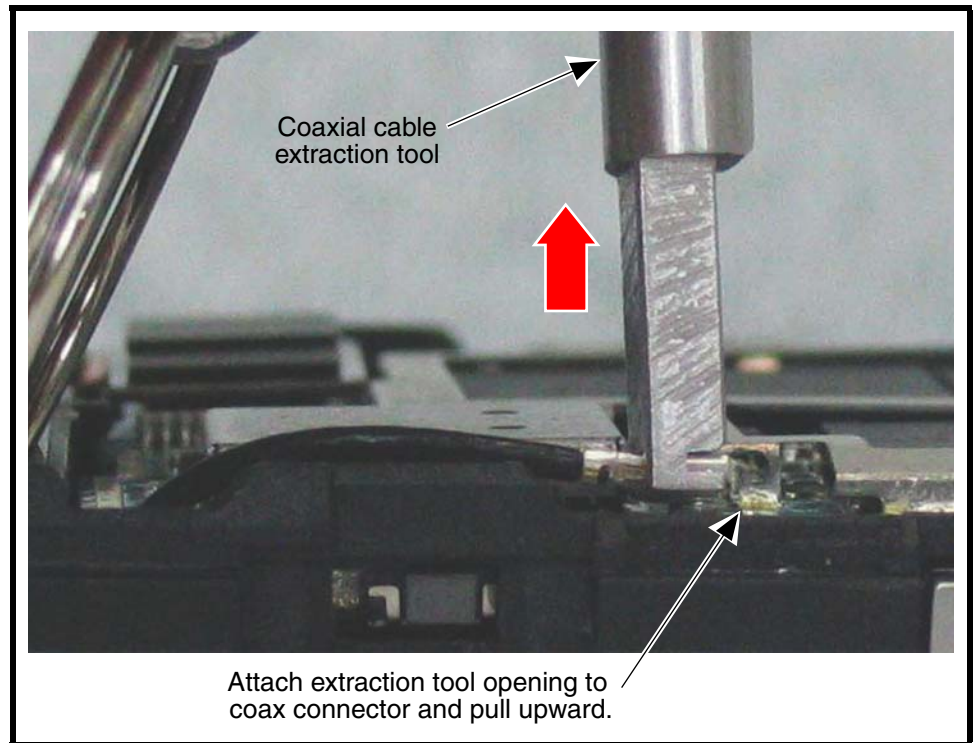

051260o

Figure 11. Coaxial Cable Extraction Tool

6. Use the disassembly tool to unseat the keypad PC board flex connector from its socket on the Transceiver PC board (see Figure 9)
7. Carefully lift one side of the transceiver PC board out of the phone. Be careful to avoid damage to the two flex cables and the coaxial cable.
8. Lift the transceiver PC board completely out of the phone.
9. To replace, carefully insert the side edge of the transceiver PC board into the phone chassis. Avoid damaging the battery pogo pins.
10. Carefully re-attach the display flex connector, the main flex connector, and the coaxial cable, to the transceiver PC board. Ensure the coaxial connector is positioned on the slot.
11. Reassemble the transceiver PC board shield, antenna cap, SIM, battery and battery cover as described in the procedures.

## Removing and Replacing the Camera Assembly

1. Remove the battery cover, battery, SIM, antenna, and transceiver PC board as described in the procedures..



*This product contains static-sensitive devices. Use anti-static handling procedures to prevent ESD and component damage.*



*The flexible printed cable (FPC) (flex) is easily damaged. Exercise extreme care when handling.*

2. Use the disassembly tool to unseat the camera assembly flex connector from the transceiver PC board assembly (see Figure 12).

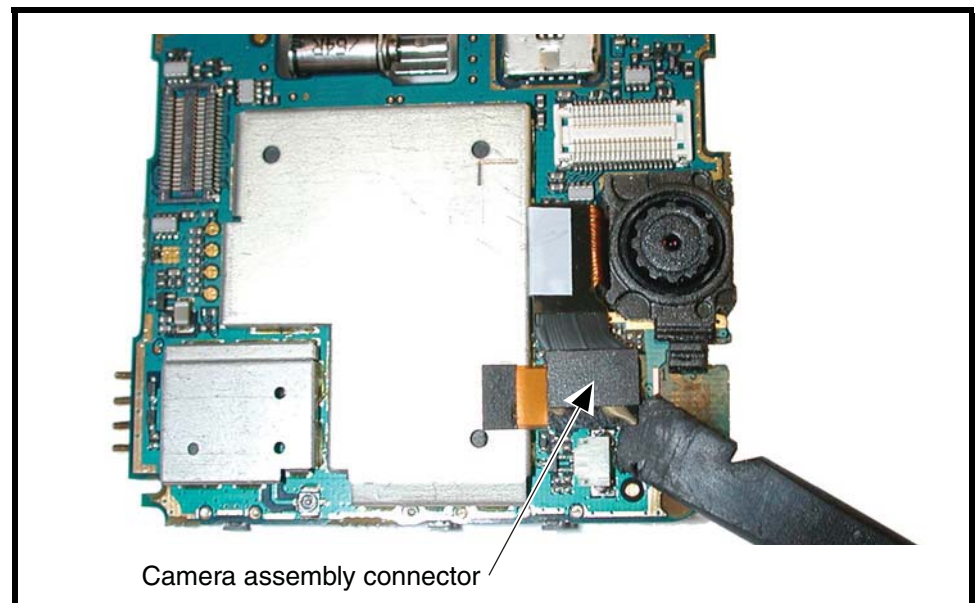

**Figure 12. Removing the Camera Assembly Connector**

3. Lift the camera assembly away from the transceiver PC board (see Figure 13).

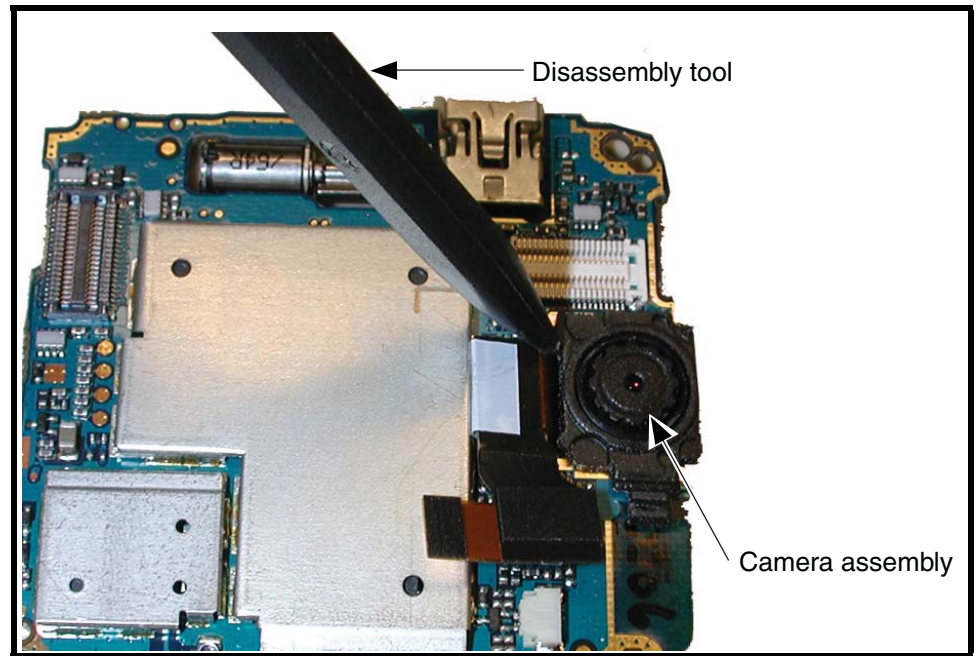

061504o

**Figure 13. Removing the Camera Assembly**

4. Remove the rubber grommet from the camera assembly.
5. To replace, place the rubber camera assembly grommet onto the camera assembly. Ensure the flat side of the grommet is facing away from the flex connector.
6. Align the camera assembly to the transceiver PC board.
7. Slide the camera assembly into its slot on the transceiver PC board. Ensure that the flat side of the camera grommet lines up with the outer edge of the PC board.
8. Carefully press the camera flex connector into its socket on the transceiver PC board.
9. Reassemble the transceiver PC board, transceiver PC board shield, antenna cap, SIM, battery and battery cover as described in the procedures.

---

## Removing and Replacing the Front Housing

1. Remove the battery cover, battery, SIM, antenna, and transceiver PC board as described in the procedures.
2. Insert the disassembly tool between the front housing and the chassis assembly (see Figure 14).



0615050

**Figure 14. Releasing the Front Housing Catches**

3. Slide the disassembly tool around the phone between the front housing and the phone to release the housing catches along the sides of the front housing (see Figure 14).
4. Carefully lift and remove the front housing from the phone.
5. To replace, align the front housing to the phone.
6. Lower the phone onto the front housing and keypad.
7. Carefully and gently press the front housing into the chassis until all of the housing catches are engaged.
8. Reassemble the transceiver PC board, transceiver PC board shield, antenna cap, SIM, battery and battery cover as described in the procedures.

## Removing and Replacing the Keypad

1. Remove the battery cover, battery, SIM, rear housing, and transceiver PC board, as described in the procedures.
2. Lift the keypad up from one corner as shown in Figure 15 and remove it from the front housing.

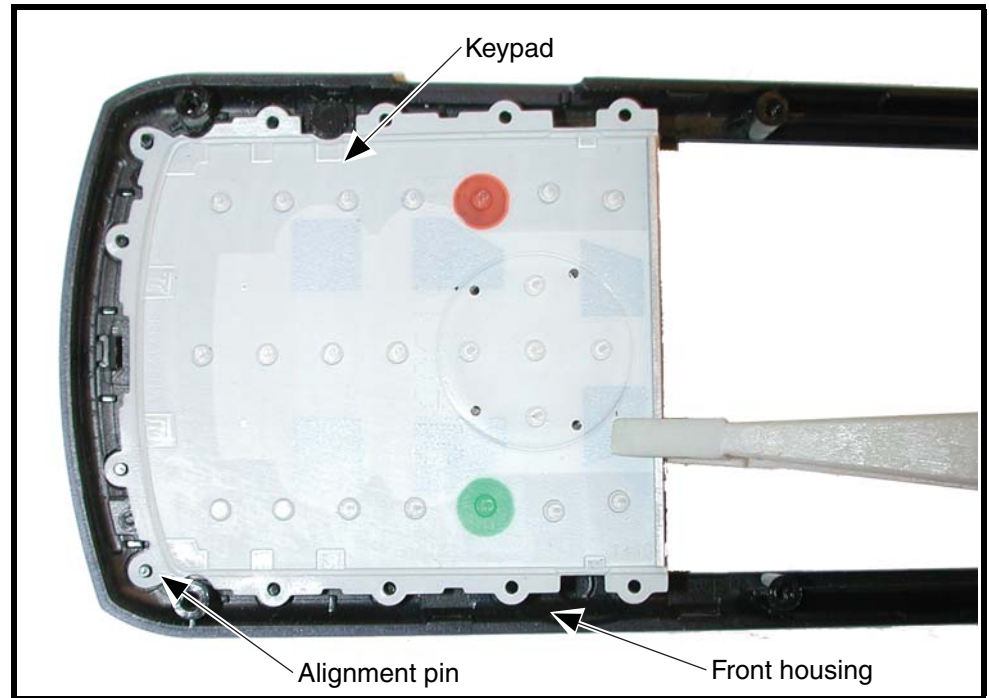
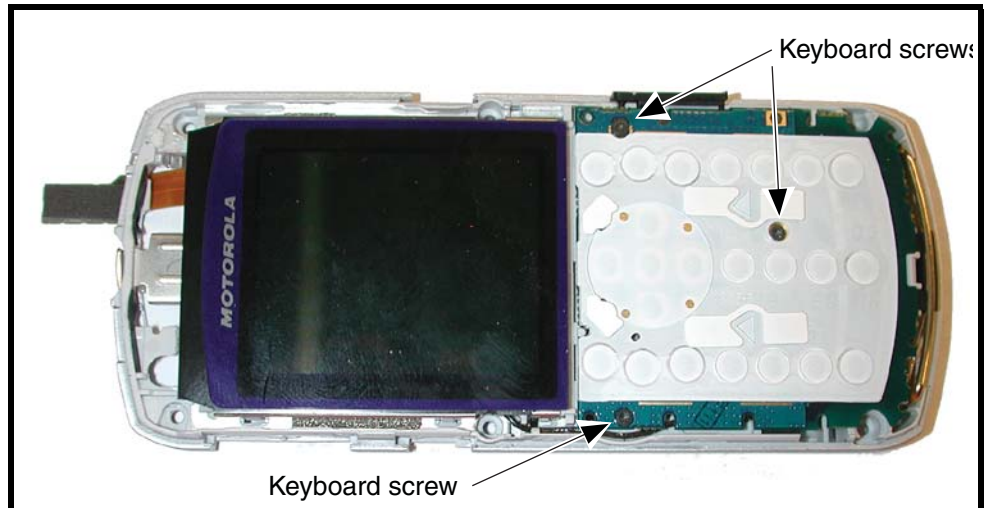

**Figure 15. Removing and Replacing the Keypad**

3. To replace, align the keypad holes with the front housing pins and place the keypad onto the front housing.
4. Reassemble the front housing, transceiver PC board, transceiver PC board shield, antenna cap, SIM, battery and battery cover as described in the procedures.

## Removing and Replacing the Keypad PC Board

1. Remove the battery cover, battery, SIM, antenna, transceiver PC board, and front housing, as described in the procedures.
2. Use the Torx driver with a T3 bit to remove the 3 screws from the Keypad PC board (see Figure 16).



0616160

**Figure 16. Removing the Keypad PC Board Screws**

3. Rotate the end of the PC board up and disconnect the flex connector underneath the keypad PC board (see Figure 17).

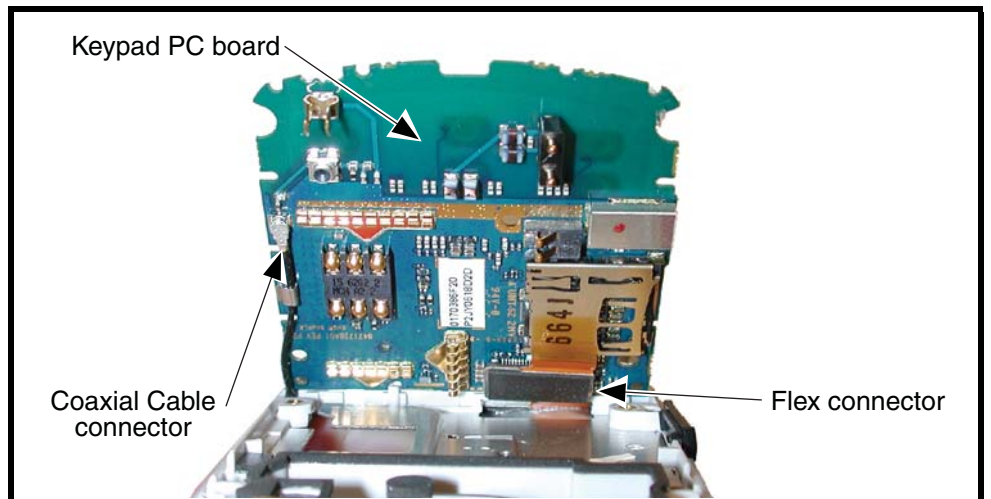

0615440

**Figure 17. Removing the Keypad PC Board Flex Connector**

4. Use the coaxial cable extraction tool to disconnect the coaxial cable connector from the PC board and move the coaxial cable away from the PC board.
5. Remove the silver colored chassis seal.

6. Remove the flex from the chassis.
7. Left the keypad PC board away from the phone.
8. To replace, align the flex connector the keypad PC board and gently press the connector until properly seated in the connector socket.
9. Thread the coaxial cable around the cable guide and seat the connector onto its socket on the keypad PC board.
10. Insert and tighten the 2 T3 screws.
11. Paste on the silver chassis seal.
12. Reassemble the front housing, transceiver PC board, transceiver PC board shield, antenna cap, SIM, battery and battery cover as described in the procedures.



## Removing and Replacing the Antenna

1. Remove the battery cover, battery and SIM, as described in the procedures.
2. Use the plastic tweezers to lift the antenna assembly out of the phone (see Figure 18).

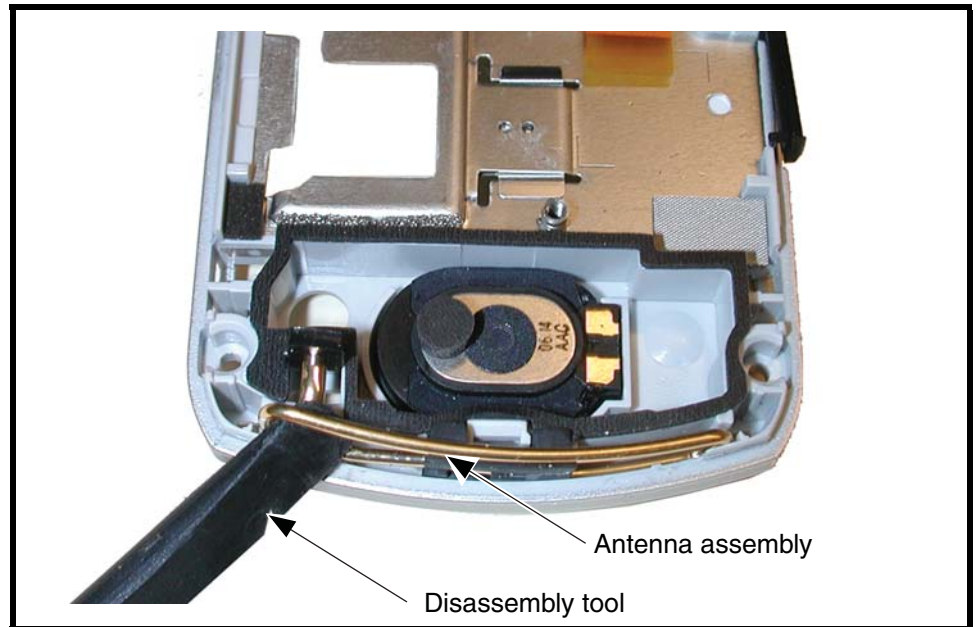

0616180

**Figure 18. Removing and Replacing the Antenna**

3. Carefully remove the antenna from the phone.
4. To replace, insert the antenna into the antenna slot on the phone. Ensure the antenna makes contact with the RF contacts on the PC board.
5. Reassemble the keypad PC board, keypad, front housing, transceiver PC board, transceiver PC board shield, antenna cap, SIM, battery and battery cover as described in the procedures.

## Removing and Replacing the Display Module

1. Remove the battery cover, battery, rear housing, and transceiver PC board as described in the procedures.
2. Turn over the chassis assembly and use the metal tweezers to release the six display bracket latches located under the chassis assembly (see Figure 19).

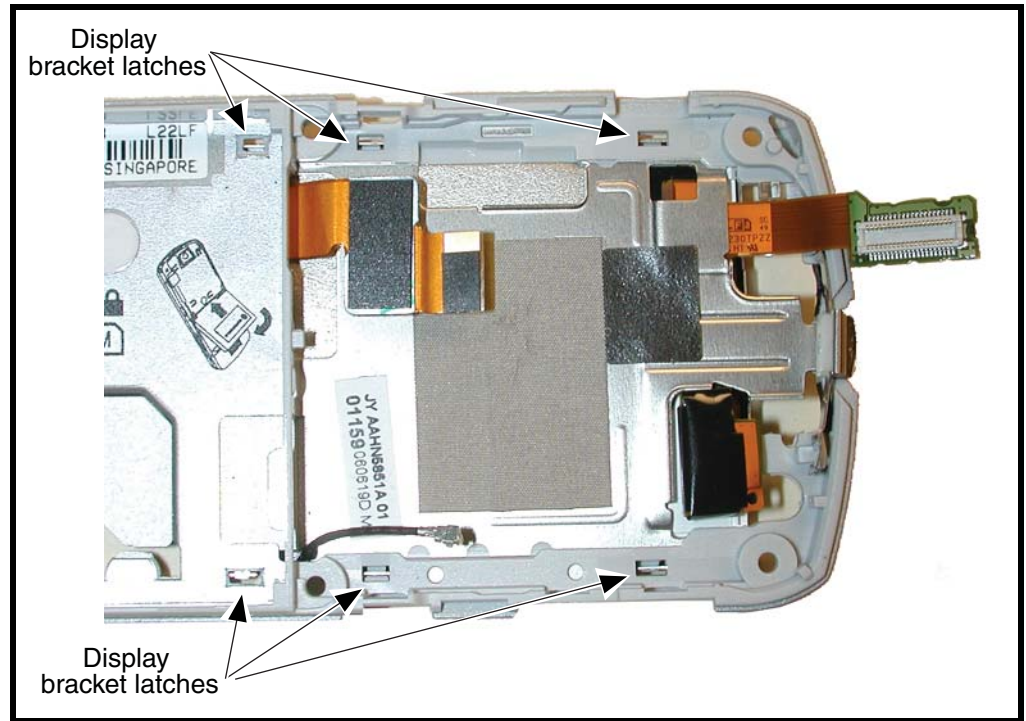

0616190

Figure 19. Removing the Display Module Latches

3. Turn the chassis assembly over and lift the top edge of the display module (see Figure 20).

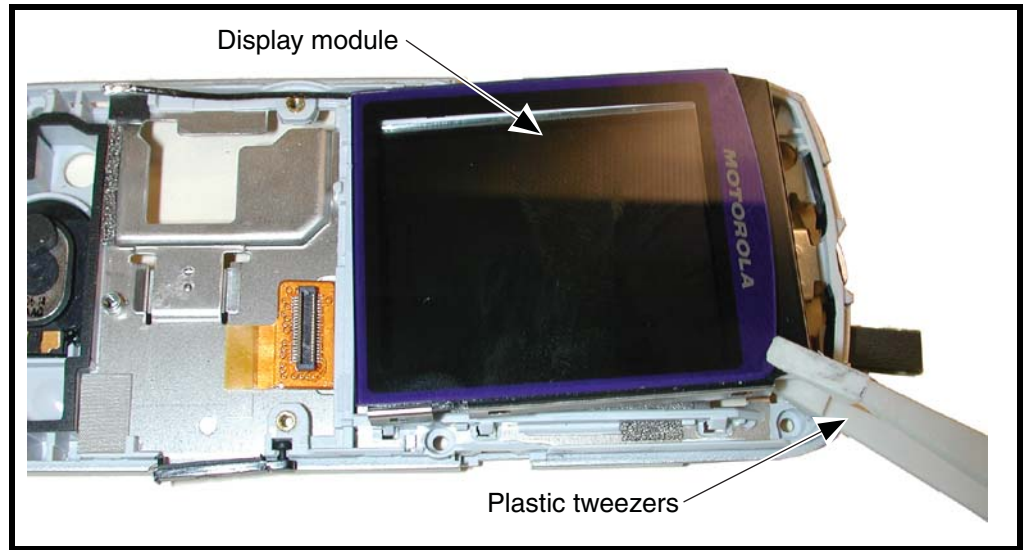

0616200

**Figure 20. Removing the Display Module**

4. Carefully thread the display flex cable through the slot in the chassis assembly and lift the display module away from the chassis.
5. To replace, align the display module to the chassis assembly.
6. Hold the side of the display module near the flex cable away from the chassis assembly.
7. Carefully thread the display flex connector through the opening on the chassis assembly.
8. Lower the display module fully onto the chassis assembly and gently press it into place.
9. Reassemble the antenna, keypad PC board, keypad, front housing, transceiver PC board, transceiver PC board shield, antenna cap, SIM, battery and battery cover as described in the procedures.

## Subscriber Identity Module (SIM) and Identification Label

### SIM

A SIM is required to access the existing local GSM network, or remote networks when traveling (if a roaming agreement has been made with the provider).

The SIM card contains:

- All the data necessary to access GSM services
- The ability to store user information such as phone numbers
- All information required by the network provider to provide access to the network

### Identification

Each Motorola GSM phone is labeled with a variety of identifying numbers. The following information describes the current identifying labels.

#### Mechanical Serial Number (MSN)

The MSN is an individual unit identity number and remains with the unit throughout its life.

The MSN can be used to log and track a phone on Motorola's Service Center Database.

The MSN is divided into 4 sections as shown in Figure 21.

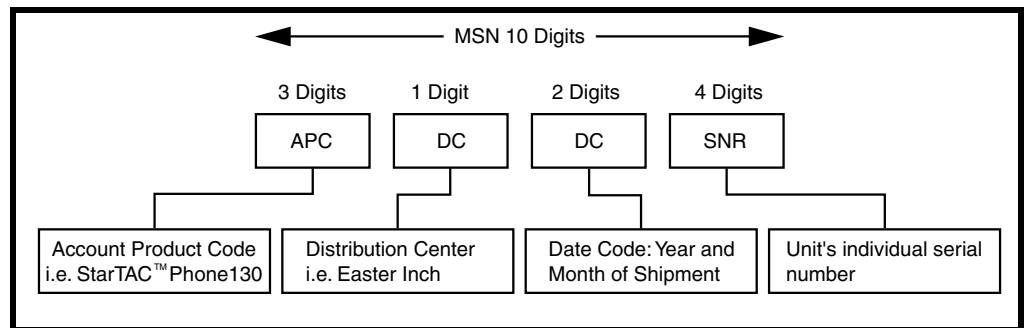

000807a

Figure 21. MSN label breakdown

---

### International Mobile Station Equipment Identity (IMEI)

The International Mobile station Equipment Identity (IMEI) number is an individual number unique to the PCB and is stored within the unit's memory.

The IMEI uniquely identifies an individual mobile station and thereby provides a means for controlling access to GSM networks based on mobile station types or individual units. The full IMEI structure is listed in Table 2.

**Table 2. IMEI Number Breakdown**

TAC	Serial Number	Check Digit
NNXXXXXX	ZZZZZZ	A

Where

**TAC** Type Allocation Code, formerly known as Type Approval Code

**NN** Reporting body identifier

**XXXX** Type Identifier

**ZZZZZZ** Individual unit serial number

**A** Phase 1 = 0.

Phase 2 = check digit defined as a function of all other IMEI digits

Other label number configurations present are:

- **TRANSCIVER NUMBER:** Identifies the product type. Normally the SWF number. (i.e. V100).
- **PACKAGE NUMBER:** Identifies the equipment type, mode, and language in which the product is shipped.

# Telephone Identification

## Identification Label

Each Motorola GSM phone is labeled with a variety of identifying numbers. Figure 16 describes the current identifying labels.

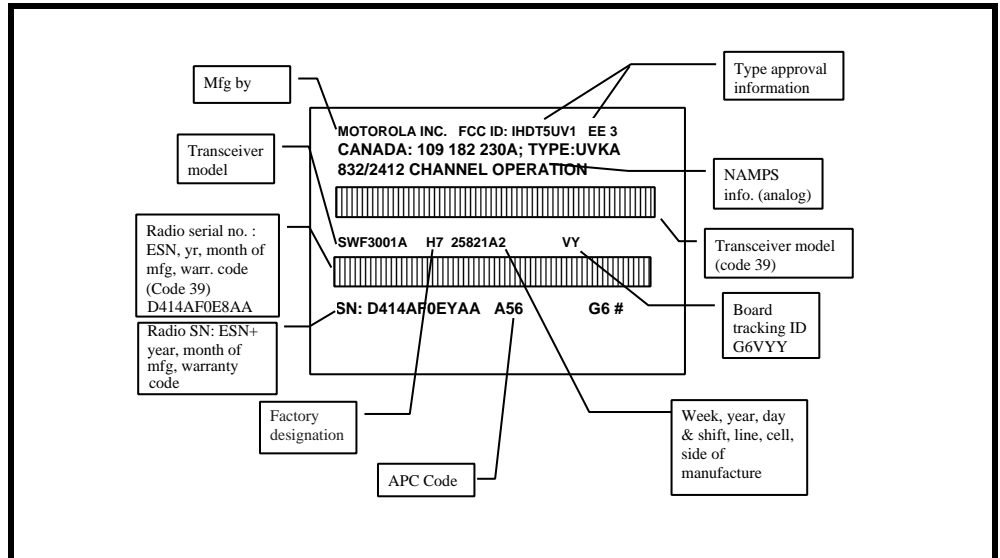

0204630



Figure 22. Telephone Identification Label

# Troubleshooting

## Manual Test Mode

MotoSLVR L7I/ L7E telephones are equipped with a manual test mode capability. This allows service personnel to verify functionality and perform fault isolation by entering keypad commands.

To enter the manual test command mode, a GSM / DCS test SIM must be used.

1. Press  to turn the phone OFF.
2. Remove the battery as described in the procedures.
3. Remove the customer's SIM card from the phone as described in the procedures.
4. Insert the test SIM into the SIM slot.
5. Replace the battery as described in the procedures.
6. Press  to turn the phone ON.

## Manual Test Mode Commands

**Table 3. Manual Test Commands**

Key Sequence	Test Function/Name	Remarks
<Menu>048263*	Enter manual test mode	
"End" Key	Exit manual test mode	
54*	Suspend	Required for all Test Mode Operations
0*0*0	Select tone 0	
0*0*1	Select tone 1	
0*0*2	Select tone 2	
0*0*3	Select tone 3	
0*0*4	Select tone 4	
0*0*5	Select tone 5	
0*0*6	Select tone 6	
0*0*7	Select tone 7	
0*0*8	Select tone 8	
0*0*9	Select tone 9	
0*1*X	Disable tone X	
3*0*1	Enable vibrator	
3*0*0	Disable vibrator	
5*0*0	Set audio level 0	
5*0*1	Set audio level 1	
5*0*2	Set audio level 2	
5*0*3	Set audio level 3	
5*0*4	Set audio level 4	
5*0*5	Set audio level 5	
5*0*6	Set audio level 6	
5*0*7	Set audio level 7	

**Table 3. Manual Test Commands (Continued)**

Key Sequence	Test Function/Name	Remarks
5*0*8	Set audio level 8	
5*0*9	Set audio level 9	
5*0*10	Set audio level 10	
5*0*11	Set audio level 11	
5*0*12	Set audio level 12	
5*0*13	Set audio level 13	
5*0*14	Set audio level 14	
5*0*15	Set audio level 15	
6*2*2*0*0	Set Audio Path. Int Mic, IntSpk, RX unmute, TX unmute	
6*4*6*0*0	Set Audio Path. Boom Mic, Boom Spk, RX unmute, TX unmute	
10*0*3	Set band GSM 900	
10*0*4	Set band DCS 1800	
10*0*5		
10*0*6	Set dual band GSM 900 / 1800	
10*1*0	Read band	3= GSM 4= DCS 5= PCS 6 =GSM/DCS
18*0	Initialize non-volatile memory (Master Reset)	
18*1	Initialize non-volatile memory (Master Clear)	
55*2*001	Test Display. All pixels ON	
55*2*000	Test Display. All pixels OFF	
55*2*002	Test Display. Checkerboard pattern A	
55*2*003	Test Display. Checkerboard pattern B	
55*2*004	Test Display. Border pixels ON	
*#06#	IMEI Check	No Test Mode Required
Phone Set up --> Phone Status --> Other Information	Flex Version / Technology / S-W Version / Readiness Status	No Test Mode Required



## Troubleshooting Chart

**Table 4. Level 1 and 2 Troubleshooting Chart**

Symptom	Probable Cause	Verification and Remedy
1. Telephone will not turn on or stay on.	a) Battery either discharged or defective.	Measure battery voltage across a 50 ohm (>1 Watt) load. If battery voltage is <3.25 Vdc, recharge the battery using the appropriate battery charger. If battery will not recharge, replace the battery. If battery is not at fault, proceed to b.
	b) Battery terminals open or misaligned.	Visually inspect battery terminals on both the battery and the telephone. Realign and, if necessary, either replace the battery or refer to a Level 3 Service Center for battery connector replacement. If battery terminals are not at fault, proceed to c.
	c) Transceiver board defective.	Remove the transceiver board assembly. Substitute a known good transceiver board and temporarily reassemble the phone. Press the Power/End key; if phone turns on and stays on, disconnect the dc power source and reassemble the phone with the new transceiver board. Verify that the fault has been cleared.
2. Telephone exhibits poor reception or erratic operation such as calls frequently dropping or weak or distorted audio.	a) Antenna defective.	Check connection between the antenna and the transceiver board. If the connection is OK, substitute a known good antenna. If the fault is still present, proceed to b.
	b) Transceiver board defective.	Replace the transceiver board (refer to 1c). Verify that the fault has been cleared and reassemble the phone with the new transceiver board.
3. Display is erratic.	a) Display module defective	Temporarily replace the display module with a known good display module. Verify that the fault is cleared and reassemble the phone with the new display module. If the fault is still present, proceed to b.
	b) Transceiver board defective.	Replace the transceiver board (refer to 1c). Verify that the fault has been cleared and reassemble the phone with the new transceiver board.
4. Incoming call alert transducer audio is distorted.	a) Alert transducer defective	Temporarily replace the alert transducer with a known good alert transducer. Verify that the fault is cleared and reassemble the phone with the new alert transducer. If the fault is still present, proceed to b.
	b) Faulty transceiver board.	Replace the transceiver board (refer to 1c). Verify that the fault has been cleared and reassemble the phone with the new alert transducer.
5. Telephone transmit audio is weak. (usually indicated by called parties complaining of difficulty in hearing voice).	a) Microphone defective.	Replace the microphone as described in the procedures. If fault is not cleared, proceed to b.
	b) Transceiver board defective.	Replace the transceiver board (refer to 1c). Verify that the fault has been cleared and reassemble the phone with the new transceiver board.
6. Receive audio from earpiece speaker is weak or distorted.	a) Connections to or from transceiver board defective.	Check connection from the earpiece to the transceiver board. If connection is not at fault, proceed to b.

**Table 4. Level 1 and 2 Troubleshooting Chart (Continued)**

Symptom	Probable Cause	Verification and Remedy
	b) Earpiece speaker defective.	Temporarily replace the speaker with a known good speaker. Ensure good connection. Place a call and verify improvement in earpiece audio. If fault is cleared, reassemble the phone with the good transceiver board. If fault is not cleared, proceed to c.
	c) Transceiver board defective.	Replace the transceiver board (refer to 1c). Verify that the fault has been cleared and reassemble the phone with the new transceiver board.
7. Vibrator feature not functioning.	a) Vibrator defective.	Replace vibrator. If the fault has not been cleared, proceed to b.
	b) Transceiver board defective.	Replace the transceiver board (refer to 1c). Verify that the fault has been cleared and reassemble the phone with the new transceiver board.
8. Internal Charger not working.	Faulty charger circuit on transceiver board.	Test a selection of batteries in the rear pocket of the desktop charger. Check LED display for the charging indications. If these are charging properly, then the internal charger is at fault. Replace the transceiver board assembly (refer to 1c). Verify that the fault has been cleared and reassemble the phone with the new transceiver board assembly.

---

## Part Numbers

The following section provides a reference for the parts associated with MotoSLVR L7i/ L7e telephones.

### Exploded View Diagram

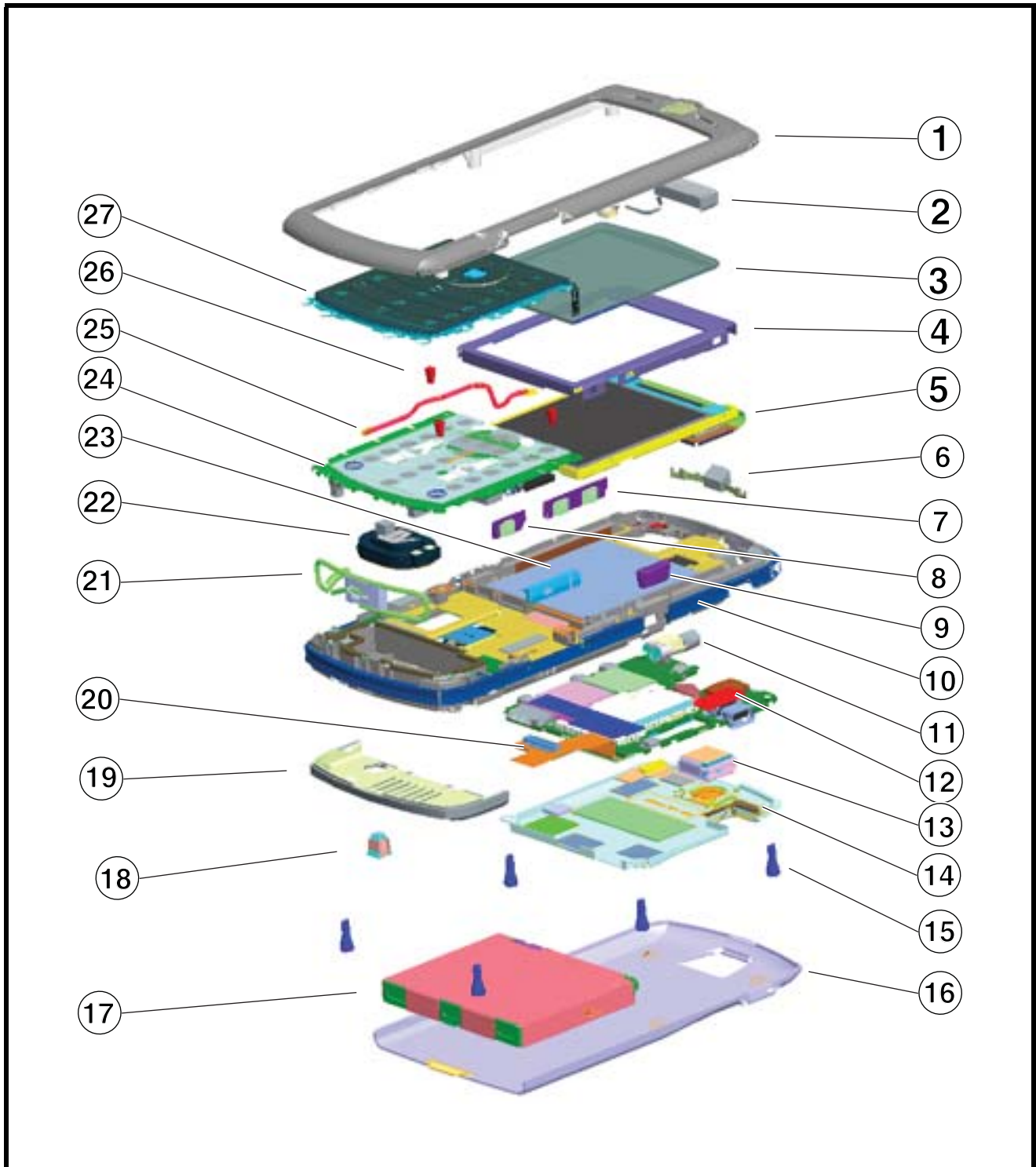

0616420

Figure 23. Exploded View Diagram

## Exploded View Parts List

Table 5. Parts list

Item	Motorola Part Number	Description
1	AAHN5853A	Assy Front Hsg
2	0170298Z53	Earpiece
3	6171080A05	Lens
4	1303631B10	LCD Bezel
5	7271333A01	Main Display
6	0171310A02	Assy, Battery Latch
7		
	3871077A02	Side Button, VOL
8	3871079A02	Side Button, Smart
9		
	3871099A02	Side Button, Camera
10	0170392C01	Assy Chassis
11	5989889N01	Vibrator
12	AALG4365AA	Assy, Main PCB
13	0171289A55	Camera Module 1.3MP

Item	Motorola Part Number	Description
14	0171737A01	Assy, PCB Cover
15	0387791L04	T6 Screws
16	AAHN5854A	Battery Door
17	SNN5784A	BK60 Battery Pack
18	0571083A06	RF Grommet
19	AAHN5861A	Rear Hsg
20		
	0170386F06	Assy, Flex Interconnection
21	0170298Z26	Antenna Assy
22		
	0170298Z13	Polyphonic Speaker Assy
23	0571084A01	T-Flash Cover
24	0170386F20	Assy, Keypad PCB
25	0371383A01	T5 Screws
26	3070338B02	Coaxial cable
27	AAYN4789A	Keypad



*There is a danger of explosion if the Lithium ion battery pack is replaced incorrectly. Replace only with the same type of battery or equivalent as recommended by the battery manufacturer. Dispose of used batteries according to the manufacturer's instructions.*

To order parts please use the following link:

<https://accesssecure.mot.com>

(Password is required)

---

## Accessories

**Table 6. List of Accessories**

Accessory Description	Kit Number
<b>Audio and Media</b>	
RAZR H3 Black	SYN1437
RAZR H3 Silver	SYN1438
Stereo Headset - EMU	SYN1301
H3 Bluetooth Headset Dark Pearl Grey	SYN1507
H500 Bluetooth headset Black Softtouch	SYN1374
H500 Bluetooth Headset Hot Pink	SYN1525
H500 Bluetooth Headset iPOD Blue	SYN1523
H500 Bluetooth Headset iPOD Gold	SYN1524
H500 Bluetooth Headset Spa Blue	SYN1527
H500 Bluetooth Headset White	SYN1526
H500 Gloss Black	SYN1375
H500 Nickel Japan	SYN1441
H500 Pink	SYN1436
Headset Mono One Touch w/ Send-End (EMU)	SYN0896
H350 BT Headset Black	SYN1439
JBL On Tour Mobile European Kit	OnTourMBBLKE
JBL On Tour Mobile portable speaker US Kit	OnTourMBBLK
JBL On Tour Mobile speaker PRC kit	CH1414A
JBL On Tour Mobile speaker UK kit	OnTourMBBLKU
S805 DJ Headset - Bluetooth - Music and Telephony	SYN1673
JBL Black On Tour Portable Speaker	SYN1451
H500 Bluetooth Headset Fire Red	SYN1667
H500 Bluetooth Headset Celery	SYN1732
H500 Bluetooth Headset Pumpkin	SYN1733
H500 Bluetooth Headset Steel Teal	SYN1734
H500 Bluetooth Headset Oi	SYN1735
H3 Bluetooth Headset Cherry Red	SYN1736
H350 Bluetooth Headset Sapphire Blue	SYN1738
H350 Bluetooth Headset Silver Sail	SYN1764
H350 Bluetooth Headset Dark Pearl Grey	SYN1763
H350 Bluetooth Headset Silver Quartz	SYN1765
H500 Bluetooth Headset Black Soft Touch Japan	SYN1685
H500 Bluetooth Headset Bubble Gum	SYN1671
H500 Bluetooth Headset Cosmic Blue	SYN1617
Bluetooth Stereo Headset & Controller S705	SYN1711
D&G Gold H700	SYN1769

**Table 6. List of Accessories (Continued)**

<b>Accessory Description</b>	<b>Kit Number</b>
Blue/Black Cingular Only H700	SYN1508
Black H700 (not available in North America)	SYN1509
Bluetooth Headset - HS805	SYN0986
H670 Black Slate (Canary)	SYN1853
H670 Cosmic Blue (Canary)	SYN1855
H670 Silver Quartz (Canary)	SYN1852
Bluetooth Headset - HS850 (Refresh - Black)	SYN1107
Bluetooth Headset - HS850 (Refresh - Blue)	SYN1226
Bluetooth Headset - H700 (silver)	SYN1311
Bluetooth Headset (Pearl Dark Gray) - H300	SYN1297
Bluetooth Headset (Pink) - H300	SYN1417
Bluetooth Headset (Pure White) - H300	SYN1416
Bluetooth Headset - H605	SYN1303
Bluetooth Mono Headset, Nickel- H500	SYN1290
Bluetooth Stereo Headset HT820	SYN0948
Bluetooth Stereo Transceiver DC800	SYN1001
<b>Automotive</b>	
Bluetooth Car Kit - HF850	98675H
Bluetooth Car Kit - IHF1000 - Americas/Asia	98676J
Bluetooth Car Kit - IHF1000 - EMEA	CFLN1232AB
Bluetooth Car Kit - High Tier, T505	SYN1717
Bluetooth Car Kit - Mid Tier, T305	SYN1716
<b>Data and Enterprise</b>	
1GB micro SD card & Mot SD adapter	SYN1406
128MB micro SD card & Mot SD adapter	SYN1403
256MB micro SD card & Mot SD adapter	SYN1404
32MB micro SD card & Mot SD adapter	SYN1401
512MB micro SD card & Mot SD adapter	SYN1405
64MB micro SD card & Mot SD adapter	SYN1402
Bluetooth Class 1 USB Adapter PC850	SYN1244
<b>Digital Accessories</b>	
Data Cable Mini USB/USB/Serial	SKN6371
Mobile Phone Tools	Region-specific
<b>Modules</b>	
Reverb (Oakley Stereo Bluetooth Eyewear - BLK)	SYN1552
Reverb (Oakley Stereo Bluetooth Eyewear - WHT)	SYN1553
REVERB (Oakley Stereo Bluetooth Eyewear Brown. Sm.)	SYN1554
Oakley RAZRWIRE (Mercury: NA) - H7	98679H

**Table 6. List of Accessories (Continued)**

<b>Accessory Description</b>	<b>Kit Number</b>
Oakley RAZRWIRE (Pewter/Black: NA) - H7	98677H
Oakley RAZRWIRE (Platinum/Root Beer: NA) - H7	98678H
<b>Power and Personalization</b>	
Battery BK60 Li-Ion 880 mAh	SNN5784
Charger Adapter EMU/EMU (Y-cable)	SKN6222
Standard Car Charger EMU - P310	syn1630
Travel Charger EMU Mid-Rate Switcher - Argentina	SPN5192
Travel Charger EMU Mid-Rate Switcher - Australia	SPN5193
Travel Charger EMU Mid-Rate Switcher - BRAZIL	SPN5187
Travel Charger EMU Mid-Rate Switcher - EURO	SPN5189
Travel Charger EMU Mid-Rate Switcher - INDIA	SPN5194
Travel Charger EMU Mid-Rate Switcher - MEXICO	SPN5186
Travel Charger EMU Mid-Rate Switcher - PRC	SPN5188
Travel Charger EMU Mid-Rate Switcher - TWN	SPN5216
Travel Charger EMU Mid-Rate Switcher - UK/HK	SPN5190
Travel Charger EMU Mid-Rate Switcher - US ENG	SPN5185
Travel Charger EMU Rapid Switcher - Argentina	SPN5197
Travel Charger EMU Rapid Switcher - BRAZIL	SPN5196
Travel Charger EMU Rapid Switcher - HK	SPN5199
Travel Charger EMU Rapid Switcher - MEXICO	SPN5200
Travel Charger EMU Rapid Switcher - PRC	SPN5198
Travel Charger EMU Rapid Switcher - US	SPN5202
Travel Charger EMU Rapid TWN	SPN5270
Vehicle Power Adapter EMU - VC700	SYN0847
Battery-Only-Charger for SC batteries, Hong Kong plug	SYN1486A
Battery-Only-Charger for SC batteries, PRC plug	SYN1492A
Battery-Only-Charger for SC batteries, Taiwan plug	SYN1485
Battery-Only-Charger for SC batteries, US/Euro plug	SYN1484
BATTERY-ONLY-CHARGER FOR KC/BK BATTERIES US PLG	SYN1699A
Battery-Only-Charger, KC (BK) battery, PRC plug	SYN1700
Travel Charger EMU Mid-Rate Switcher - JAPAN	SPN5274
Travel Charger EMU Rapid Switcher - Japan	SPN5275



## Related Publications

MotoSLVR L7i/e User's Guide (English)

68XXXXX163

## Programming: Software Upgrade and Flexing

Contact your local technical support engineer for information about equipment and procedures for flashing and flexing.



---

## Index

### A

antenna cap, removing and replacing 21  
antenna, removing and replacing 33

### B

battery  
    charge indicator 15  
    function 15  
Battery cover, removing and replacing 18  
battery, removing and replacing 18, 19

### C

camera assembly, removing and replacing 27  
Canadian Interference-Causing Equipment regulations 5  
commands, manual test mode 39  
copyrights  
    computer software 6

### D

disassembly 18  
display module, removing and replacing 34

### E

exploded view diagram 44  
exploded view parts list 45

### F

FCC rules 5  
Front Housing, removing and replacing 29

### I

identification  
    international mobile station equipment identity 37  
    mechanical serial number 36  
    product 5  
identification, labels 36, 38  
IMEI 37  
Introduction 5

### K

keypad PC board, removing and replacing 30, 31  
keypad, removing and replacing 30

### L

LCD 13  
liquid crystal display (LCD) 13

### M

manual test mode 39  
MSN 36

### N

names  
    product 5

### O

operation 13  
    battery 15  
    controls, indicators, and I/O connectors 13  
    icons 14  
    LCD 13  
overview, product 11

### P

parts  
    exploded view diagram 44  
    exploded view parts list 45  
Parts Replacement 7  
product  
    identification 5  
    names 5  
product overview 11  
    features 11  
publications, related 49

### R

regulatory agency compliance 5  
related publications 49  
Removing  
    keypad 30  
removing  
    antenna 33  
    antenna cap 21  
    battery 15, 18, 19  
    battery cover 18  
    camera assembly 27  
    display module 34  
    front housing 29  
    keypad PC board 30, 31  
    SIM 20  
    Transceiver PC Board 24

---

Transceiver PC Board Shield 22

replacing

- antenna 33
- antenna cap 21
- battery 18, 19
- battery cover 18
- camera assembly 27
- display module 34
- front housing 29
- keypad 30
- keypad PC board 30
- keypad PC board shield 31
- SIM 20
- Transceiver PC Board 24
- Transceiver PC Board Shield 22

warranty service 7

## S

serial number

- mechanical 36

service manual

- about 6
- audience 6
- conventions 7
- scope 6

service policy 7

- customer support 7
- out of box failure 7
- product support 7

shut down

- upon battery removal 15

SIM, description 36

SIM, removing and replacing 20

specifications 9

subscriber identity module (SIM) 36

support

- customer 7
- product 7

## T

test equipment 17

tools, disassembly 17

Transceiver PC Board Shield, removing and replacing 22

Transceiver PC Board, removing and replacing 24

troubleshooting 39

- manual test mode 39
- manual test mode commands 39
- troubleshooting chart 41

## W



**MOTOROLA**