



MOTOROLA

Level 1 and 2 Service Manual

6809495A42-O

E1

Digital Wireless Telephone



GSM 850/900/1800/1900 MHz GPRS

Contents

Introduction	5
Product Identification	5
Product Names	5
Regulatory Agency Compliance	5
Computer Program Copyrights	6
About this Service Manual	6
Warranty Service Policy	7
Parts Replacement	8
Specifications	9
Product Overview	11
Features	11
General Operation	14
Controls, Indicators, and Input/Output (I/O) Connectors	14
User Interface Menu Structure	16
Alert Settings	16
Battery Function	17
Operation	17
Tools and Test Equipment	19
Disassembly	20
Removing and Replacing the Battery Cover	20
Removing and Replacing the Battery	21
Removing and Replacing the SIM	22
Removing and Replacing the Rear Housing	23
Removing and Replacing the Transceiver PC Board	23
Removing and Replacing the Keyboard	25
Removing and Replacing the Microphone	26
Removing and Replacing the Speaker	27
Removing and Replacing the Keypad	28
Removing and Replacing the Volume Switch Dome	29
Removing and Replacing the Display	30
Removing and Replacing the MFT Chamber Assembly and Camera	31
Removing and Replacing the Camera From MFT Chamber Assembly	32
Subscriber Identity Module (SIM) and Identification Label	33
SIM	33
Identification	33
Telephone Identification	35
Identification Label	35
Troubleshooting	36
Manual Test Mode	36
Troubleshooting Chart	37
Part Numbers	39
Exploded View Diagram	39
Exploded View Parts List	40
Accessories	41
Related Publications	43
Programming: Software Upgrade and Flexing	43

Introduction

Motorola® Inc. maintains a worldwide organization that is dedicated to provide responsive, full-service customer support. Motorola products are serviced by an international network of company-operated product-care centers as well as authorized independent service firms.

Available on a contract basis, Motorola Inc. offers comprehensive maintenance and installation programs that enable customers to meet requirements for reliable, continuous communications.

To learn more about the wide range of Motorola service programs, contact your local Motorola products representative or the nearest Customer Service Manager.

Product Identification

Motorola products are identified by the model number on the housing. Use the entire model number when inquiring about the product. Numbers are also assigned to chassis and kits. Use these numbers when requesting information or ordering replacement parts.

Product Names

Product names included in E1 telephones are listed on the front cover. Product names are subject to change without notice. Some product names, as well as some frequency bands, are available only in certain markets.

Regulatory Agency Compliance

This device complies with Part 15 of the FCC Rules. Operation is subject to the following conditions:

- This device may not cause any harmful interference, and
- must accept interference received, including interference that may cause undesired operation.

This class B device also complies with all requirements of the Canadian Interference-Causing Equipment Regulations (ICES-003).

Cet appareil numérique de la classe B respecte toutes les exigences du Règlement sur le matériel brouilleur du Canada.

Computer Program Copyrights

The Motorola products described in this manual may include Motorola computer programs stored in semiconductor memories or other media that are copyrighted with all rights reserved worldwide to Motorola. Laws in the United States and other countries preserve for Motorola, Inc. certain exclusive rights to the copyrighted computer programs, including the exclusive right to copy, reproduce, modify, decompile, disassemble, and reverse-engineer the Motorola computer programs in any manner or form without Motorola's prior written consent. Furthermore, the purchase of Motorola products shall not be deemed to grant either directly or by implication, estoppel, or otherwise, any license or rights under the copyrights, patents, or patent applications of Motorola, except for a nonexclusive license to use the Motorola product and the Motorola computer programs with the Motorola product.

About this Service Manual

Using this service manual and the suggestions contained in it assures proper installation, operation, and maintenance of E1 telephones. Refer questions about this manual to the nearest Customer Service Manager.

Audience

This manual aids service personnel in testing and repairing E1 telephones. Service personnel should be familiar with electronic assembly, testing, and troubleshooting methods, and with the operation and use of associated test equipment.

Use of this manual assures proper installation, operation, and maintenance of Motorola products and equipment. It contains all service information required for the equipment described and is current as of the printing date.

Scope

The scope of this manual is to provide basic information relating to E1 telephones, and provide procedures and processes for repairing the phones at Level 1 and 2 service centers including:

- Unit swap out
- Repairing of mechanical faults
- Basic modular troubleshooting
- Testing and verification of phone functionality
- Initiate warranty claims and send faulty modules to Level 3 or 4 repair centers

Conventions

Special characters and typefaces, listed and described below, are used in this manual to emphasize certain types of information.



Note: Emphasizes additional information pertinent to the subject matter.



Caution: Emphasizes information about actions that may result in equipment damage.



Warning: Emphasizes information about actions that may result in personal injury.



Keys to be pressed are represented graphically. For example, instead of “Press the Menu Key”, you will see “Press 

Information from a screen is shown in text as similar as possible to what appears in the display. For example, **ALERTS** or **ALERTS**.

Information that you need to type is printed in **boldface type**

Warranty Service Policy

This product is sold with the standard 12-month warranty terms and conditions. Accidental damage, misuse, and extended warranties offered by retailers are not supported under warranty. Non-warranty repairs are available at agreed fixed repair prices.

Out of Box Failure Policy

The standard out of box failure criteria applies. Customer phones that fail very early on after the date of sale, are to be returned to Manufacturing for root-cause analysis, to guard against epidemic criteria. Manufacturing will bear the costs of early life failure.

Product Support

Customer's original phone will be repaired but not refurbished as standard. Appointed Motorola Service Hubs will perform warranty and non-warranty field service for level 2 (assemblies) and level 3 (limited PCB component). The Motorola High Technology Centers will perform level 4 (full component) repairs.

Customer Support

Customer support is available through dedicated Call Centers and in-country help desks. Product Service training should be arranged through the local Motorola Support Center.

Parts Replacement

When ordering replacement parts or equipment, include the Motorola part number and description used in the service manual.

When the Motorola part number of a component is not known, use the product model number or other related major assembly along with a description of the related major assembly and of the component in question.

In the U.S.A., to contact Motorola, Inc. on your TTY, call: 800-793-7834.

Accessories and Aftermarket Division (AAD)

Order replacement parts, test equipment, and manuals from AAD.

U.S.A.

Phone: 800-422-4210

FAX: 800-622-6210

Website: <http://businessonline.motorola.com>

Outside U.S.A.

Phone: 847-538-8023

FAX: 847-576-3023

EMEA

Phone: +49 461 803 1638

Website: <http://emeaonline.motorola.com>

Asia

Phone: +65 648 62995

Website: <http://asiaonline.motorola.com>

Specifications

General Function	Specification
Frequency Range GSM 850	824-848 MHz Tx 869-893 MHz Rx
Frequency Range GSM 900	880-915 MHz Tx (with EGSM) 925-960 MHz Rx
Frequency Range DCS 1800	1710-1785 MHz Tx 1805-1880 MHz Rx
Frequency Range PCS 1900	1850-1910 MHz Tx 1930-1990 MHz Rx
Channel Spacing	200 kHz
Channels	174 EGSM, 374 DCS, 374 PCS, 124 GSM 850 carriers with 8 channels per carrier
Modulation	GMSK at BT = 0.3
Transmitter Phase Accuracy	5 Degrees RMS, 20 Degrees peak
Duplex Spacing	45 MHz
Frequency Stability	± 0.10 ppm of the downlink frequency (Rx)
Operating Voltage	+3.2V dc to +5.5V dc (battery) +4.8V dc to +6.5V dc (external connector)
Transmit Current Drain	101-260 mA average talk current drain
Stand-by Current drain	5 mA (DRX2), 2 mA (DXR9) typical
Temperature Range	-10° C to +55° C (+15° F to +130° F)
Dimensions, with 810 mAh Li Ion battery	108mm x 46mm x 20.5mm (4.25 inches x 1.8 inches x 0.80 inches)
Size (Volume)	89 cc (5.43 in ³), with battery
Weight	107 grams (3.77 oz), with battery
Battery Life, with standard 840 mAh Li-Ion Battery	Talk time 260-560 minutes Standby time 160 - 230 hours MP3 Playback time 275 minutes All talk and standby times are approximate and depend on network configuration, signal strength, and features selected. Standby times are quoted as a range from DRX=2 to DRX=9. Talk times are quoted as a range from DTX off to DTX on.
Battery Charge Time	4 hours to 90% of 840 mAh capacity
Alert volume	Max 95 dB @5cm, 0.5 Watts input

Transmitter Function	Specification
RF Power Output	32 dBm nominal GSM 850/900 29 dBm nominal GSM 1800/1900
Output Impedance	50 ohms nominal
Spurious Emissions	-36 dBm from 0.1 to 1 GHz, -30 dBm from 1 to 4 GHz

Receiver Function	Specification
Receive Sensitivity	Better than -103 dBm
RX Bit Error Rate (100k bits) Type II	< 2%

Speech Coding Function	Specification
Speech Coding Type	Regular pulse excitation/linear predictive coding with long term prediction (RPE LPC with LTP)
Bit Rate	13.0 kbps

Speech Coding Function	Specification
Frame Duration	20 ms
Block Length	260 bits
Classes	Class 1 bits = 182 bits; Class 2 bits = 78 bits
Bit Rate with FEC Encoding	22.8 kbps

Product Overview

Motorola E1 mobile telephones feature Global System for Mobile communication (GSM) technology. The mobile telephone uses a simplified icon and Graphical User Interface (GUI) for easier operation, allow Short Message Service (SMS) text messaging, and include clock, alarm, datebook, and calculator personal management tools. The E1 telephone features VibraCall vibrating alert and a selection of ring tones. The E1 is a quad-band phone that allows roaming within the GSM 850 MHz, GSM 900 MHz, 1800 MHz digital cellular system (DCS), and 1900 MHz PCS bands.

E1 telephones support GPRS and SMS in addition to traditional circuit switched transport technologies.

The telephones are made of polycarbonate plastic with a metal enclosure. The display, camera, speaker, the 19-key keypad, transceiver Printed-circuit Board (PCB), microphone, charger, headphone connectors, and power button are contained within the candy bar form-factor housing. The 840 mAh Lithium Ion (Li-Ion) battery provides up to 560 minutes of talk time with up to 230 hours of standby time¹. These telephones feature a 176 x 220 pixel display.

Features

The E1 phone comes with the iTunes application software for MP3 playback. iTunes allows transfer of up to 100 songs and PC sync with iTunes desktop.

E1 telephones use advanced, self-contained, sealed, custom integrated circuits to perform the complex functions required for GSM communication. Aside from the space and weight advantage, microcircuits enhance basic reliability, simplify maintenance, and provide a variety of operational functions.

Features available in the E1 telephone include:

- Quad-Band
- iTunes MP3 playback
- PC sync with iTunes desktop
- 22 KHz enhanced polyphonic speakers w/ vibration, MP3 and MIDI ringers, and full MP3 music listening with CD Quality Sound
- 3D Stereo Sound
- Bluetooth
- Rhythm Lights
- Enhanced Games w/ Vibration
- Video playback and Video Capture
- Removable Mini SD card Memory (up to 128 MB)
- Large, active color display (176 x 220, 262K TFT)
- Multi-Media Messaging (MMS)
- Integrated digital Camera (VGA quality) w/ camera light
- PIM functionality with Picture Caller ID
- Calling Line Identification

Upon receipt of a call, the calling party's phone number is compared to the phonebook. If the number matches a phonebook entry, that name displays. If there

1. All talk and standby times are approximate and depend on network configuration, signal strength, and features selected. Standby times are quoted as a range from DRX=2 to DRX=9. Talk times are quoted as a range from DTX off to DTX on.

is no phonebook entry, the incoming phone number displays. If no caller identification information is available, an incoming call message displays.



User must subscribe to a caller line identification service through their service provider.

Personal Information Management

The E1 telephone contains a built-in datebook with alarm reminders, message center, and a phonebook.

Other Features

Detailed descriptions of other features available for the E1 wireless telephone are in the appropriate E1 GSM User's Guide listed in the Related Publications section toward the end of this manual.

General Operation

Controls, Indicators, and Input/Output (I/O) Connectors

The E1 telephones' controls are on the front and rear of the device and on the keyboard as shown in Figure 1. Indicator icons are displayed on the LCD (see Figure 2).

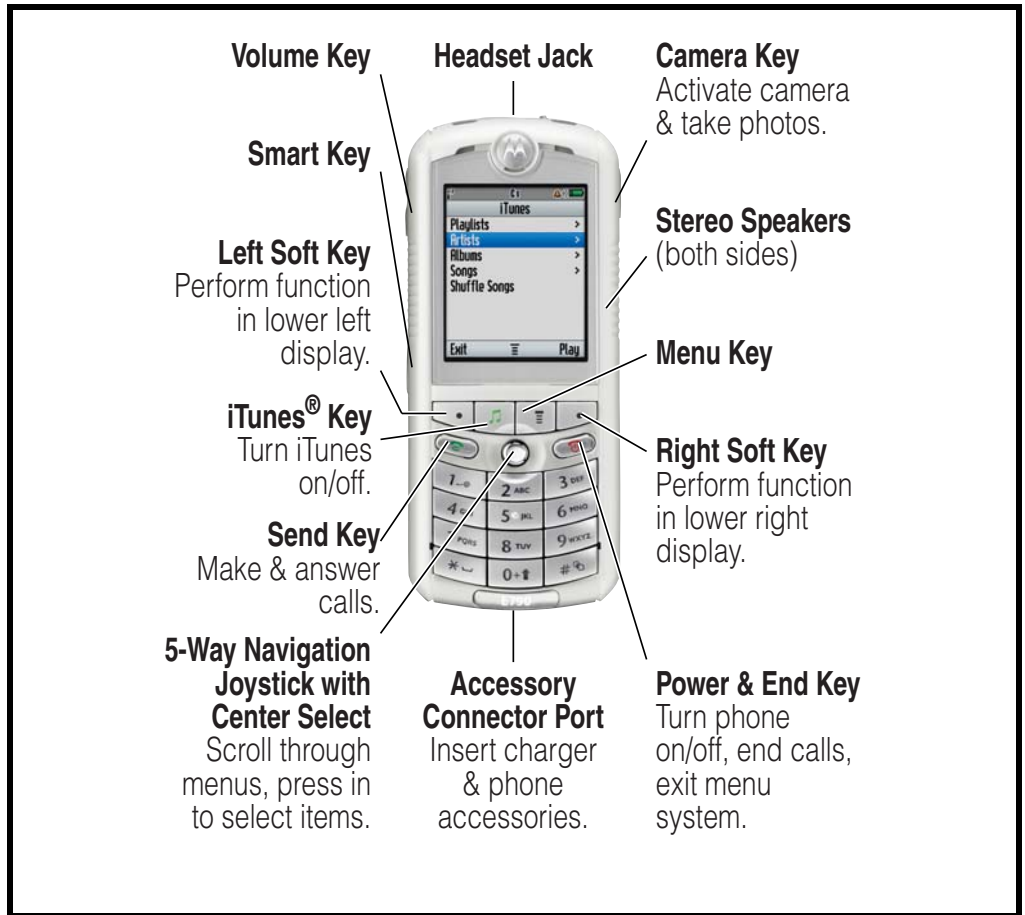

Figure 1. Controls and Indicators, Front



Figure 2. Controls and Indicators, Rear

Menu Navigation

E1 telephones have a simplified icon and GUI. See Figure 4 for the E1 menu structure. A scroll key allows you to move easily through menus.

Liquid Crystal Display (LCD)

The E1 phone features a 176 x 220 color display offering 3 lines of text, 1 line of icons, and 1 line of prompts. The display provides constant graphical representations of battery capacity and signal strength, as well as the real-time clock.

Display animation makes the phone's icon menu move smoothly as you scroll up and down.



Whether a phone displays all indicators depends on the programming and services to which the user subscribes.

Figure 2 shows common icons displayed on the LCD.

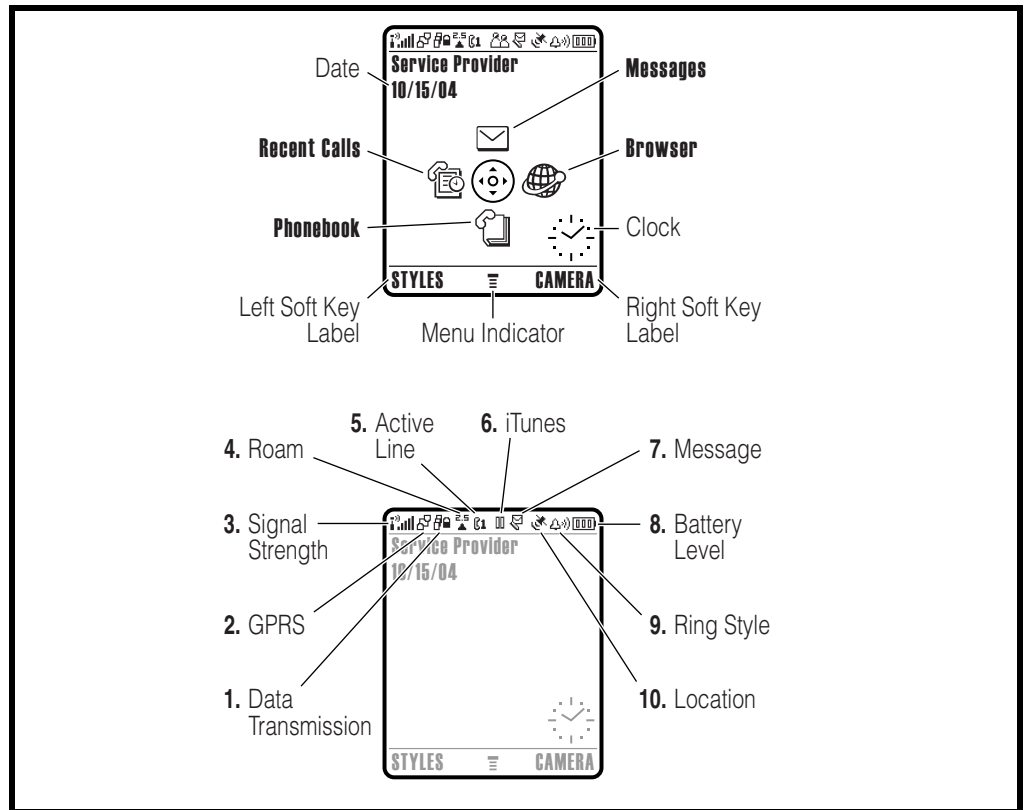

Figure 3. Display Idle Screen

- **Status Icons** show the status of your phone.
- **Real-Time Clock** shows the current time.
- Date shows the current date.
- **Soft Key Labels** provide selectable options in screen display.

User Interface Menu Structure

Figure 4 shows the E1 telephone menu structure.

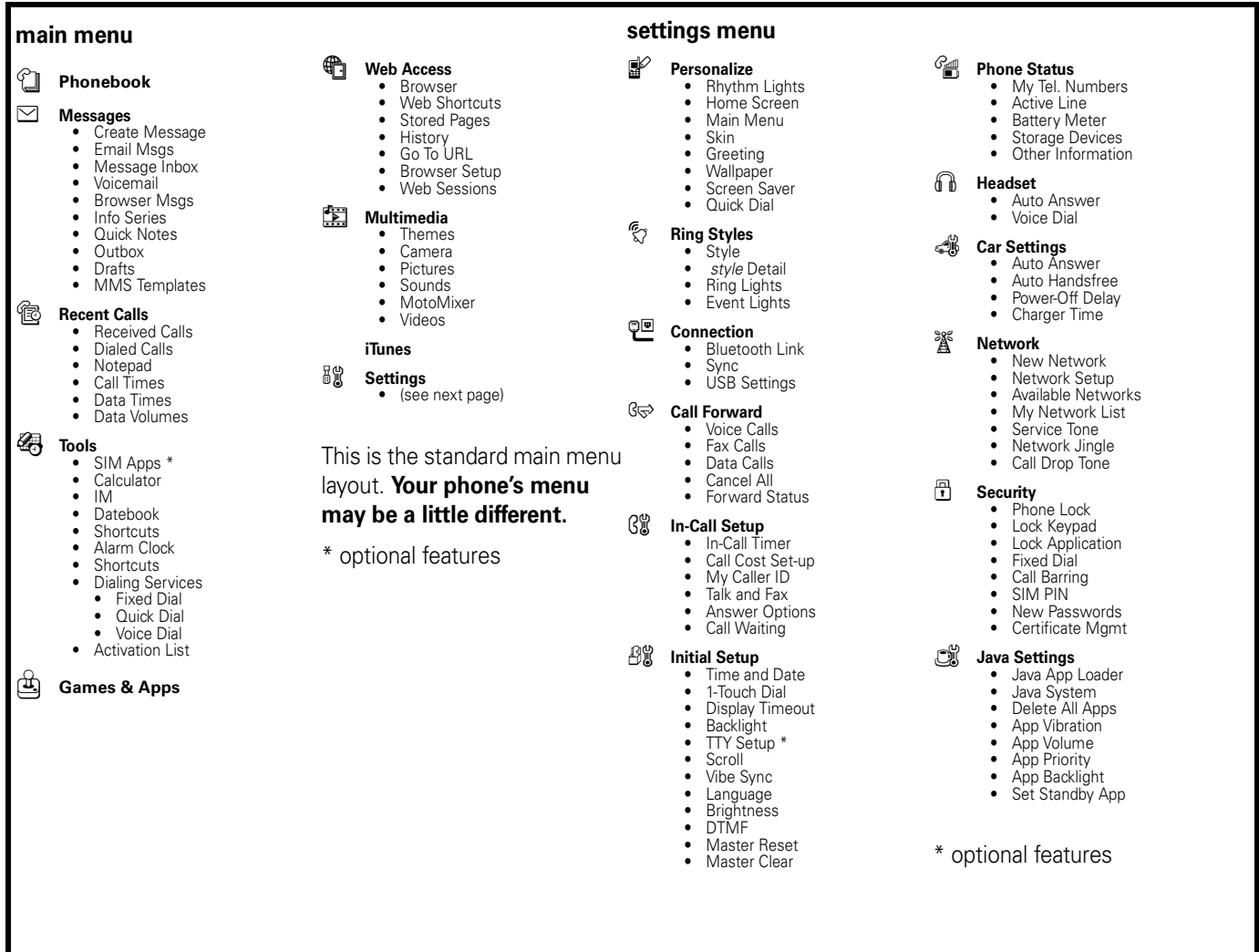

Figure 4. Menu Structure

Alert Settings

Motorola E1 phones incorporate the VibraCall[®] discreet vibrating alert that helps to avoid disturbing others when a ringing phone is unacceptable.

Alerts can be set to ring only, vibrate only, vibrate then ring, or no ring or vibrate.

Battery Function

Battery Charge Indicator

The telephone displays a battery charge indicator icon in the idle screen to indicate the battery charge level. The gauge shows 4 levels: 100%, 66%, 33%, and Low Battery.

Battery Removal

Removing the battery causes the phone to shut down immediately and lose any pending work. For example, (partially entered phonebook entries or outgoing messages).



All batteries can cause property damage and / or bodily injury such as burns if a conductive material such as jewelry, keys, or beaded chains touch exposed terminals. The conductive material may complete an electrical circuit (short circuit) and become quite hot. Exercise care when handling any charged battery, particularly when placing it inside a pocket, purse, or other container with metal objects.



If the battery is removed while receiving a message, the message is lost.



To ensure proper memory retention, turn the phone OFF before removing the battery. Immediately replace the old battery with a fresh battery.

Operation

For detailed operating instructions, refer to the appropriate User's Guide listed in the Related Publications section toward the end of this manual.

Tools and Test Equipment

Table 1 lists the tools and test equipment used on E1 telephones. Use either the listed items or equivalents.

Table 1. General Test Equipment and Tools

Motorola Part Number ¹	Description	Application
See Table 6.	Charger	Used to charge battery and power phone.
0180386A82	Antistatic Mat Kit (includes 66-80387A95 antistatic mat, 66-80334B36 ground cord, and 42-80385A59 wrist band)	Provides protection from damage to phone caused by electrostatic discharge (ESD).
6680388B67	Disassembly Tool, plastic with flat and pointed ends (manual opening tool)	Used during assembly/disassembly.
6680388B01	Tweezers, plastic	Used during assembly/disassembly.
RSX4043-A	Torque Driver	Used to remove and replace screws.
—	Torque Driver Bit T-6 Plus, Apex 440-6IP Torx Plus or equivalent	Used with torque driver.
HP34401A ²	Digital Multimeter	Used to measure battery voltage.

1. To order in North America, contact Motorola Aftermarket and Accessories Division (AAD) by phone at (800) 422-4210 or FAX (800) 622-6210; Internationally, you can reach AAD by phone at (847) 538-8023 FAX (847) 576-3023.

2. Not available from Motorola. To order, contact Hewlett Packard at (800) 452-4844.

Disassembly

This section describes how to disassemble a E1 telephone. Tools and equipment used are listed in Table 1.



Many of the integrated devices used in this phone are vulnerable to damage from ESD. Ensure adequate static protection is in place when handling, shipping, and servicing any internal components.



Avoid stressing the plastic in any way to avoid damage to either the plastic or internal components.

Removing and Replacing the Battery Cover

1. Ensure the phone is turned off.
2. Press down on the battery cover latch on the bottom of the phone, and gently slide the battery cover back away from the phone and lift it off (see Figure 5).

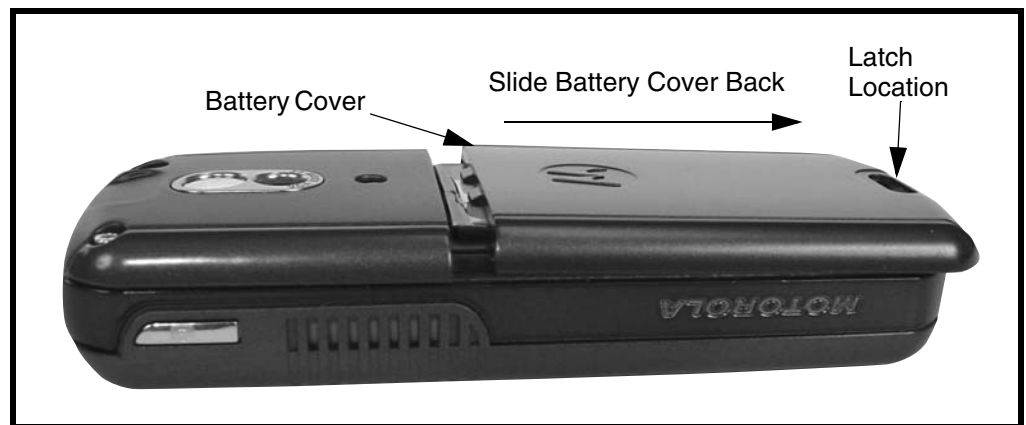

0410980

Figure 5. Removing the Battery Cover

3. To replace, align the battery cover with the rear housing.
4. Place the battery cover on the rear housing and gently slide the battery cover up into position it snaps into place.

Removing and Replacing the Battery

1. Remove the battery cover as described in the procedures.
2. Lift the top end of the battery as indicated by the arrow in Figure 6.
3. Lift the battery up and out of the battery compartment.



0410990

Figure 6. Removing and Replacing the Battery



There is a danger of explosion if the Lithium-Ion battery is replaced incorrectly. Replace only with the same type of battery or equivalent as recommended by the battery manufacturer. Dispose of used batteries according to the manufacturer's instructions.

4. To replace, insert the bottom of the battery into the battery compartment with contacts facing downward.
5. Press the top of the battery into the battery compartment.
6. Replace the battery cover as described in the procedures.

Removing and Replacing the SIM

1. Remove the battery cover and battery as described in the procedures.
2. Unlock the SIM holder by sliding it to the side of the phone.
3. Lift up the SIM holder and slide the SIM out (see Figure 7).

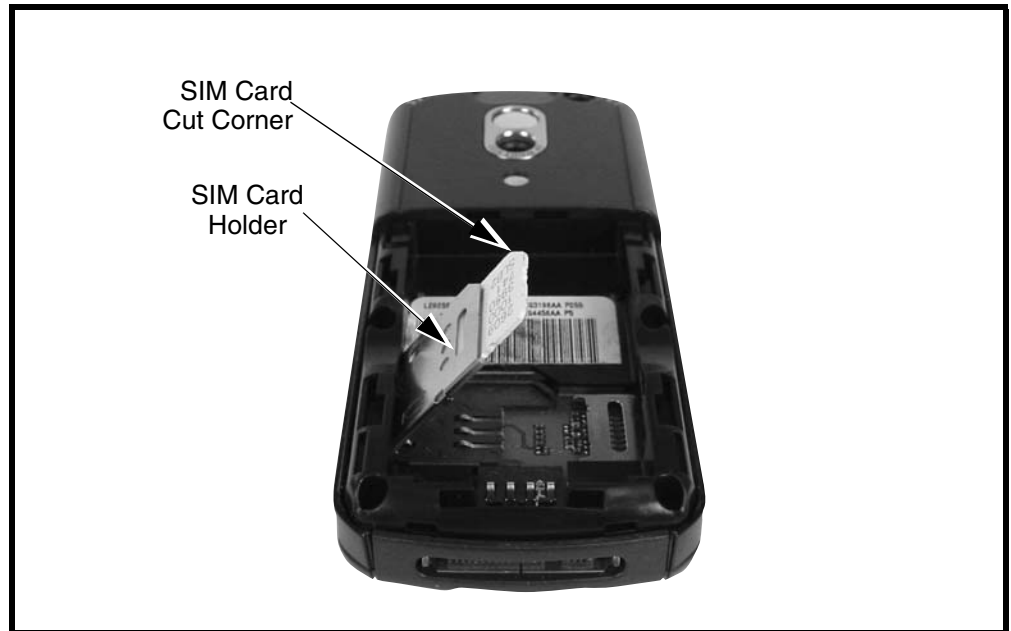

0411000

Figure 7. Removing and Replacing the SIM

4. To replace, slide the SIM into the SIM holder with the notched corner located as shown and press the SIM holder back down into the battery compartment.
5. Lock the SIM holder by sliding it toward the center of the battery compartment.
6. Replace the battery and battery cover as described in the procedures.

Removing and Replacing the Rear Housing

1. Remove the battery cover, battery, as described in the procedures.
2. Using a small screwdriver, gently pry off the left and right rubber screw covers that conceal the top two screws on the rear housing.
3. Using a Torx® driver with a T-6 bit, remove the 6 screws from the rear housing (see Figure 8).
4. Carefully separate the rear housing from the front housing by starting at the top and lifting the rear housing up and away from the front housing to remove.

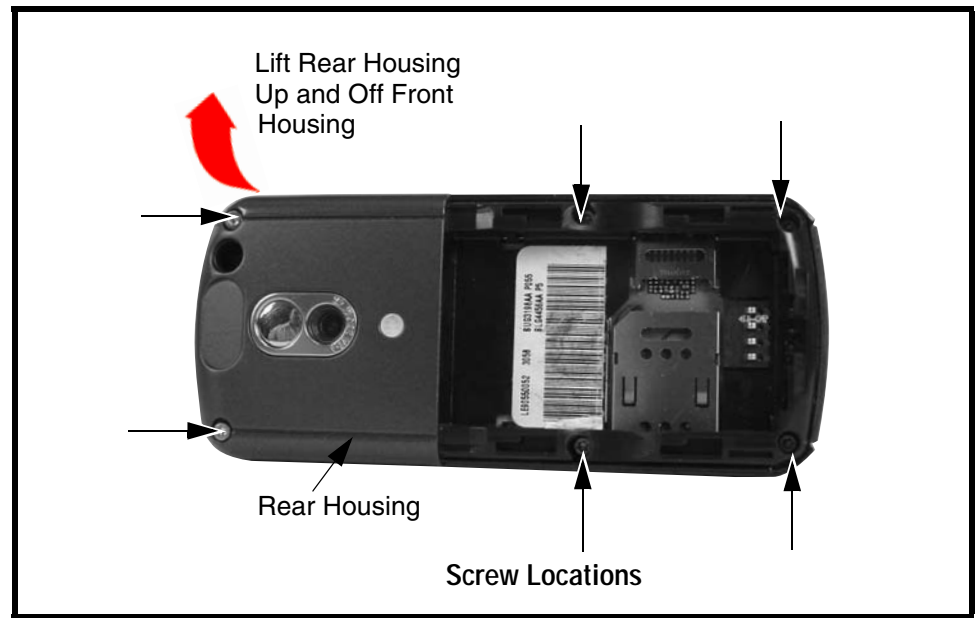

041101o

Figure 8. Removing and Replacing the Rear Housing

5. To replace, insert the bottom of the rear housing into the front housing and gently press together.
6. Insert and torque the 6 screws to 29 Ncm (2.6 in. pounds).
7. Replace the screw covers and rotate to match the curve of the rear housing and press firmly into place.
8. Replace the SIM, battery, and battery cover as described in the procedures.

Removing and Replacing the Transceiver PC Board

1. Remove the battery cover, battery, SIM, and rear housing as described in the procedures.



This product contains static-sensitive devices. Use anti-static handling procedures to prevent ESD and component damage.

2. Insert the flat end of the disassembly tool between the front housing and the transceiver PC board as shown in Figure 9.

3. At the top of the front housing, gently pry up and lift the transceiver PC board out of the front housing.

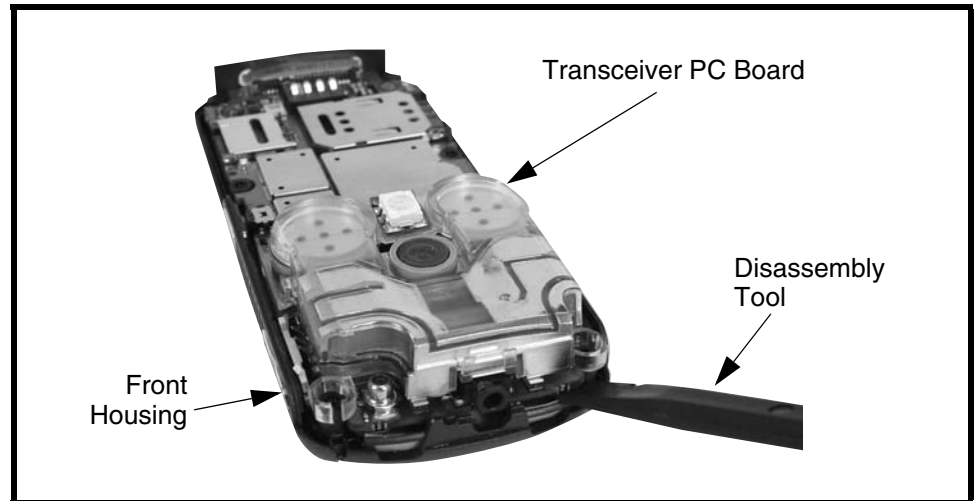

Figure 9. Removing and Replacing the Transceiver PC Board

4. To replace, insert the bottom of the circuit board into the bottom of the front housing (display side down) and gently press the top of the circuit board into the front housing.
5. Replace the rear housing, SIM, battery, and battery cover as described in the procedures.

Removing and Replacing the Keyboard

1. Remove the battery cover, battery, SIM, rear housing, and transceiver PC board, as described in the procedures.
2. Using the disassembly tool, gently pry up the keyboard disconnecting it from the transceiver PC board as shown in Figure 10.

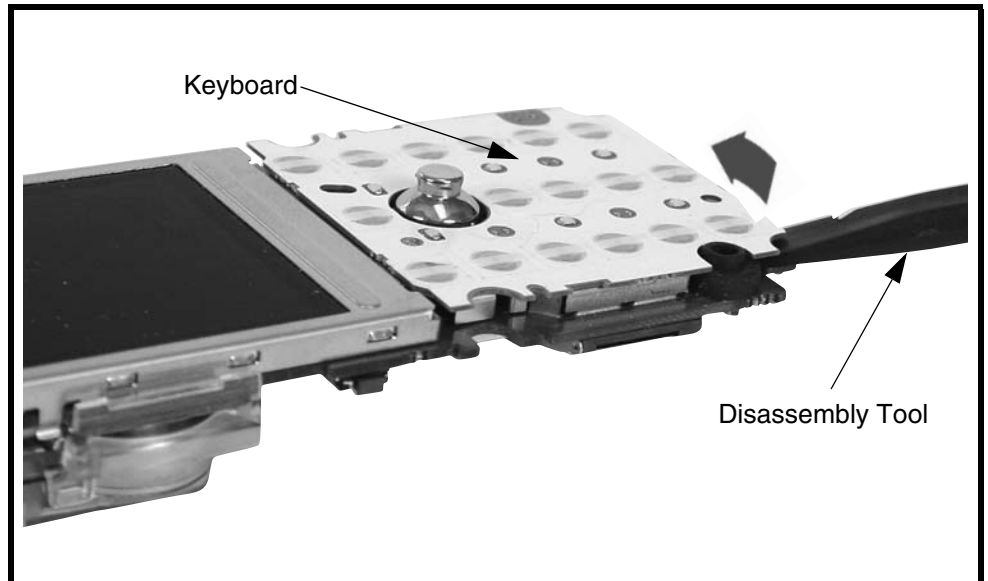

Figure 10. Removing and Replacing the Keyboard

041103o

3. To replace, align the keyboard connector of the keyboard with the keyboard connector on the transceiver board and press it into place.
4. Replace the transceiver PC board, rear housing, battery, and battery cover as described in the procedures.

Removing and Replacing the Microphone

1. Remove the battery cover, battery, SIM, rear housing, and transceiver PC board, and keyboard assembly as described in the procedures.
2. Use plastic tweezers remove the microphone grommet.
3. Use the disassembly tool or plastic tweezers unplug the microphone from the transceiver board as shown in Figure 11. Avoid damage to the microphone pins.

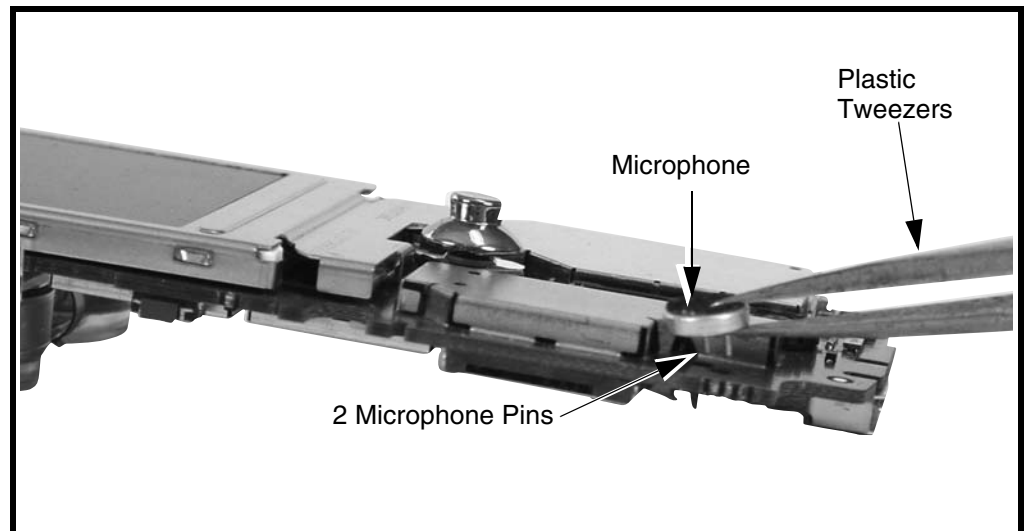

041104o

Figure 11. Removing and Replacing the Microphone

4. To replace, align the 2 microphone pins into the microphone contact holes. Press the microphone firmly in place.
5. Replace the microphone grommet over the microphone.
6. Replace the transceiver PC board in the front housing, replace the rear housing, SIM, battery, and battery cover as described in the procedures.

Removing and Replacing the Speaker

1. Remove the battery cover, battery, SIM, rear housing, and transceiver printed circuit (PC) board as described in the procedures.
2. Use the disassembly tool or plastic tweezers to release the speaker from the front housing as shown in Figure 12. The speaker should come away easily.

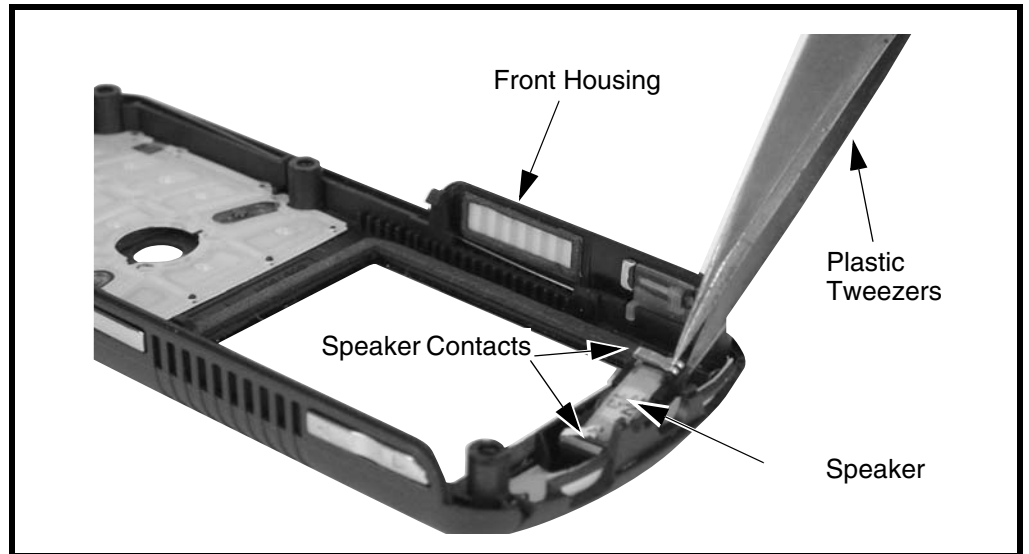

Figure 12. Removing and Replacing the Speaker

041105o

3. To replace, align the speaker with its socket with gold contacts facing as shown.
4. Gently press the speaker into place.
5. Replace the transceiver PC board, rear housing, battery, and battery cover as described in the procedures.

Removing and Replacing the Keypad

1. Remove the battery cover, battery, SIM, rear housing, and transceiver PC board, as described in the procedures.
2. Lift the keypad up from one corner as shown in Figure 13 and remove it from the front housing.

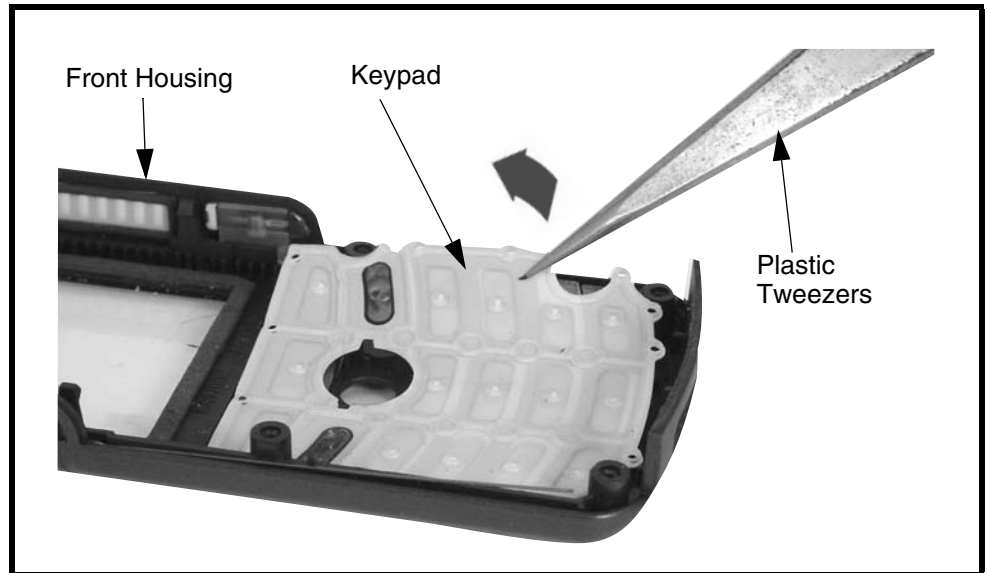

Figure 13. Removing and Replacing the Keypad

3. To replace, align the keypad with the front housing and press it into place.
4. Replace the transceiver PC board, rear housing, SIM, battery, and battery cover as described in the procedures.

Removing and Replacing the Volume Switch Dome

1. Remove the battery cover, battery, SIM, rear housing, and transceiver PC board, as described in the procedures.
2. Lift the volume switch dome out of the front housing as shown in Figure 14.

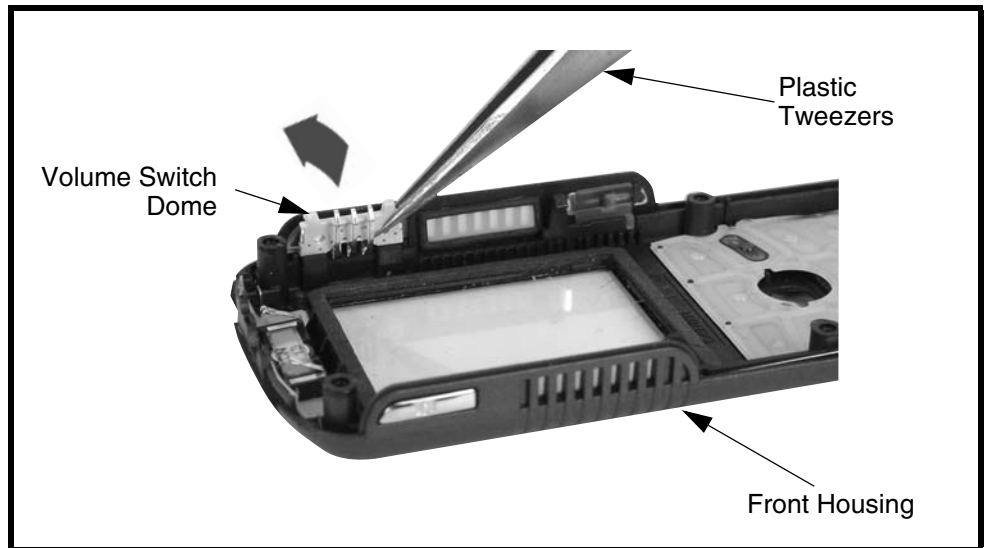
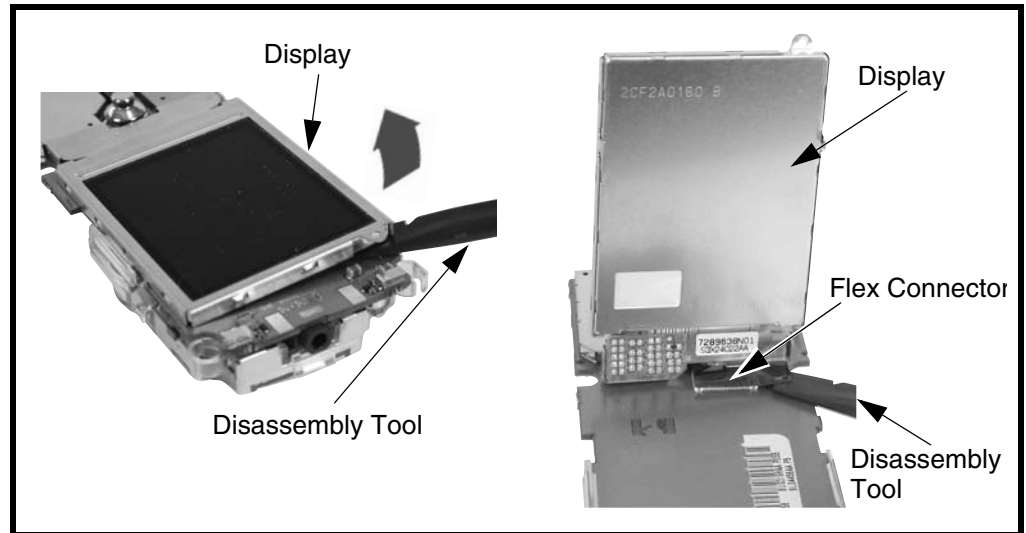

Figure 14. Removing and Replacing the Volume Switch Dome

3. To replace, insert the volume switch dome into its location in the front housing.
4. Replace the transceiver PC board, rear housing, SIM, battery, and battery cover as described in the procedures.

Removing and Replacing the Display

1. Remove the battery cover, battery, rear housing, and transceiver PC board as described in the procedures.
2. Using the disassembly tool, gently pry up the display from the transceiver PC board as shown in Figure 15.
3. Using the disassembly tool, gently unseat the display flex connector from its socket on the transceiver PC board.



041108o

Figure 15. Removing and Replacing the Display

4. To replace, place the display flex connector on the transceiver PC board display connector and press it into place.
5. Place the display on the transceiver PC board and gently press it into place.
6. Replace the transceiver PC board, rear housing, SIM, battery, and battery cover as described in the procedures.

Removing and Replacing the MFT Chamber Assembly and Camera

1. Remove the battery cover, battery, rear housing, and transceiver PC board as described in the procedures.
2. Disengage the two plastic MFT Chamber assembly side connectors from the transceiver PC board and lift off the MFT Chamber assembly as shown in Figure 16.
3. Using the disassembly tool, gently pry up the camera flex connector from the transceiver PC board.

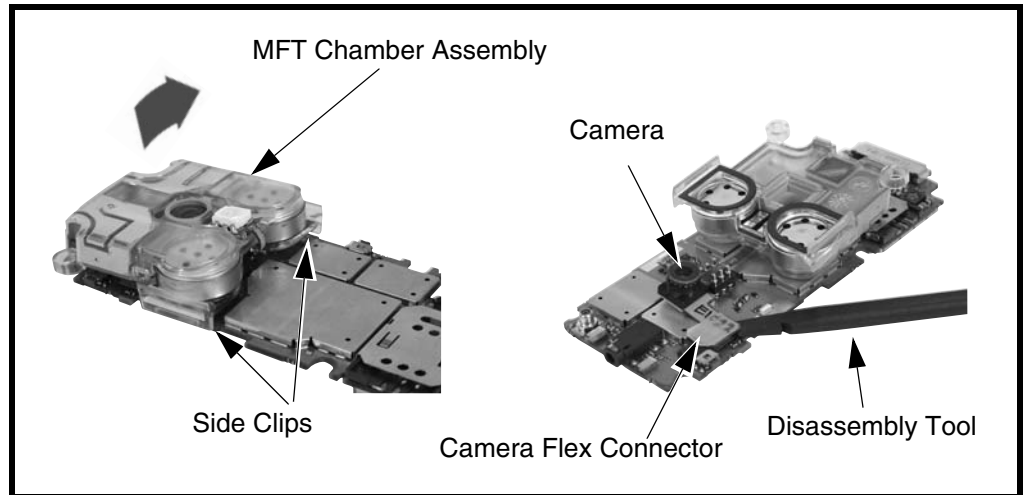

0411090

Figure 16. Removing and Replacing the MFT Chamber Assembly

4. To replace, place the camera flex connector on the transceiver PC board camera connector and press it into place.
5. Fold over the MFT Chamber assembly, aligning the camera with the camera hole in the MFT Chamber and press into place engaging the two plastic side connectors on to the transceiver PC board.
6. Replace the transceiver PC board, rear housing, SIM, battery, and battery cover as described in the procedures.

Removing and Replacing the Camera From MFT Chamber Assembly

1. Remove the battery cover, battery, rear housing, and transceiver PC board as described in the procedures.
2. Disengage the two plastic MFT Chamber assembly side connectors from the transceiver PC board and lift of the MFT Chamber assembly as shown in Figure 17.
3. Using the disassembly tool, gently pry up the camera flex connector from the transceiver PC board.
4. Using the disassembly tool, gently pry the connection between the camera flex and the MFT Chamber assembly separating the adhesive.

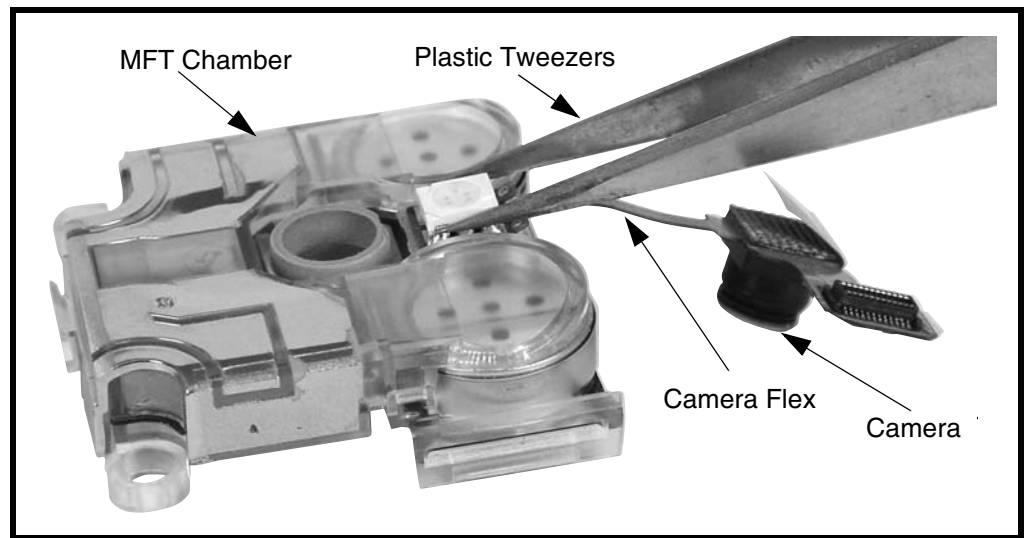

Figure 17. Removing and Replacing the Camera From the MFT Chamber Assembly

5. To replace, press the MFT Chamber side of the camera flex connector onto the MFT Chamber assembly.
6. Place the camera flex connector on the transceiver PC board camera connector and press it into place.
7. Fold over the MFT Chamber assembly, aligning the camera with the camera hole in the MFT Chamber and press into place engaging the two plastic side connectors on to the transceiver PC board.
8. Replace the transceiver PC board, rear housing, SIM, battery, and battery cover as described in the procedures.

Subscriber Identity Module (SIM) and Identification Label

SIM

A SIM is required to access the existing local GSM network, or remote networks when traveling (if a roaming agreement has been made with the provider).

The SIM card contains:

- All the data necessary to access GSM services
- The ability to store user information such as phone numbers
- All information required by the network provider to provide access to the network

Identification

Each Motorola GSM phone is labeled with a variety of identifying numbers. The following information describes the current identifying labels.

Mechanical Serial Number (MSN)

The MSN is an individual unit identity number and remains with the unit throughout its life.

The MSN can be used to log and track a phone on Motorola's Service Center Database.

The MSN is divided into 4 sections as shown in Figure 18.

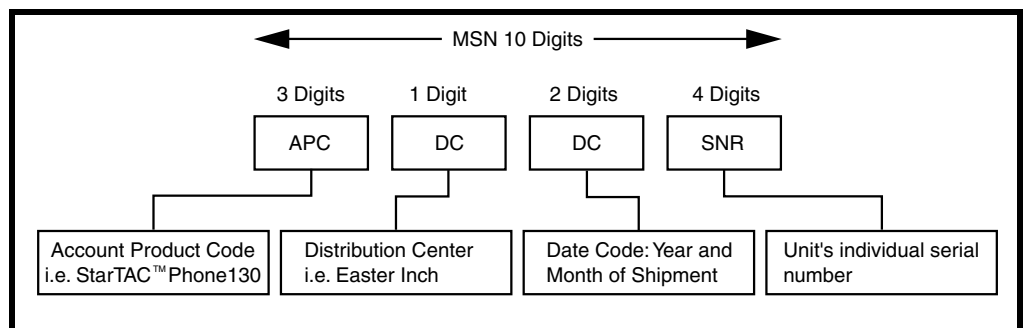

Figure 18. MSN label breakdown

000807a

International Mobile Station Equipment Identity (IMEI)

The International Mobile station Equipment Identity (IMEI) number is an individual number unique to the PCB and is stored within the unit's memory.

The IMEI uniquely identifies an individual mobile station and thereby provides a means for controlling access to GSM networks based on mobile station types or individual units. The full IMEI structure is listed in Table 2.

Table 2. IMEI Number Breakdown

TAC	Serial Number	Check Digit
NNXXXX YY	ZZZZZZ	A

Where

TAC Type Allocation Code, formerly known as Type Approval Code

NN Reporting body identifier

XXXX Type Identifier

YY YY is set to 00 from 01/01/2003 until 31/03/2004

ZZZZZZ Individual unit serial number

A Phase 1 = 0.

Phase 2 = check digit defined as a function of all other IMEI digits

Other label number configurations present are:

- **TRANSCIVER NUMBER:** Identifies the product type. Normally the SWF number. (i.e. V100).
- **PACKAGE NUMBER:** Identifies the equipment type, mode, and language in which the product is shipped.

Telephone Identification

Identification Label

Each Motorola GSM phone is labeled with a variety of identifying numbers. Figure 16 describes the current identifying labels.

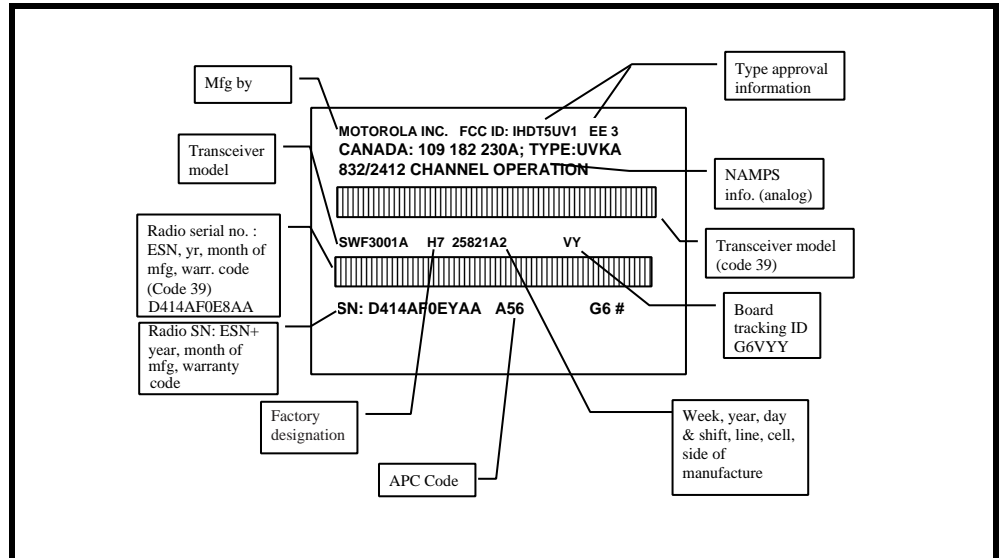

0204630



Figure 19. Telephone Identification Label

Troubleshooting

Manual Test Mode

Motorola 790 telephones are equipped with a manual test mode capability. This allows service personnel to verify functionality and perform fault isolation by entering keypad commands.

To enter the manual test command mode, a GSM / DCS test SIM must be used.

1. Press  to turn the phone OFF.
2. Remove the battery as described in the procedures.
3. Remove the customer's SIM card from the phone as described in the procedures.
4. Insert the test SIM into the SIM slot.
5. Replace the battery as described in the procedures.
6. Press  to turn the phone ON.

Manual Test Mode Commands

Table 3. Manual Test Commands

Key Sequence	Test Function/Name	Remarks
<Menu>048263*	Enter manual test mode	
"End" Key	Exit manual test mode	
54*	Suspend	Required for all Test Mode Operations
0*0*0	Select tone 0	
0*0*1	Select tone 1	
0*0*2	Select tone 2	
0*0*3	Select tone 3	
0*0*4	Select tone 4	
0*0*5	Select tone 5	
0*0*6	Select tone 6	
0*0*7	Select tone 7	
0*0*8	Select tone 8	
0*0*9	Select tone 9	
0*1*X	Disable tone X	
3*0*1	Enable vibrator	
3*0*0	Disable vibrator	
5*0*0	Set audio level 0	
5*0*1	Set audio level 1	
5*0*2	Set audio level 2	
5*0*3	Set audio level 3	
5*0*4	Set audio level 4	
5*0*5	Set audio level 5	
5*0*6	Set audio level 6	
5*0*7	Set audio level 7	

Table 3. Manual Test Commands (Continued)

Key Sequence	Test Function/Name	Remarks
5*0*8	Set audio level 8	
5*0*9	Set audio level 9	
5*0*10	Set audio level 10	
5*0*11	Set audio level 11	
5*0*12	Set audio level 12	
5*0*13	Set audio level 13	
5*0*14	Set audio level 14	
5*0*15	Set audio level 15	
6*2*2*0*0	Set Audio Path. Int Mic, IntSpk, RX unmute, TX unmute	
6*4*6*0*0	Set Audio Path. Boom Mic, Boom Spk, RX unmute, TX unmute	
10*0*3	Set band GSM 900	
10*0*4	Set band DCS 1800	
10*0*5		
10*0*6	Set dual band GSM 900 / 1800	
10*1*0	Read band	3= GSM 4= DCS 5= PCS 6 =GSM/DCS
18*0	Initialize non-volatile memory (Master Reset)	
18*1	Initialize non-volatile memory (Master Clear)	
55*2*001	Test Display. All pixels ON	
55*2*000	Test Display. All pixels OFF	
55*2*002	Test Display. Checkerboard pattern A	
55*2*003	Test Display. Checkerboard pattern B	
55*2*004	Test Display. Border pixels ON	
*#06#	IMEI Check	No Test Mode Required
Phone Set up --> Phone Status --> Other Information	Flex Version / Technology / S-W Version / Readiness Status	No Test Mode Required

Troubleshooting Chart

Table 4. Level 1 and 2 Troubleshooting Chart

Symptom	Probable Cause	Verification and Remedy
1. Telephone will not turn on or stay on.	a) Battery either discharged or defective.	Measure battery voltage across a 50 ohm (>1 Watt) load. If battery voltage is <3.25 Vdc, recharge the battery using the appropriate battery charger. If battery will not recharge, replace the battery. If battery is not at fault, proceed to b.
	b) Battery terminals open or misaligned.	Visually inspect battery terminals on both the battery and the telephone. Realign and, if necessary, either replace the battery or refer to a Level 3 Service Center for battery connector replacement. If battery terminals are not at fault, proceed to c.
	c) Transceiver board defective.	Remove the transceiver board assembly. Substitute a known good transceiver board and temporarily reassemble the phone. Press the Power/End key; if phone turns on and stays on, disconnect the dc power source and reassemble the phone with the new transceiver board. Verify that the fault has been cleared.
2. Telephone exhibits poor reception or erratic operation such as calls frequently dropping or weak or distorted audio.	a) Antenna defective.	Check connection between the antenna and the transceiver board. If the connection is OK, substitute a known good antenna. If the fault is still present, proceed to b.
	b) Transceiver board defective.	Replace the transceiver board (refer to 1c). Verify that the fault has been cleared and reassemble the phone with the new transceiver board.
3. Display is erratic, or provides partial or no display.	Transceiver board defective.	Replace the transceiver board (refer to 1c). Verify that the fault has been cleared and reassemble the phone with the new transceiver board.
4. Incoming call alert transducer audio distorted or volume is too low.	Faulty transceiver board.	Replace the transceiver board (refer to 1c). Verify that the fault has been cleared and reassemble the phone with the new transceiver board.
5. Telephone transmit audio is weak. (usually indicated by called parties complaining of difficulty in hearing voice).	a) Microphone defective.	Replace the microphone as described in the procedures. If fault is not cleared, proceed to b.
	b) Transceiver board defective.	Replace the transceiver board (refer to 1c). Verify that the fault has been cleared and reassemble the phone with the new transceiver board.
6. Receive audio from earpiece speaker is weak or distorted.	a) Connections to or from transceiver board defective.	Check connection from the earpiece to the transceiver board. If connection is not at fault, proceed to b.
	b) Earpiece speaker defective.	Temporarily replace the speaker with a known good speaker. Ensure good connection. Place a call and verify improvement in earpiece audio. If fault is cleared, reassemble the phone with the good transceiver board. If fault is not cleared, proceed to c.
	c) Transceiver board defective.	Replace the transceiver board (refer to 1c). Verify that the fault has been cleared and reassemble the phone with the new transceiver board.

Table 4. Level 1 and 2 Troubleshooting Chart (Continued)

Symptom	Probable Cause	Verification and Remedy
7. Vibrator feature not functioning.	a) Vibrator defective.	Replace vibrator. If the fault has not been cleared, proceed to b.
	b) Transceiver board defective.	Replace the transceiver board (refer to 1c). Verify that the fault has been cleared and reassemble the phone with the new transceiver board.
8. Internal Charger not working.	Faulty charger circuit on transceiver board.	Test a selection of batteries in the rear pocket of the desktop charger. Check LED display for the charging indications. If these are charging properly, then the internal charger is at fault. Replace the transceiver board assembly (refer to 1c). Verify that the fault has been cleared and reassemble the phone with the new transceiver board assembly.
9. No or weak audio when using headset.	a) Headset plug not pushed in fully.	Ensure the headset plug is fully seated in the jack.
	b) Faulty jack on transceiver board.	Replace the transceiver board (refer to 1c). Verify that the fault has been cleared and reassemble the phone with the new transceiver board.

Part Numbers

The following section provides a reference for the parts associated with E1 telephones.

Exploded View Diagram

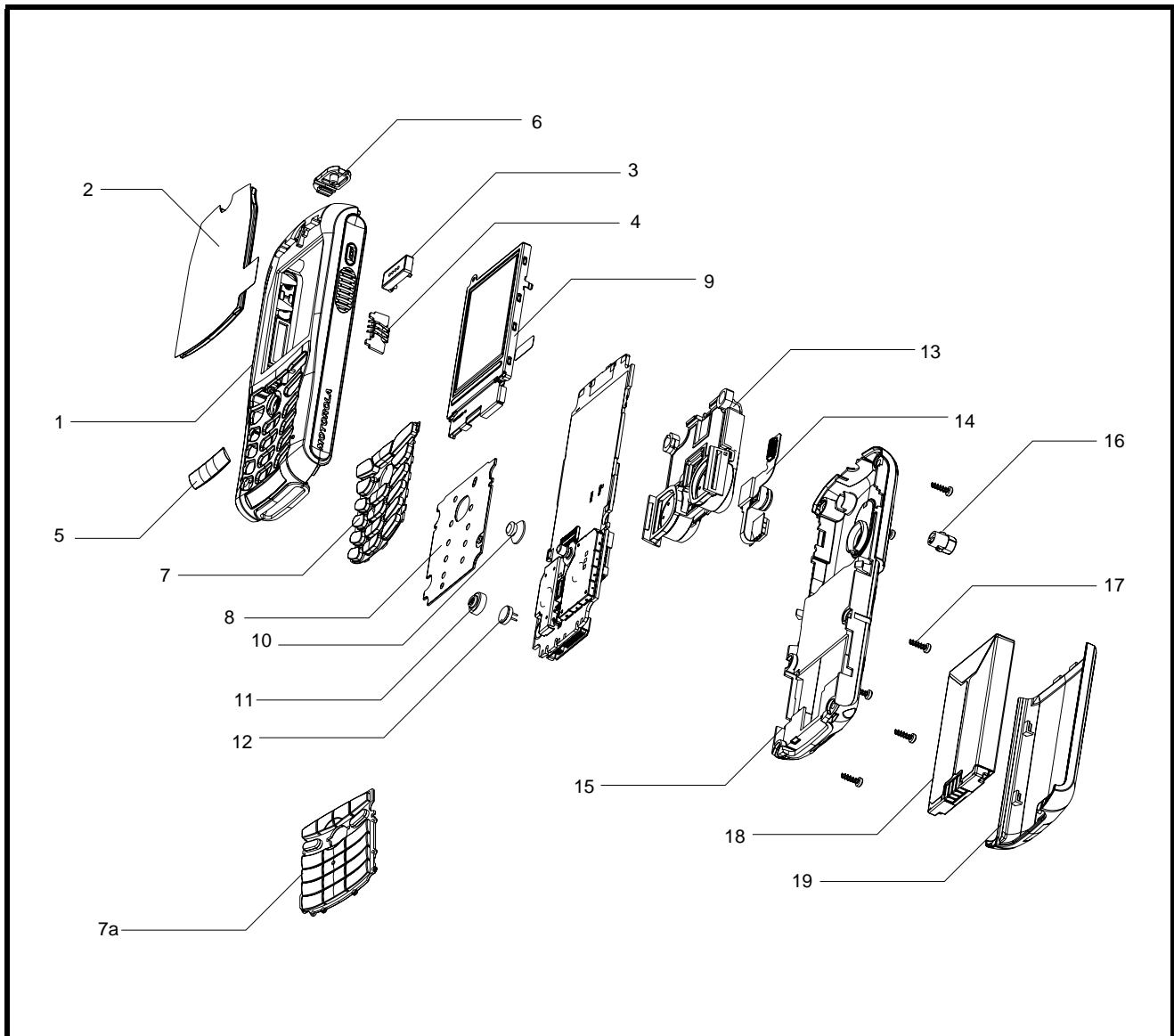

Figure 20. Exploded View Diagram

Exploded View Parts List

Table 5. Parts list

Item	Motorola Part Number	Description
1	1589893N09	Front Housing Soft Touch Black
2	6189782N01	Lens (Soft Touch Black)
3	5089574N01	Speaker
4	4089521N01	Volume BTN Switch
5	1389787N25	Escutcheon (Soft Touch White)
6	0589579N03	HS Grommet
7	3889743N03	Keypad English 3 Key
7a	3887683Y01	Keypad English 4 Key
8	0189678N02	Keyboard PCB 3 Key
8	0187816Y01	Keyboard PCB 4 Key
9	7289638N01	Display Assy

Item	Motorola Part Number	Description
10	1587437Y01	Joystick Cap
11	0589598N01	Mic. Grommet
12	5087974K02	Microphone
13	1589605N02	Chassis Speaker Assy
14	0189619N03	Camera Assy
15	1589794N06	Rear Housing
16	0589731N02	RF Grommet
17	0309315B23	Screw long (2)
17	0309315B24	Screw short (4)
18	SNN5699A	Battery
19	SHN8651	Battery Door (Soft Touch White)
-	6087603L01	RTC Battery



There is a danger of explosion if the Lithium ion battery pack is replaced incorrectly. Replace only with the same type of battery or equivalent as recommended by the battery manufacturer. Dispose of used batteries according to the manufacturer's instructions.

To order parts please use the following link:

<https://accesssecure.mot.com>

(Password is required)

Accessories

Table 6. List of Accessories

Description	Kit number
Audio & Connectivity	
Headset - Customizable	SYN0486
Headset - Neckloop	SYN7875
Headset - Retractable	SYN8284
Headset Stereo FM - CE Bus	SYN8609
Headset Boom Mic Noise Cancel - Universal	SYN8908
Headset Mono 4 Color Customizable - Universal	SYN9748
Headset Mono Customizable - Universal	SYN9350
Headset Mono Earbud - Trans Blue	AAYN4207
Headset Mono Earbud - Universal (Black)	SYN8390
Headset Mono Earbud - Universal (Silver)	AAYN4264
Headset One Touch 4 Color Customizable - Universal	SYN9749
Headset One Touch Customizable - Universal	SYN9351
Headset One Touch w/ Send-End	SYN8419
Headset Retractable Mic - Universal	SYN9050
Headset Stereo One Touch Earbud	CHYN4516
Mobile Phone Tools	Region-specific
Plug-in Speaker GSM/TDMA	SPN5028
TransFlash Card with SD Adapter - 128 MB	SYN0943
TransFlash Card with SD Adapter - 16MB	SYN0940
TransFlash Card with SD Adapter - 256MB	SYN0944
TransFlash Card with SD Adapter - 32MB	SYN0941
TransFlash Card with SD Adapter - 512MB	SYN1293
TransFlash Card with SD Adapter - 64MB	SYN0942
Data Cable CE Bus/USB	AAKN4011
Data Cable CE Bus/USB	SKN6311
Bluetooth Products	
Bluetooth Mono Headset, Nickel- H500	SYN1290
Bluetooth Car Kit - Asia/Americas	S9642
Bluetooth Car Kit - Euro	S9643
Bluetooth Car Kit - HF850	SJ0014
Bluetooth Car Kit - IHF1000 - Americas/Asia	98676H
Bluetooth Car Kit - IHF1000 - EMEA	CFLN1232
Bluetooth Headset - Glossy Black - HS820	SYN9951
Bluetooth Headset - Green - HS820	SYN0945
Bluetooth Headset - Grey - HS820	SYN1106
Bluetooth Headset - HS850 (Paladin Refresh - Black)	SYN1107
Bluetooth Headset - HS850 (Paladin Refresh - Blue)	SYN1226
Bluetooth Headset (Genie Refresh) - HS815	SYN1201
Bluetooth Headset (Genie) - HS801	CHYN4590
Bluetooth Headset (Mage) - HS830	SYN0996
Bluetooth Headset (Nexus) - HS805	SYN0986
Bluetooth Headset (Paladin) - HS810	SYN9826

Table 6. List of Accessories (Continued)

Description	Kit number
Bluetooth Helmet Headset - HS830 (Mage)	SYN0997
Bluetooth PC USB Adapter	SYN0717
Bluetooth Speaker (Quadrant Refresh) - HF820	SYN0736C
Bluetooth Speaker Quadrant - HF800	SYN0736
Consumer Personalization	
In-Vehicle Solutions	
Vehicle Power Adapter CE Bus - VC600	SYN0707
Vehicle Power Adapter CE Bus - VC610	SYN0780
Vehicle Power Adapter Rapid- CE Bus	SYN7818
Hang-up Cup - E398	SYN0826
Hang-up Cup - E398	SYN0827
Professional Install Car Kit Without Hang-up Cup	S9950
Self Install Car Kit - Smart Drive - Generic	SYN1135
Self Install Car Kit - Smart Drive+ - Generic	SYN1136
Self Install Car Kit Retractable CE Bus - HF600	SYN0613
Smart Cable CE Bus - Motorola	SYN1004
Power Solutions	
Charger Adapter CE/CE (Y-cable)	SKN6180
Travel Charger CE Bus Mid-Rate Linear - Euro	SPN4993
Travel Charger CE Bus Mid-Rate Linear - PRC	SPN4995
Travel Charger CE Bus Mid-Rate Linear - UK	SPN4994
Travel Charger CE Bus Mid-Rate Linear - US	SPN4992
Travel Charger CE Bus Mid-Rate Linear - US	SPN5115
Travel Charger CE Bus Mid-Rate Switcher - Argentina	SPN4739
Travel Charger CE Bus Mid-Rate Switcher - Argentina	SPN5043
Travel Charger CE Bus Mid-Rate Switcher - Australia	SPN4745
Travel Charger CE Bus Mid-Rate Switcher - Australia	SPN5045
Travel Charger CE Bus Mid-Rate Switcher - Brazil	SPN4741
Travel Charger CE Bus Mid-Rate Switcher - Brazil	SPN5044
Travel Charger CE Bus Mid-Rate Switcher - Euro	SPN5038
Travel Charger CE Bus Mid-Rate Switcher - Hong Kong	SPN4756
Travel Charger CE Bus Mid-Rate Switcher - India	SPN5046
Travel Charger CE Bus Mid-Rate Switcher - Korea	SPN4744
Travel Charger CE Bus Mid-Rate Switcher - Korea	SPN5042
Travel Charger CE Bus Mid-Rate Switcher - Mexico	SPN5041
Travel Charger CE Bus Mid-Rate Switcher - PRC	SPN4977
Travel Charger CE Bus Mid-Rate Switcher - PRC	SPN5040
Travel Charger CE Bus Mid-Rate Switcher - TWN	SPN5264
Travel Charger CE Bus Mid-Rate Switcher - UK/HK	SPN5039
Travel Charger CE Bus Mid-Rate Switcher - US	SPN4940
Travel Charger CE Bus Mid-Rate Switcher - US	SPN5037
Travel Charger CE Bus Mid-Rate Switcher - US	SPN5183
Travel Charger CE Bus Mid-Rate Switcher - US (VZN)	SPN5236
Travel Charger CE Bus Rapid Switcher - Argentina	SPN5055
Travel Charger CE Bus Rapid Switcher - Brazil	SPN5056

Table 6. List of Accessories (Continued)

Description	Kit number
Travel Charger CE Bus Rapid Switcher - Hong Kong	SPN5051
Travel Charger CE Bus Rapid Switcher - Japan - vdkk	SPN5252
Travel Charger CE Bus Rapid Switcher - Japan	SPN5072
Travel Charger CE Bus Rapid Switcher - Korea	SPN5054
Travel Charger CE Bus Rapid Switcher - Mexico	SPN5247
Travel Charger CE Bus Rapid Switcher - PRC	SPN5052
Travel Charger CE Bus Rapid Switcher - US	SPN5049
Travel Charger CE Bus Rapid Switcher - US	SPN5195
Travel Charger CE Bus Rapid TWN Bag	SPN5265
Travel Charger CE Bus Rapid TWN Box	SPN5266
Battery Only Charger - E1	AAPN4072
Desktop Charger Modular CE Bus Dual Pocket	SPN5210
Desktop Charger Modular CE Bus Single	SPN5204

Related Publications

Motorola E1 User's Guide (English)

68xxxxx100

Programming: Software Upgrade and Flexing

Contact your local technical support engineer for information about equipment and procedures for flashing and flexing.

A

alert settings 16
antenna contact bumper, removing and replacing 30, 31, 32

B

battery
 charge indicator 17
 function 17
battery, removing and replacing 20, 21

C

caller ID 11
Canadian Interference-Causing Equipment regulations 5
copyrights
 computer software 6

D

disassembly 20

E

exploded view diagram 39
exploded view parts list 40

F

FCC rules 5
features
 caller ID 11
front endo housing, removing and replacing 26
front speaker, removing and replacing 27

I

identification
 international mobile station equipment identity 34
 mechanical serial number 33
 product 5
identification, labels 33, 35
IMEI 34
Introduction 5

K

keypad PC board, removing and replacing 28

L

LCD 14
liquid crystal display (LCD) 14

M

manual test mode 36
menu structure 16
microphone, removing and replacing 26
MSN 33

N

names
 product 5

O

operation 14
 alert settings 16
 battery 17
 controls, indicators, and I/O connectors 14
 icons 15
 alarm 15
 real-time clock 15
 LCD 14
 menu navigation 14
 menu structure 16
operations
 icons
 soft keys 15
overview, product 11

P

parts
 exploded view diagram 39
 exploded view parts list 40
Parts Replacement 8
product
 identification 5
 names 5
product overview 11
 features 11
publications, related 43

R

Rear housing cover, removing and replacing 20
regulatory agency compliance 5
related publications 43
Removing
 transceiver PC board 28
removing
 antenna contact bumper 30, 31, 32
 battery 17, 20, 21
 front endo housing 26

- front speaker 27
- keypad PC board 28
- microhpone 26
- rear housing cover 20
- transceiver board 26
- replacing
 - antenna contact bumper 30, 31, 32
 - battery 20, 21
 - front endo housing 26
 - front speaker 27
 - keypad PC board 28
 - microphone 26
 - rear housing cover 20
 - transceiver board 26
 - transceiver PC board 28

S

- serial number
 - mechanical 33
- service manual
 - about 6
 - audience 6
 - conventions 7
 - scope 6
- service policy 7
 - customer support 7
 - out of box failure 7
 - product support 7
- shut down
 - upon battery removal 17
- SIM, description 33
- specifications 9
- subscriber identity module (SIM) 33
- support
 - customer 7
 - product 7

T

- test equipment 19
- tools, disassembly 19
- transceiver board, removing and replacing 26
- transceiver PC board, removing and replacing 28
- troubleshooting 36
 - manual test mode 36
 - troubleshooting chart 37

W

- warranty service 7

MOTOROLA, the Stylized M Logo, and all other trademarks indicated as such herein are trademarks of Motorola, Inc.

® Reg. U.S. Pat. & Tm. Off.

© 2005 Motorola, Inc.

All rights reserved.

Personal Communications Sector,
789 International Parkway, Room S2C
Sunrise, FL 33325-6220.



6809495A42-O