

MOTOROLA CONFIDENTIAL PROPRIETARY

4 1 3 A

Engineer:	MOTOROLA INC.		
Drawn by:			
R&D CHK:	TITLE:	Size: 11x17	
DOC CTRL CHK:	SIRIUS IA Keypad		
MFG CTRL CHK:	REV:	Drawing Number:	Page: Of:
QA CHK:	Date:	Time:	
Changed by:			

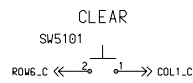
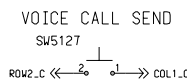
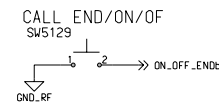
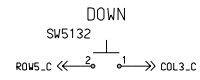
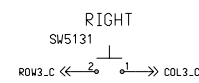
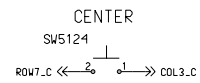
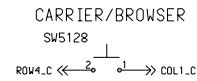
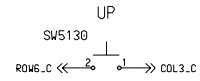
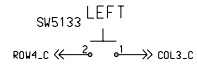
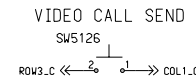
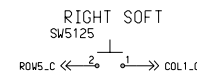
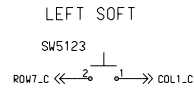

Left Side Keys

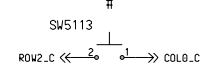
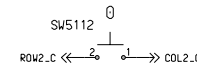
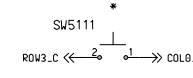
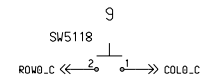
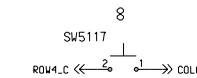
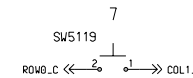
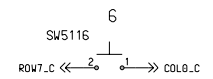
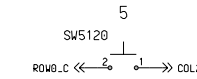
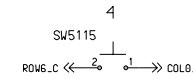
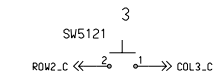
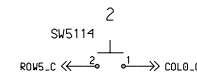
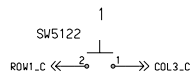
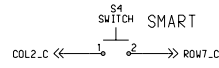
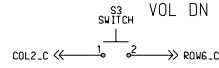
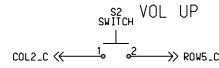

Right Side Keys

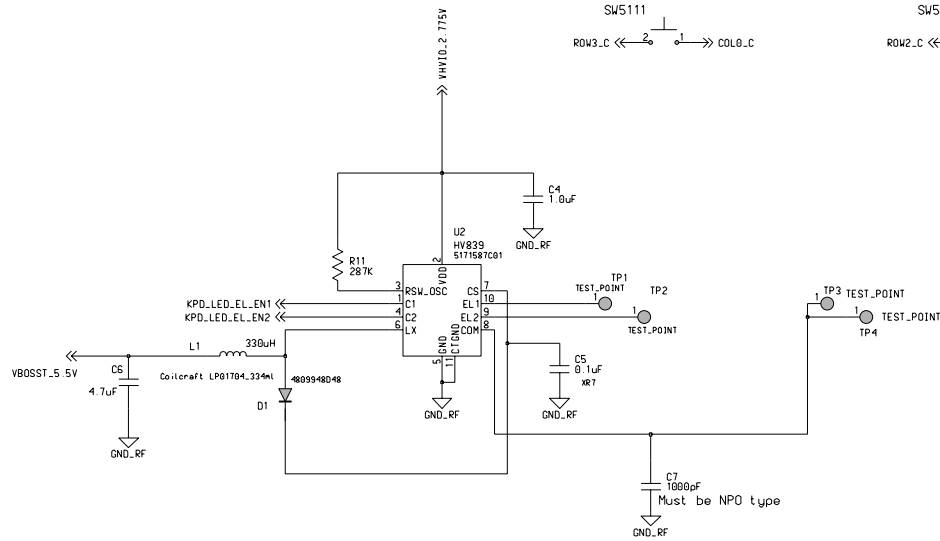
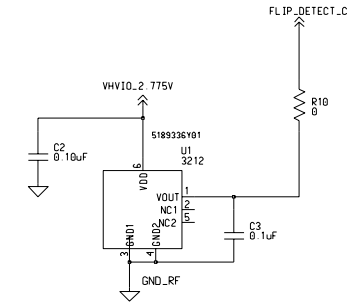
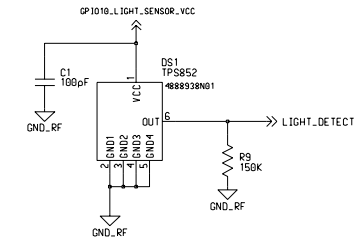
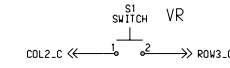
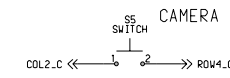

2 POLE IMPLEMENTATION FOR THE KEYPAD AND SIDE KEYS

	ROW7	ROW6	ROW5	ROW4	ROW3	ROW2	ROW1	ROW0
COL 0	6	4	2	8	*	#		9
COL 1	Left Soft	CLEAR	Right Soft	Carrier	Video Call Send	Voice Call Send		7
COL 2	SMART	Vol Down	Vol Up	Camera	VR	0		5
COL 3	Nav Center	Nav Up	Nav Down	Nav Left	Nav Right	3	1	

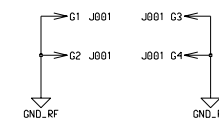
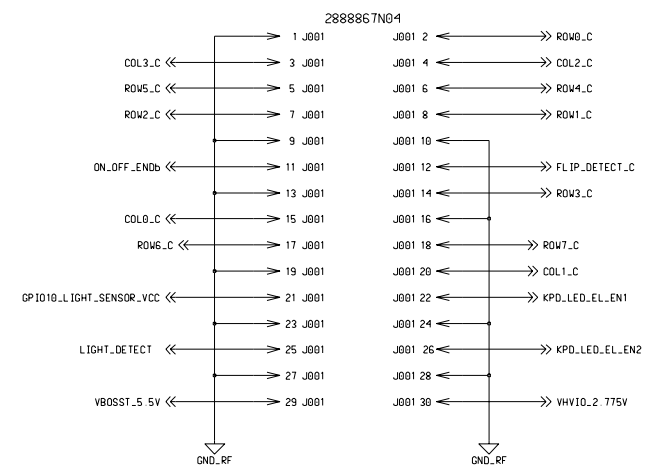

A

B

C

D