



Technical Support Group

*Prepared for Motorola PCS*  
**Field Service**  
**Centres**

## V3-Razr Repair Manual



April 2005  
KS-042050-V1.2  
D54

# TABLE OF CONTENTS

<b>MODULE 1</b>	<b>2</b>
<i>TECHNOLOGY</i>	3
<i>GSM OVERVIEW</i>	3
PREFACE	3
SYSTEM ARCHITECTURE	3
<i>PRODUCT FUNCTIONALITY</i>	6
<i>FEATURES</i>	6
<b>MODULE 2</b>	<b>9</b>
<i>PARTS LIST</i>	10
MOL	11
REPAIR CATEGORIES	12
LABOUR RATES	13
<b>MODULE 3</b>	<b>14</b>
<i>ASSEMBLY &amp; DISASSEMBLY</i>	15
<i>KNOWN ISSUES &amp; RESOLUTIONS</i>	26
SERVICE WEBSITE	28
REPAIR CODES	29
CLAIMABLE PARTS	29
<b>MODULE 4</b>	<b>30</b>
<i>TEST EQUIPMENT</i>	31
SOFTWARE	32
ACCESSORIES	33

# MODULE 1

- *-Technology*
- *-Product functionality*
- *-Features*

# Technology

## GSM overview

### Preface

This page discusses the GSM mobile telephony system, which is increasingly popular and established throughout the world. The term **GSM** usually means the GSM standard and protocols in the frequency spectrum around 900MHz. There is also DCS1800 - GSM protocols but at different air frequencies around 1800 MHz - and in the United States, where spectrum for Personal Communication Services (PCS) was auctioned at around 1900MHz, operators using the aptly-named GSM1900 are competing against a plethora of other standards. As a result of this, the original and most widely-used GSM frequency implementation is also becoming known as GSM900, and DCS1800 is also known as GSM1800. However, although the physical frequencies used differ, the protocols and architecture remain the same.

### System architecture

**Figure 4** below shows the GSM system architecture, which consists of the switching system, the base station system and the user equipment.

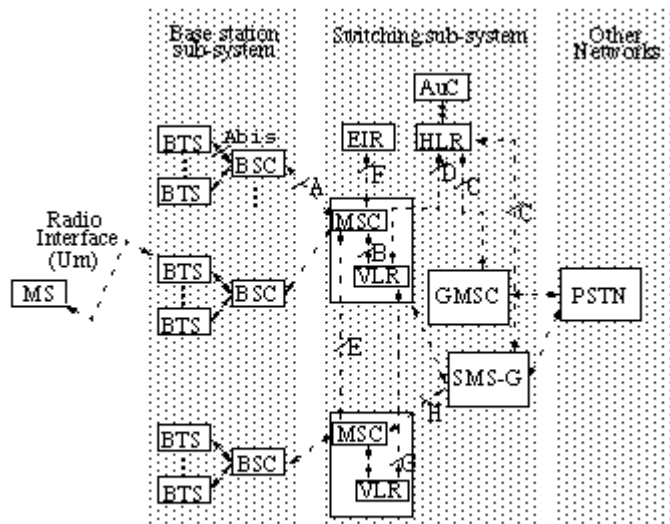

**Figure 4:** The GSM system architecture

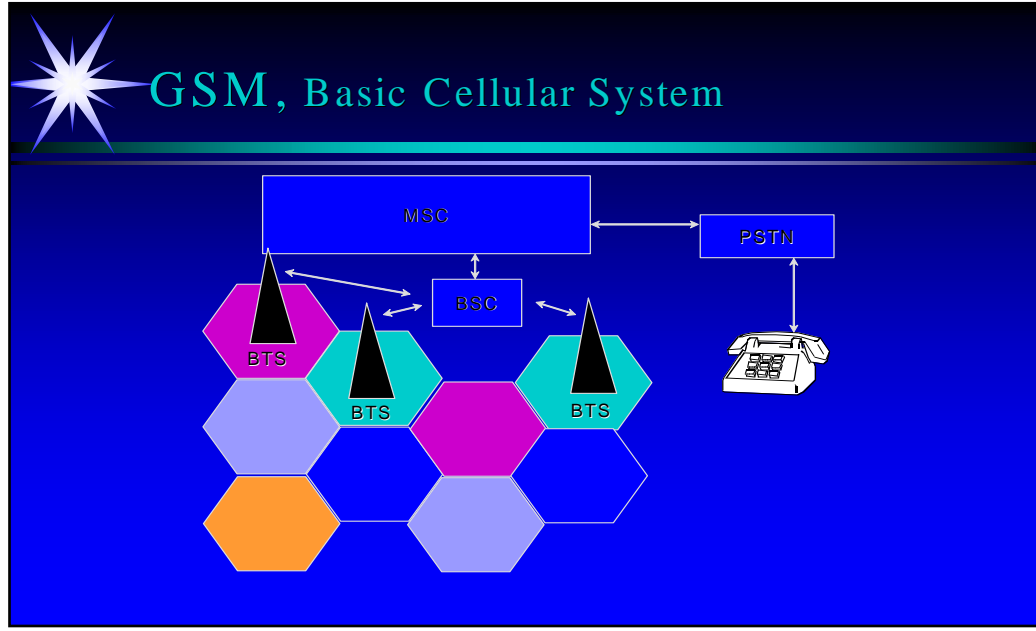

Area divided up into Cells each with its own Base Transceiver station (BTS) which operates on its own set of frequencies  
The BTS are controlled by their own BSC (Base station controller) which can control multiple BTS  
The BSC is connected to the MSC (usually by land line) so the digital over air connection is from the Mobile to the BTS, the link from the BTS to the BSC can also be by land line.  
MSC : Mobile Switching Centre acts as the interface to the PSTN.

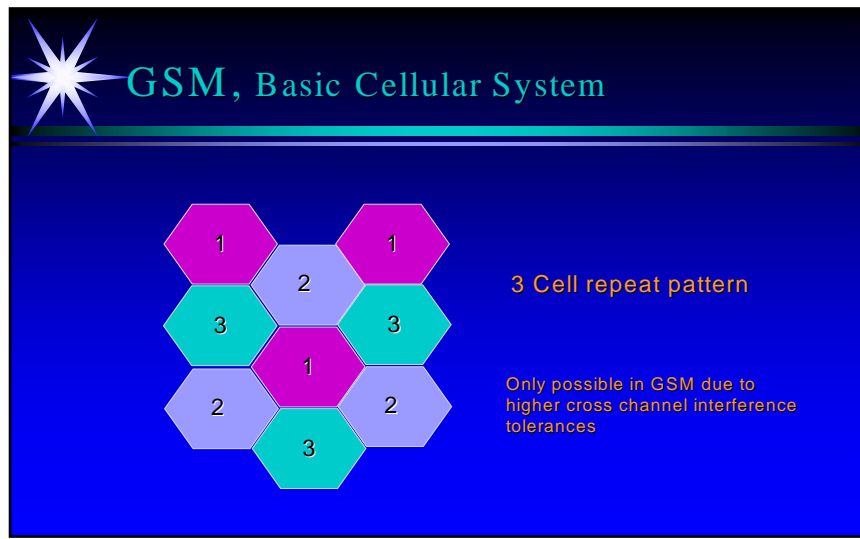

3 cell repeat: possible in GSM due to higher tolerance to cross channel interference. digital timing specs etc.  
Other patterns apply.

## **Product Functionality**

- **Form Factor:** Clamshell
- **Finish:** Tri-coated paint, colour TBD
- **Bands/Modes:** GSM : 850/900/1800/1900  
GPRS Class 10
- **Size:** 63 cc
- **Weight:** 90g
- **Dimensions:** 98 x 53 x 15
- **Display:** 176 x 220 64K TFT internal  
96 x 80 4K CSTN external
- **Antenna:** Internal
- **TT/SB Time:** TBD (700mAh Battery)
- **Audio** MIDI (24Ch/22Khz),  
MP3 Ring tones

## **Features**

- Superior Design and CMF
- Internal Quad-Band Antenna
- External Picture caller ID
- Integrated VGA camera
- Integrated Class 1 Bluetooth™
- 22kHz MIDI and polyphonic speaker
- MPEG4 video playback
- 3D Graphics Engine
- UI Skinning
- SyncML
- Mini-USB connector

## Physical Overview

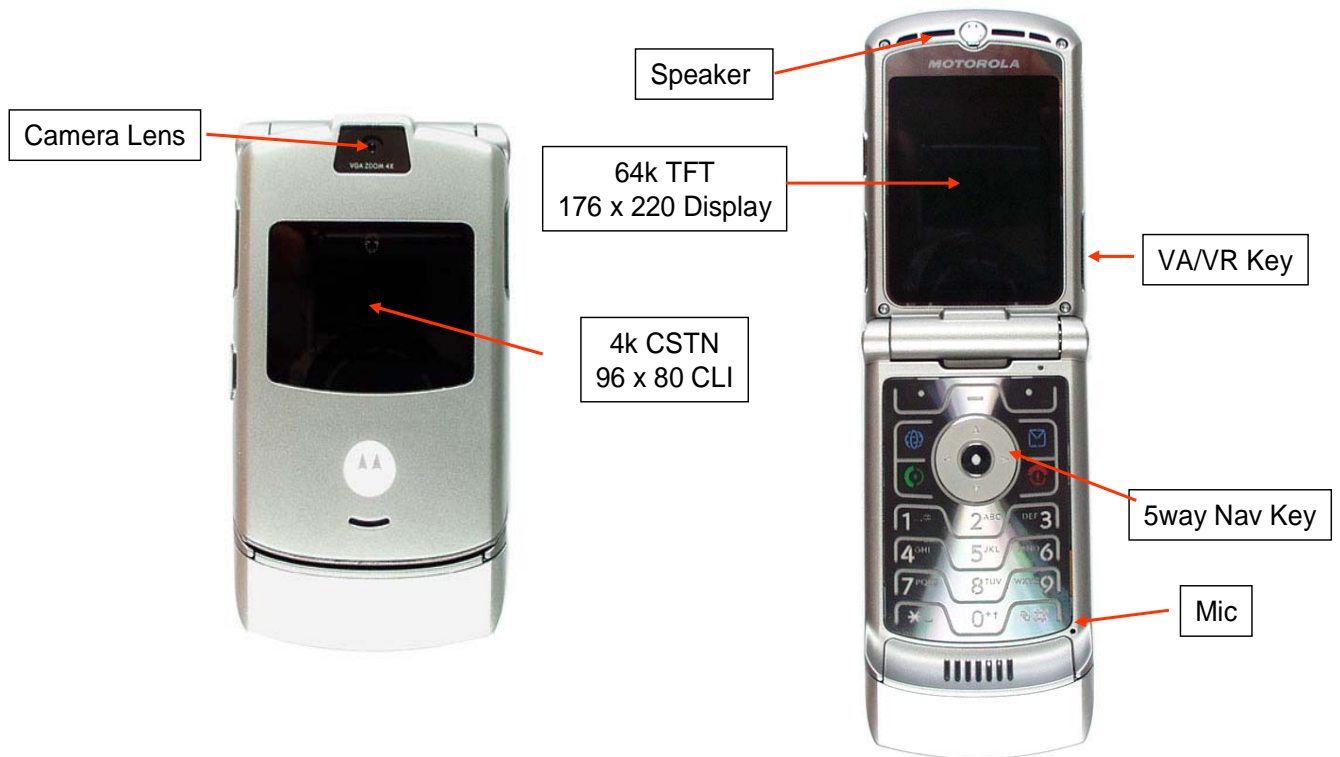

## Physical Overview (Cont'd)





## **MODULE 2**

- *-Piece Parts*
- *-Motorola on line(MOL)*
- *-Repair Categories*
- *-Labour Rates*

# Parts List

## Exploded View Diagram: V3

V3-GSM

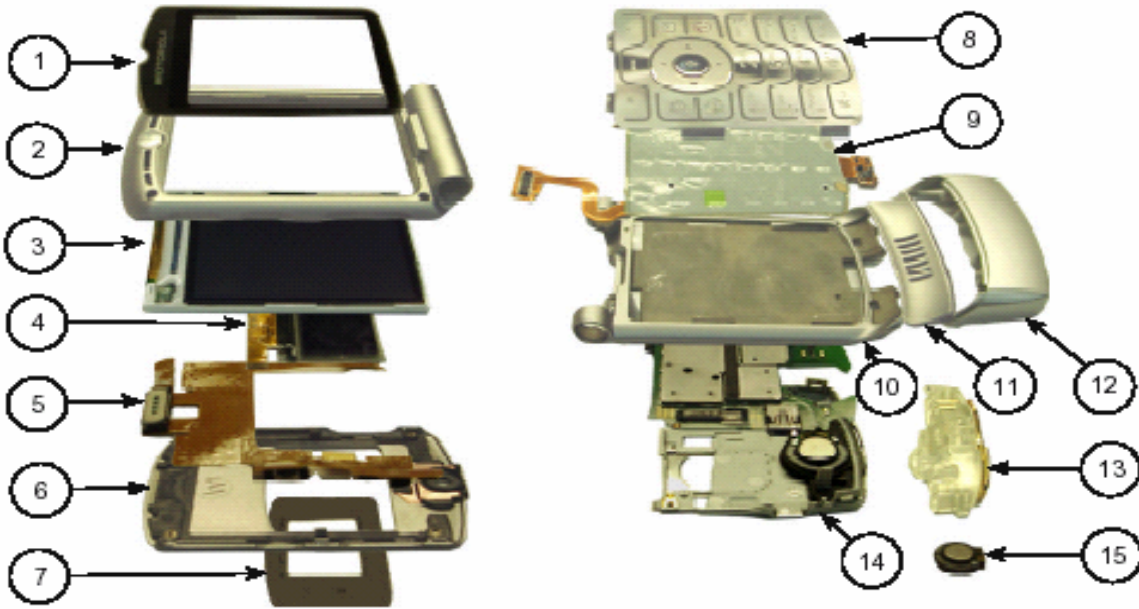

<u>Part Description</u>	<u>Part Number</u>
1-Lens	6190016N03
2-Front Flip housing	1590025N02
3-Display Module	7290086N01
4-Display Call ID	7287518Y01
5-Flex Circuit	8490007N01
6-Flip Housing Back	0790000N01
7-Lens Caller ID	6190015N02
8-Keypad	3888182Y03
9-Keyboard Assy.	8489976N02
10-Front Housing	1590043N01

<u>Part Description</u>	<u>Part Number</u>
11-Front grill	p/o Front housing
12-Antenna Cover	p/o Front Housing
13-Antenna	1590051N03
14-Back Housing	1590048N01
15-Midi Speaker	5088017N02

All piece parts and prices for the V3 model are available when you log into the Motorola on-line system (MOL)

## **Motorola On Line (MOL)**

**To Place your piece parts order please log in to:**

<http://businessonline.motorola.com>

You will be asked to enter your Motorola on-line Logon ID and Password.

**Part numbers and prices are subject to change without notice.  
Please reference the terms and conditions on the MOL website.**

**If you do not have login ID and password:**

Please see signup information on MOL startup page.

You will need to provide the following Information:

- (A) Your company name
- (B) Your company ship to address
- (C) Your company billing address
- (D) Contact name

## **Repair Categories**

### **There are Seven (7) repair categories**

- (1) Major repairs – REP01- e.g. Major component replacement.
- (2) Minor Repairs – RMP01 or RPR01- Simple component replacement – e.g. Non- soldered parts.
- (3) Basic Repairs – RSP01 or RAS01 - e.g. Re-solder simple components, clean contacts.
- (4) Batt repair – RBT01 – e.g test and or replace battery
- (5) Software – SWU01 – e.g Flashing, force flashing
- (6) Antenna - RAN01 – e.g test and or replace antenna.
- (7) Sent-mot - FWD01 - unknown or unauthorized repairs sent to Motorola or authorized service centre

The examples above are for reference only, each repair category contains many more items than are listed here. Motorola reserves the right to add, remove or change items in each repair category from time to time.

## Labour Rates

**Please refer to your warranty compensation schedule for warranty labour rates.**

**Motorola provides a limited warranty of twelve (12) months on the V3 phone. Proof of purchase must be provided in order to validate warranty.**

**In order to be paid for in-warranty repairs performed in your service centre you must submit a warranty claim through Motorola Service link system.**

### **NOTE:**

**Motorola will not reimburse the service centre for repairs performed on V3 units unless your technicians are trained on this specific model.**

## **MODULE 3**

- *-Assembly & Disassembly*
- *-Architecture*
- *-Known issues & resolutions*
- *-Service Website*
- *-Repair Codes*
- *-Claimable Parts*

Only technicians that are Motorola trained on the V3 model are allowed perform in-warranty repairs on the V3 phones.

## Disassembly & Assembly –V3 Razor

***This product contains static-sensitive devices. Use anti-static handling procedures to prevent electrostatic discharge (ESD) and component damage.***

### Removing and Replacing the Battery Housing and Battery

1. Ensure the phone is turned off.
2. Press in and hold the battery door latch as shown.

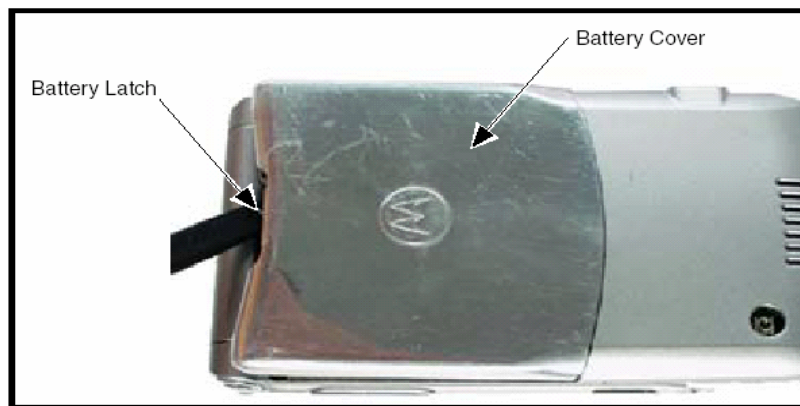

3. Rotate the battery cover upwards and lift it completely off the phone.

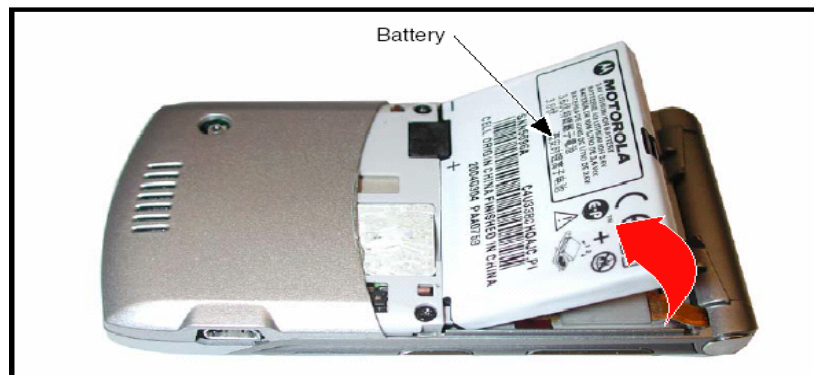

4. Lift the end of the battery first, and then remove it from the phone.
5. To replace, Align the battery with the battery compartment so the contacts on the battery match the battery contacts in the phone.
6. Insert the battery, contacts side first, into the battery compartment and push down followed by the opposite edge of the battery.

7. Insert the bottom edge of the of the battery cover into the rear housing, then push the top edge of the cover down and snap it into place.

### Removing and Replacing the Subscriber Identity Module (SIM)

1. Remove the battery cover and battery as described in the procedures.

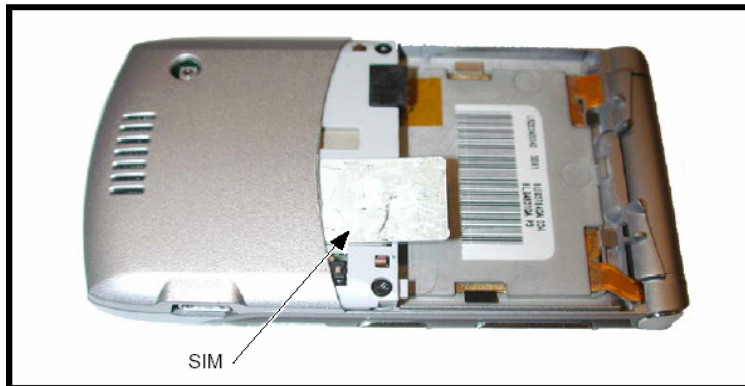

2. Slide the SIM card out of the phone as shown.
3. Carefully lift the SIM from the phones.
4. To replace, insert the SIM into the holder, ensuring the keyed corner of the SIM faces the outside of the phone.
5. Replace the battery and battery door as described in the procedures.

### Removing and Replacing the Rear Housing

1. Remove the battery cover, battery, and SIM as described in the procedures.
2. Using a Torx driver with a T-5 bit, remove the screws at each side of the phone. Retain the screws for reassembly..

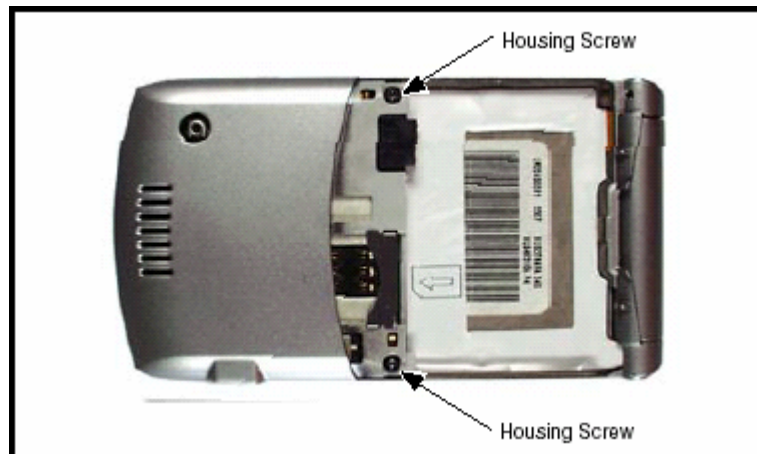



3. Release the four housing latches by inserting the pointed end of the plastic disassembly tool into the openings on the rear housing.

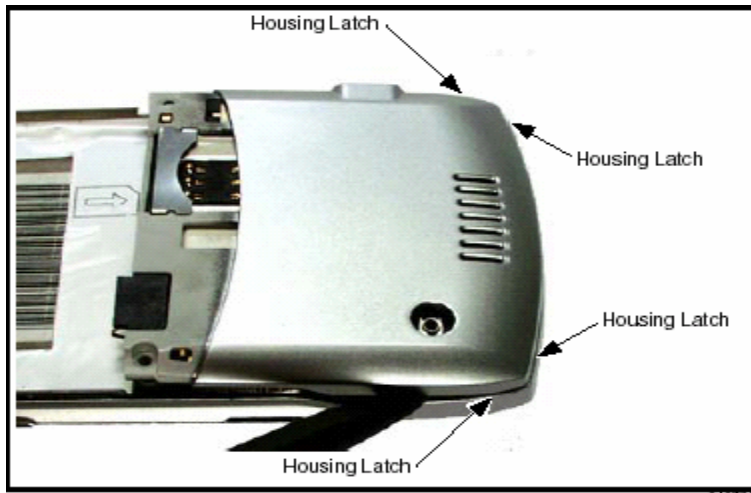

4. Carefully rotate the rear housing away from the front housing and flip assembly.

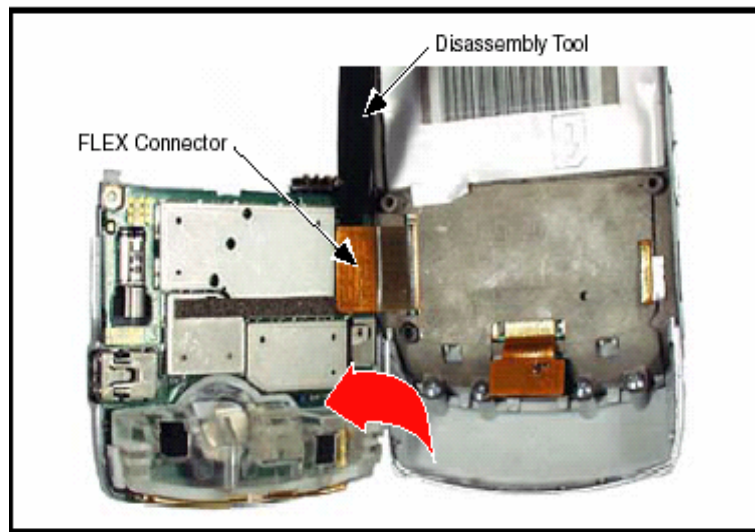

5. Use the disassembly tool to unseat the flex connector from it's socket.

6. Lift the rear housing assembly away from the phone.

7. To replace, carefully align the flex connector to it's socket on the rear housing assembly, then gently press down on the flex connector until it is properly seated in it's socket.

8. Rotate the rear housing assembly so it sits over the phone.

9. Align the housing latches with the corresponding openings on the front housing. Gently press the housings together until the catches snap into place.

10. Replace the 2 housing screws and tighten to a final torque setting of 1.5 inch pounds. Do not over tighten.
11. Replace the antenna, SIM, battery, and battery cover as described in the procedures.

### Removing and Replacing the Antenna

1. Remove the battery cover, battery, SIM, and rear housing assembly as described in the procedures.
2. Use the metal tweezers to grasp the rubber antenna grommets and carefully remove them from the antenna assembly. See Figure 7. Set the rubber grommets aside for reuse.

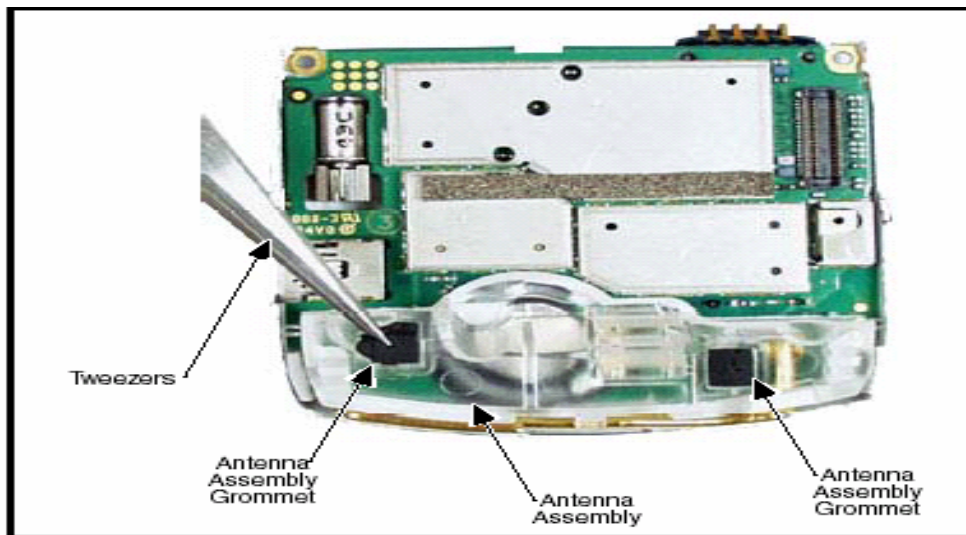
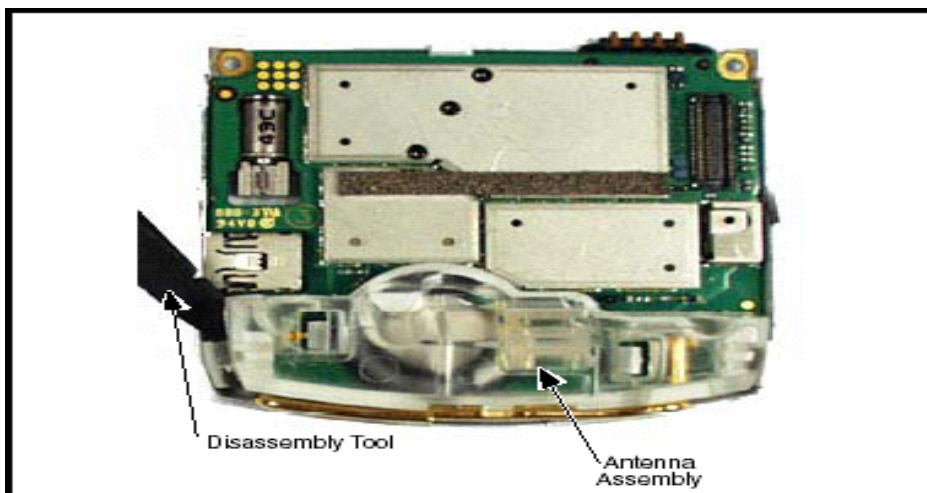

Fig7

3. Use the disassembly tool to release the antenna assembly as shown in Figure 8.



4. Carefully lift the antenna assembly away from the phone.
5. To replace, align the antenna assembly to the phone.
6. Carefully press the antenna assembly into position until the antenna assembly latches snap into position.
7. Reinstall the rubber antenna assembly grommets into their slots. Each antenna grommet is uniquely shaped to fit into its respective position.
8. Replace the rear housing assembly, SIM, battery and battery cover as described in the procedures.

### Removing and Replacing the Transceiver Board Assembly

1. Remove the battery cover, battery, SIM, antenna, rear housing and battery tray as described in the procedures.
2. Lift the transceiver board assembly out of the front housing with the metal tweezers. See Figure 9.

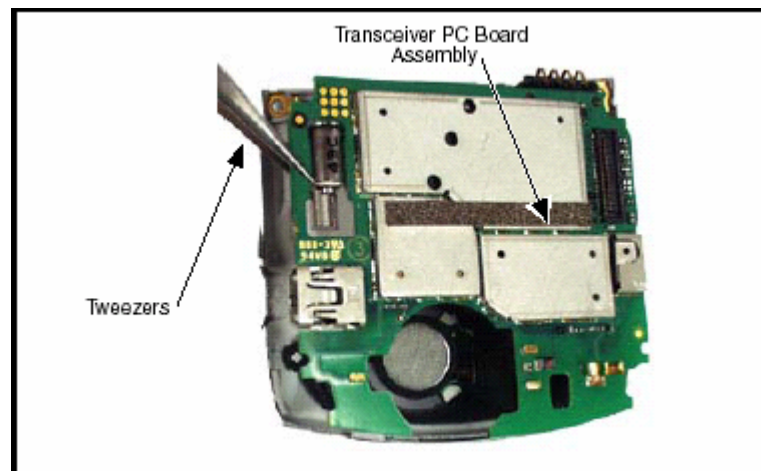

**Fig9**

3. To replace, insert the transceiver board assembly into the rear housing.
4. Carefully and gently press the transceiver board into position and until it snaps into place.
5. Replace the antenna assembly, rear housing, SIM, battery, and battery cover as described in the procedures.

### Removing and Replacing the Flip Assembly Cover

1. Remove the battery cover, battery, SIM, antenna, rear housing, and transceiver board assembly as described in the procedures.
2. Remove the 4 flip assembly screw caps.
3. Use the T-5 driver to remove the 4 screws from the flip assembly (see Figure10). Retain the screws for re-assembly.



**Fig10**

4. Before removing the flip cover, note the locations of the smart buttons on the sides of the flip assembly.
5. Use the disassembly tool to gently pry off the flip cover (see Figure 11).



**Fig 11**

6. Remove the smart buttons on the side of the flip assembly. Set them aside for reassembly.
7. Lift the flip cover away from the flip assembly. Be careful not to damage the display flex cable (see Figure 12).

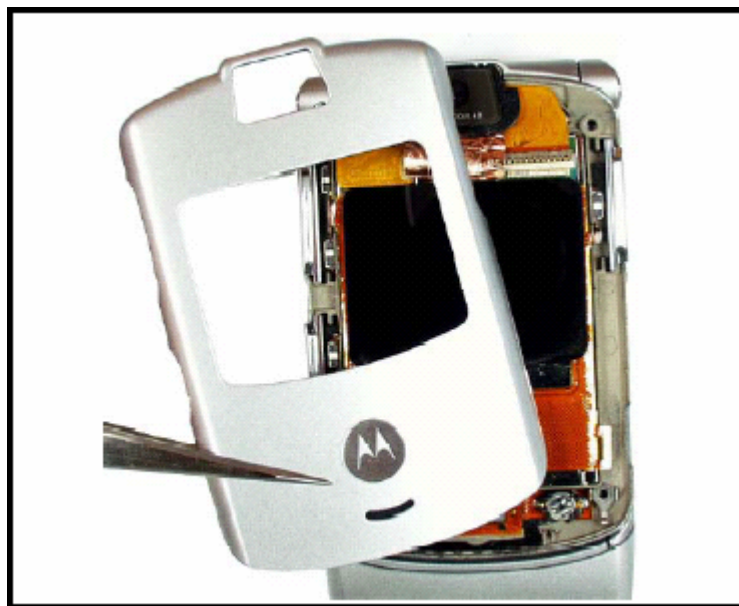
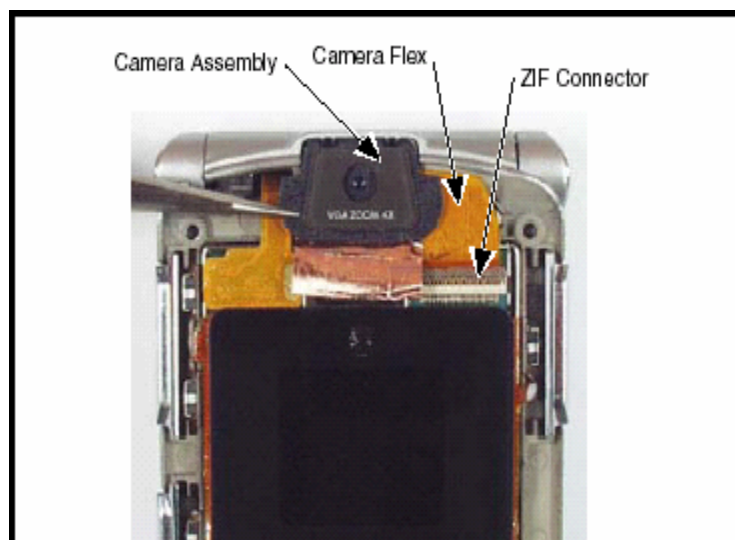

**Fig 12**

8. To replace, insert the smart buttons into the phone. Ensure the buttons contact their respective switches on the display assembly.
9. Align the flip cover to the flip assembly, gently press the flip cover onto the flip assembly until the flip cover latches engage.
10. Insert and tighten the 4 screws to secure the flip cover to the flip assembly. Avoid damage to the flex cable.
11. Insert the 4 rubber screw covers over the flip assembly screws.
12. Replace the transceiver board assembly, rear housing, antenna assembly, SIM, battery, and battery cover as described in the procedures.

### Removing and Replacing the Camera Assembly

1. Remove the battery cover, battery, SIM, antenna, rear housing, and transceiver board assembly, flip assembly cover, and CLI lens cover as described in the procedures.
2. Unlock the ZIF connector and remove the camera assembly flex connector.
3. Carefully lift the camera assembly and flex out of the flip assembly (see Figure 13).

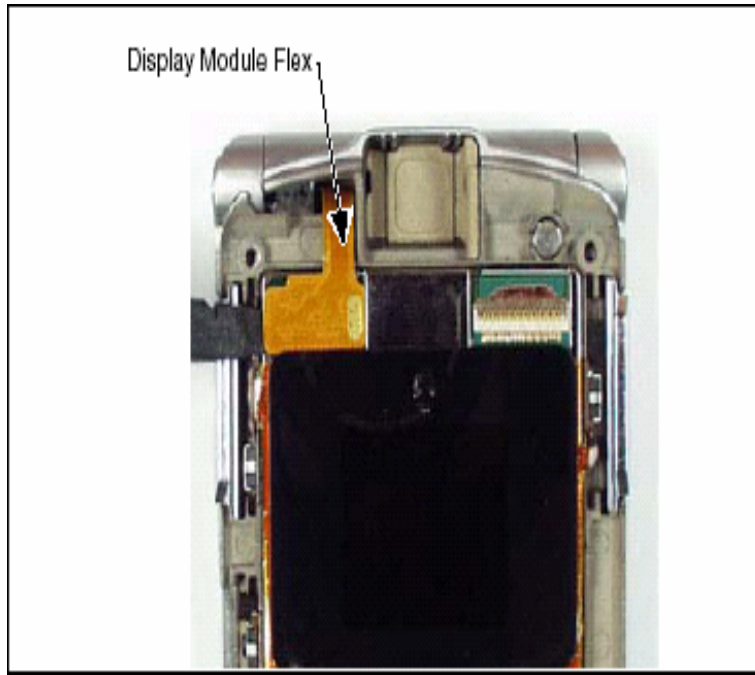

**Fig 13**

4. To replace, carefully press the camera assembly into its slot in the flip assembly.
5. Insert the end of the camera assembly flex cable into its slot in the ZIF connector on the flip display assembly. Avoid damage to the flex cable.
6. Replace the flip assembly cover, transceiver board, rear housing, antenna, SIM, battery, and battery cover as described in the procedures.

### Removing and Replacing the Display Module Assembly

1. Remove the battery cover, battery, SIM, rear housing, antenna, transceiver board assembly, flip assembly cover, and camera assembly, as described in the procedures.
2. Use the disassembly tool to unseat the display module assembly flex connector from its socket (see Figure 14)



**Fig 14**

3. Carefully and gently lift one corner of the display module assembly out of the flip assembly.
4. Avoid damage to the electrical components on the flex while carefully removing the display module assembly from the flip assembly.
5. Carefully lift the display lens away from the flip assembly.

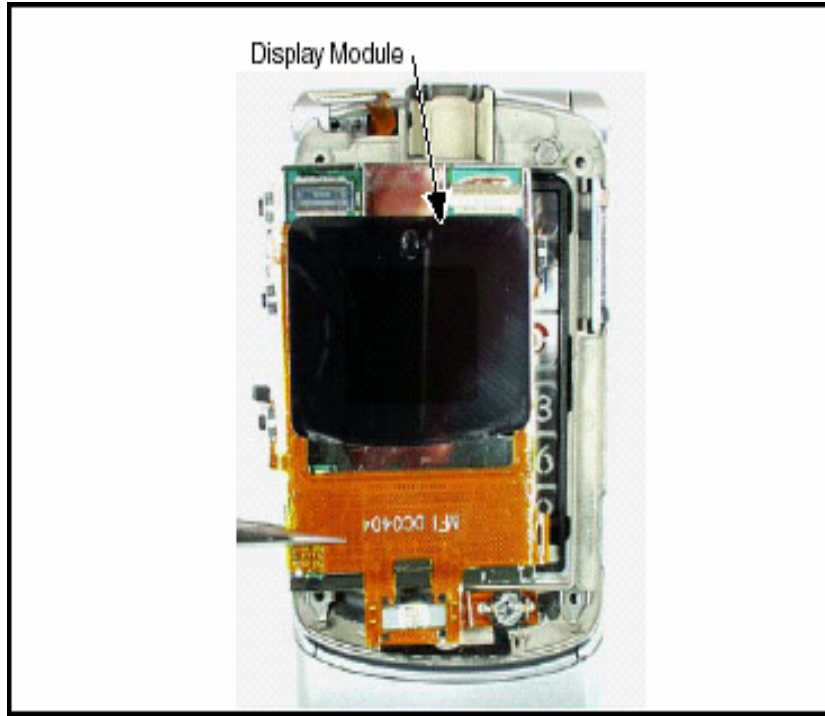
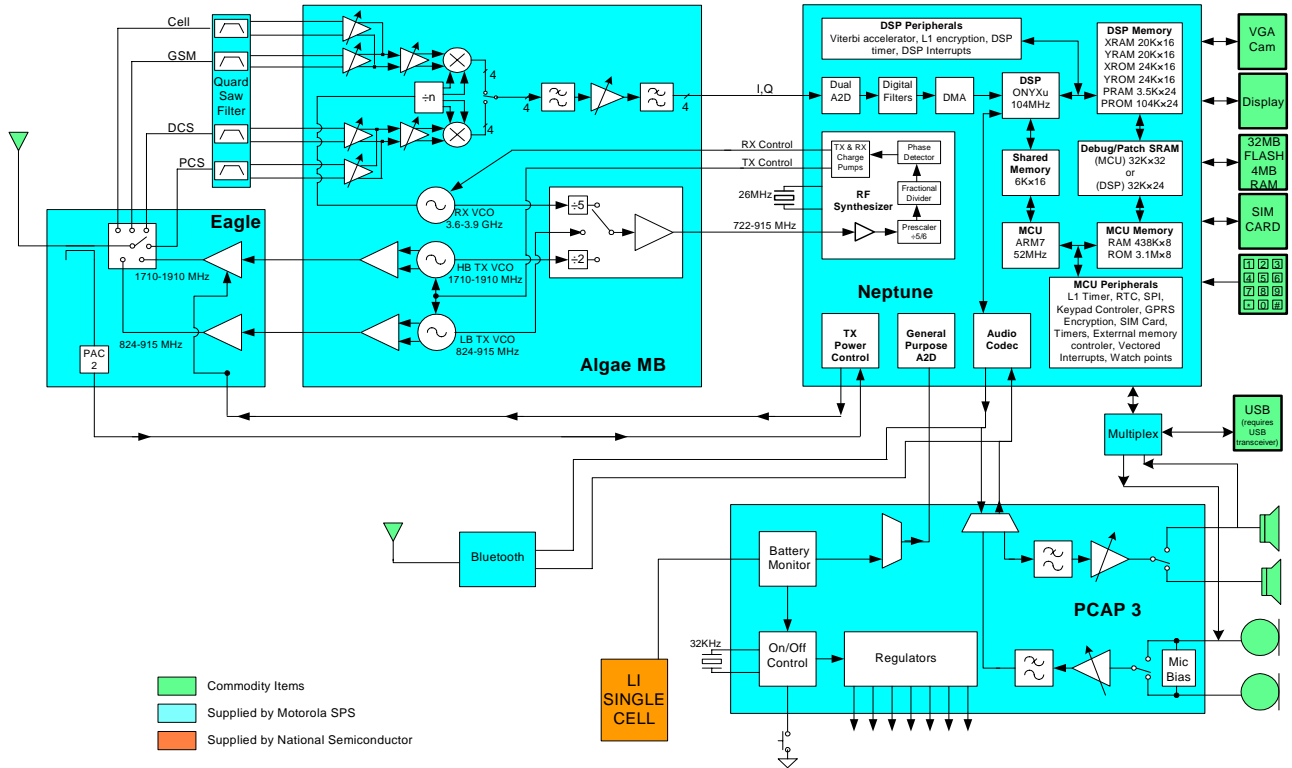

**Fig 15**

6. To replace, align the display module assembly to the flip assembly.
7. Carefully lower the display module into the flip assembly. Ensure that all of the display none of the display assembly components are damaged.
8. align the flip display flex to the flex connector on the flip display assembly and gently press down on the flex connector until properly seated.
9. Replace the camera assembly, flip assembly cover, transceiver board, rear housing, antenna, SIM, battery, and battery connector as described in the procedures.



# V3 Razr Block Diagram



## Bluetooth

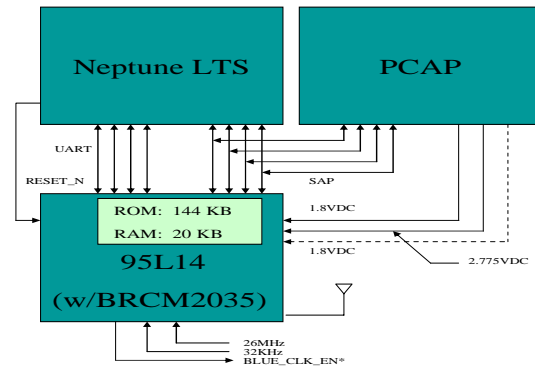

## Known Issues & Resolutions

### V3-Razr Known Issues

**The repairs listed in this section are the only repairs that are allowed to be performed on the V3 phone in the field. The repair code and the problem found code must be indicated on your service link claim for each repair or the claim will be rejected.**

<u>Customer Complaint</u>	<u>SVL problem found code</u>	<u>Root Cause</u>	<u>Resolution/ Service centre action</u>	<u>Repair code</u>	<u>Associated Part #</u>	<u>Repair Category</u>
Keypad does not function	MKP01	Gold pads on keypad misaligned with metal dome	Replace Keypad flex assembly	RMP01	8489976N02	Minor (02/22/05)
No Display	DIM01	Loose 40 pin display flex connector	Reconnect Flex	RAS01	8489976N02 Quantity = 0	Basic (02/22/05)
Missing lines on CLI Display	DIS02	Defective CLI Display	Replace Display Assembly	RMP01	7290086N01	Minor (02/22/05)
Missing lines on main Display	DIM02	Defective main Display	Replace Display Assembly	RMP01	7290086N01	Minor (02/22/05)
Short message time stamp incorrect	FTR10	Incorrect SMS time stamp	Upgrade software to current version	SWU09	NA	Software (03/30/05)
<b>Always Display Insert Sim</b>	<b>SIM01</b>	<b>Broken pin on SIM connector</b>	<b>Replace SIM Block / J-SIM connector</b>	<b>RMP02</b>	<b>3989888N01</b>	<b>Minor (04/20/05)</b>
<b>-Problem not listed - Unauthorized repair</b>	Use proper problem found codes. (not codes above)	N/A	Send to assigned repair centre	FWD01	NA	Send-mot

**All defective parts are subject to audit, if a claim is found with a part that is not defective the entire claim will be rejected.**

## V3- Razr Board Layout

### Top Side

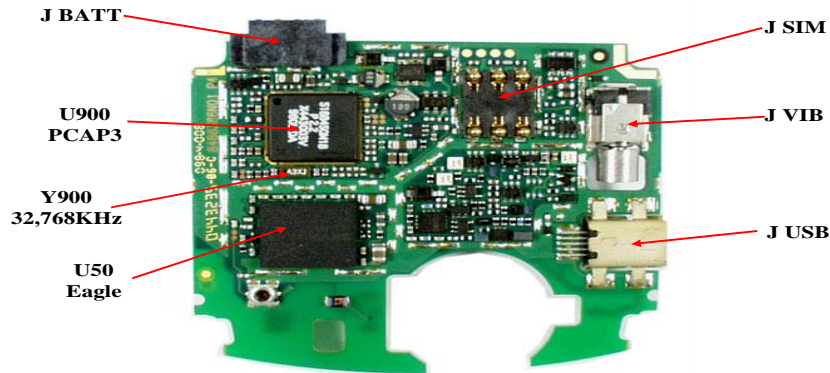

### Bot Side

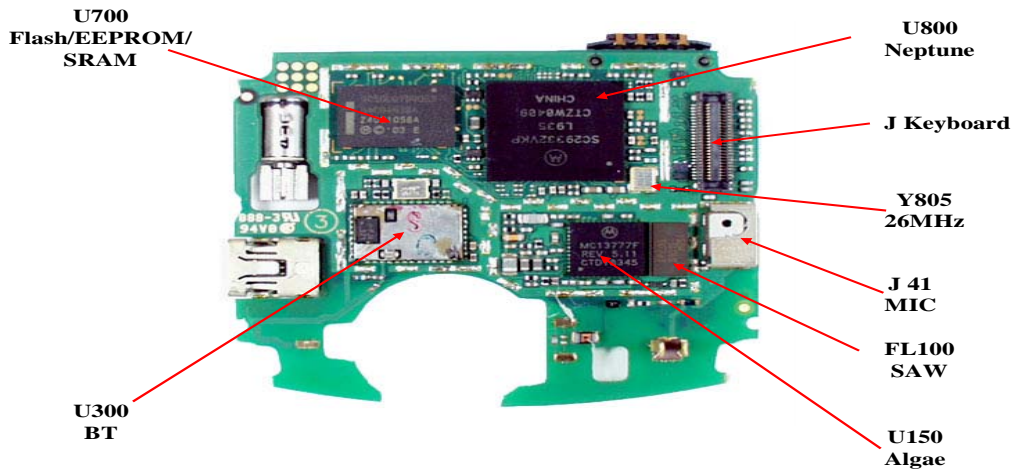

## **Service Website**

Log on to the Motorola service website for more repair information. You will also find **schematic diagram, block diagram**, service bulletins, advisories, software downloads and more for the V3 phone.

The URL for the service website is:

**<https://pcs-service.motorola.com>**

## **Repair Codes**

Repair codes and problem found codes are to be used for all repairs performed on V3 phones. The repair code and the problem found code must be entered on your service link claim or the claim will be rejected. If multiple repairs are performed simultaneously on a particular V3 unit then all associated repair codes and problem found codes must appear on the service link claim.

## **Claimable Parts**

These are the only parts that you will be allowed to claim for repairs on the V3 phone as of the publication of this manual.

<b><u>Part Description</u></b>	<b><u>Part #</u></b>
Keyboard Assembly	8489976N01
Display Assembly	7290086N01
SIM Block / J-SIM Connector	3989888N01

## **MODULE 4**

- **-Test Equipment**
- **- Software**
- **-Accessories**

## Tools and Test Equipment

<u>Part Number</u>	<u>Description</u>	<u>Application</u>
RSX4043	Torque Driver	Used to remove and replace screws
Purchase from local supplier	Torque Driver Bit T-6	Used with torque driver
SPN4716	Rapid Charger	Used to charge battery and to power Device
0180386A82	Antistatic Mat Kit Includes 6680387A95 mat	Provide protection from damage to devices caused by electrostatic discharge
4280385A59	Wrist Band	Provide protection from damage to devices caused by electrostatic discharge
6680388B67	Disassembly plastic Tool	Used during assembly/disassembly
Purchase from local supplier	Tweezers Plastic	Used during assembly/disassembly
Purchase from local supplier	Tweezers stainless	Used during assembly/disassembly
Purchase from local supplier	Wire cutters	Used during assembly/disassembly
Purchase from local supplier	Digital Multi meter	Used to measure voltage/current

## **Software**

### **Current firmware version for the V3:**

Software Version: **R374\_G\_0E.40.7AR**

Flex Version: **GSMV3xxRGR01NA096**

The Software Matrix is available to all ASC's and flash centres on our service website at:

**[pcs-service.motorola.com](http://pcs-service.motorola.com)**

After logging in, go to "Software & Documents", then "Service Software & Documents", then select "Documents" from the list.



## **Accessories**

Battery	
Mid-Rate travel charger	SPN4992
Desktop charger, mallard refresh	SPN5029
Vehicle power adapter	SYN7818
Speakerphone attachment	SPN5028
Headset, FM stereo radio	SYN8609
Headset, dual, retractable	SYN8284
Headset, single, retractable	SYN9050
Headset, send / end button	SYN9351
Headset, over the ear	SYN8908
Headset, silver	AAYN4264
Hands-free (compatible with T-coil hearing aids)	SYN7875
Data kit, USB	S8951
Data kit, serial multi-connect	S8952
Data kit, serial multi-connect for Palm™ III/V	S8953
Data cable, USB	SKN6311
Data cable, serial	SKN6315
Data cable, serial for Palm™ III	SKN6320
Data head, serial	SYN0279