

1

2

3

4

5

MOTOROLA CONFIDENTIAL PROPRIETARY

4 1 3 A

Engineer:
Roman Chudzik
Drawn by:
Roman Chudzik



R&D CHK:

TITLE: keypad_P0
C975
Size: 11x21

DOC CTRL CHK:

MFG CTRL CHK:

QA CHK:

REV: Drawing Number: Page: 1 Of: 1

Changed by:

Date: Friday, January 30, 2004
Time: 5:10:50 pm

A

B

C

D

Engineer:
Roman Chudzik
Drawn by:
Roman Chudzik
R&D CHK:
DOC CTRL CHK:
MFG CTRL CHK:
QA CHK:



TITLE: 8403673B01_P0
C975 keypad board
Size: 11x17

REV: 0 Drawing Number: Page: 1 Of: 1

Changed by: Date: Tuesday, February 3, 2004 Time: 11:39:27 am

TARAZED KEYPAD BOARD

P0_1
Simone Pernice
Copied from Pictor P0_5 keyboard schematics and modified
2/09/2005

1

2

3

4

Keypad Connector

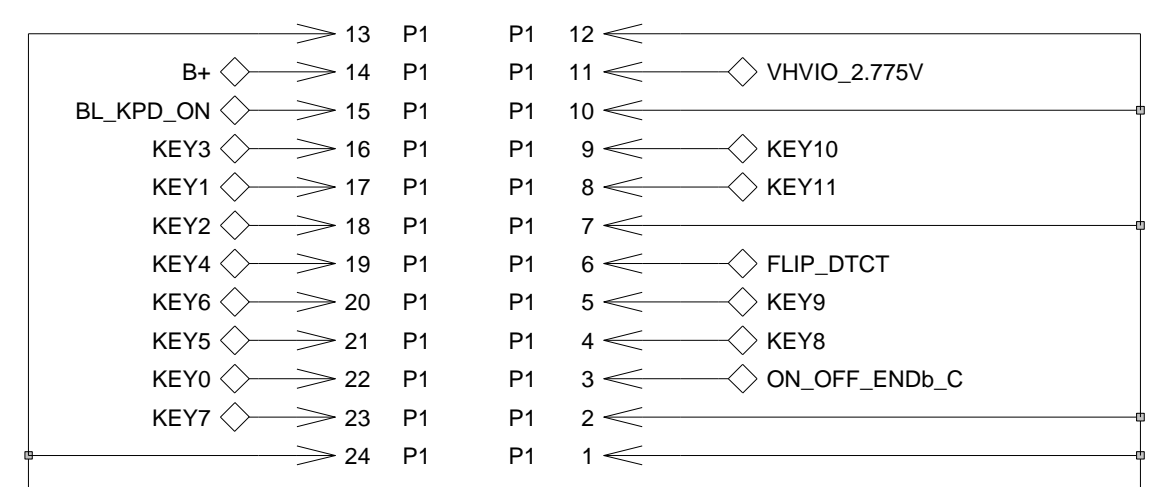

Side Keys Connections

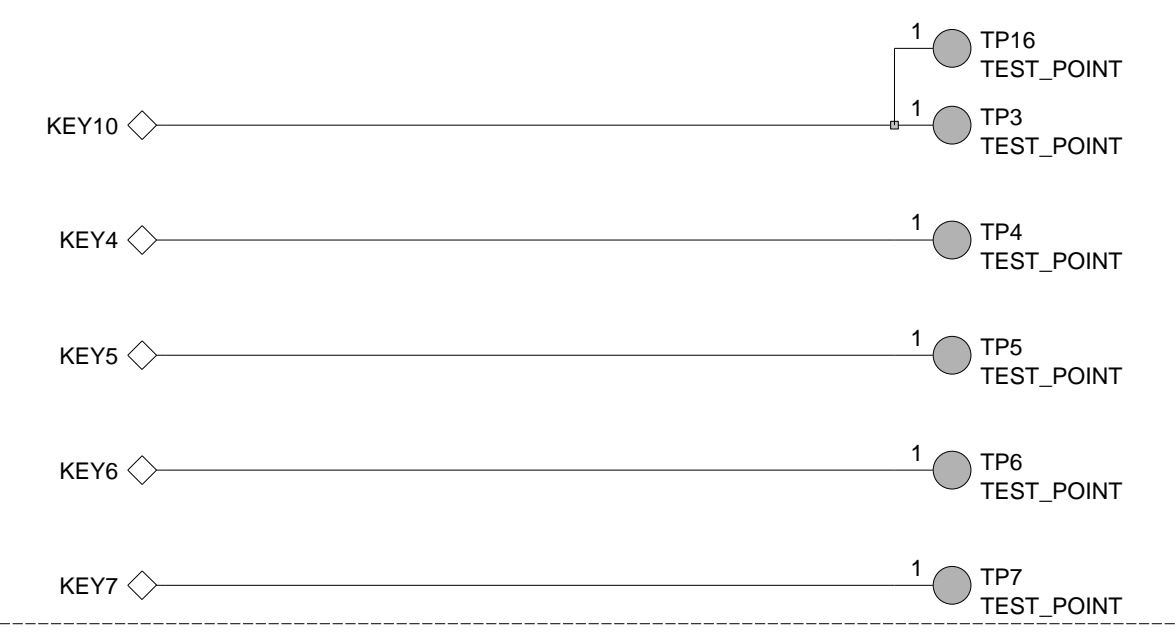

Flip Hall Sensor

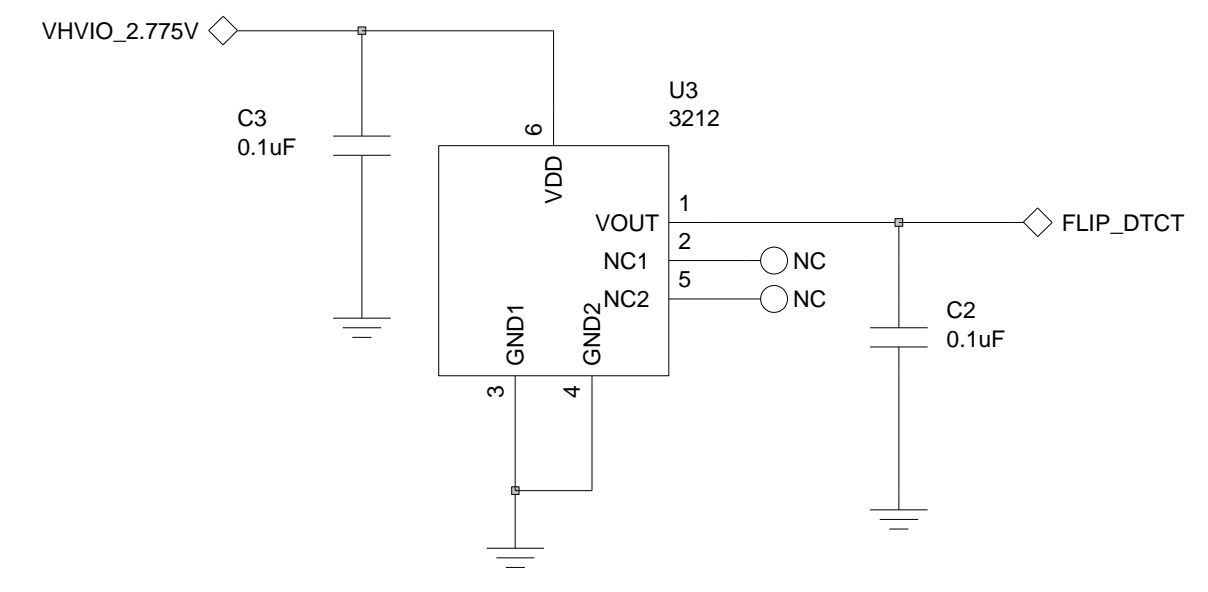

EL Driver

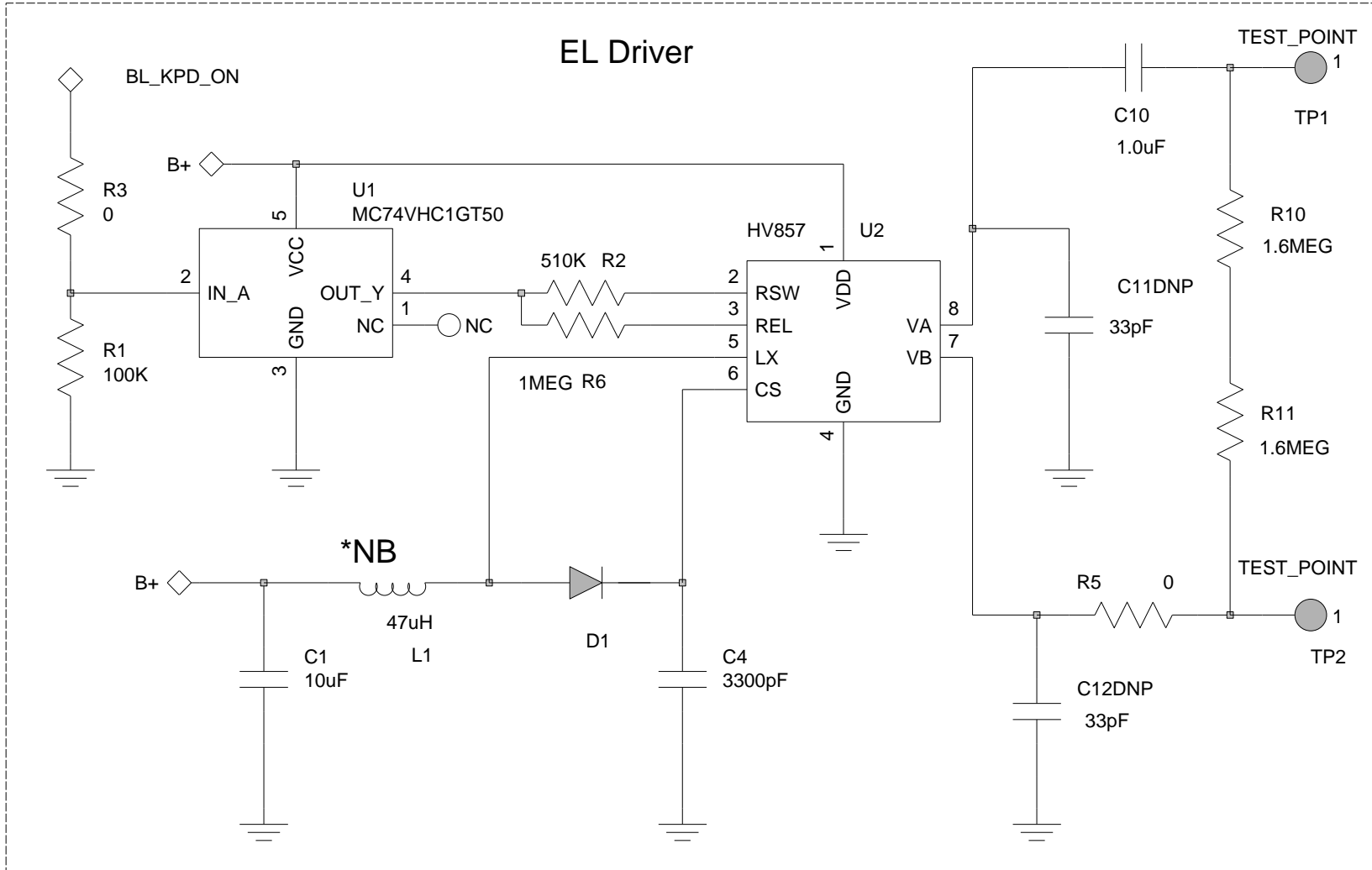

* NB: L1 will be replaced by new part no (220uH, same geometry)

Left Soft

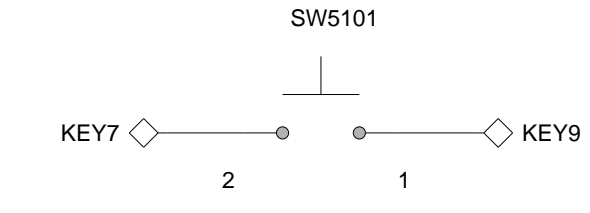

Right Soft

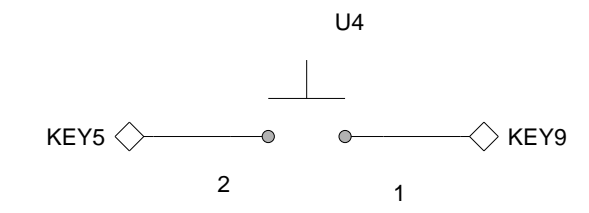

Nav Up

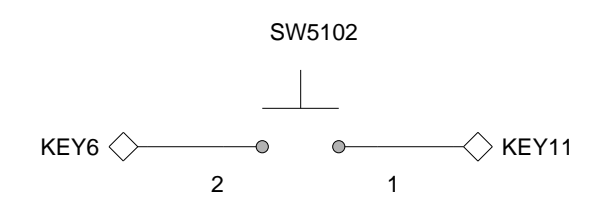

Nav Center

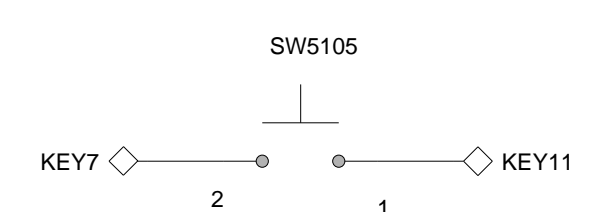

Nav Right

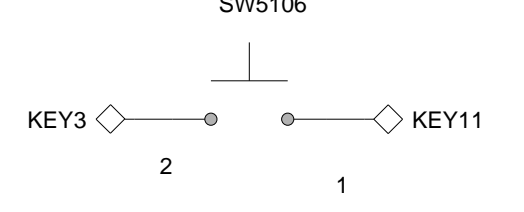

Nav Left

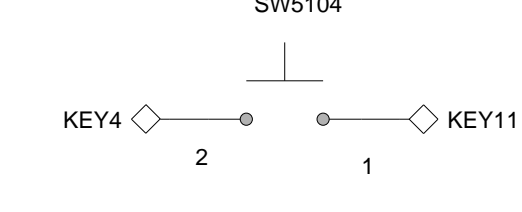

Video Call Send

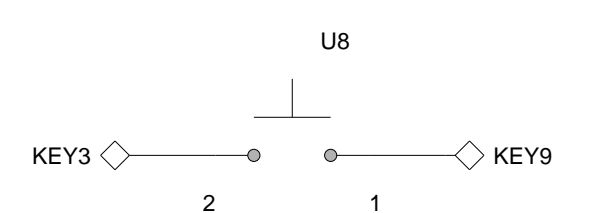

Back Clear

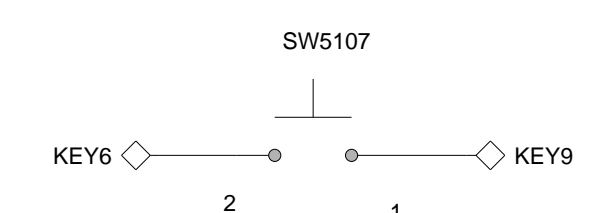

Carrier Browser

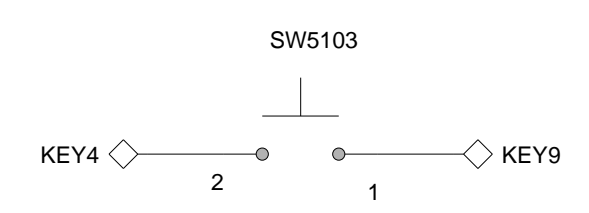

Voice Call Send

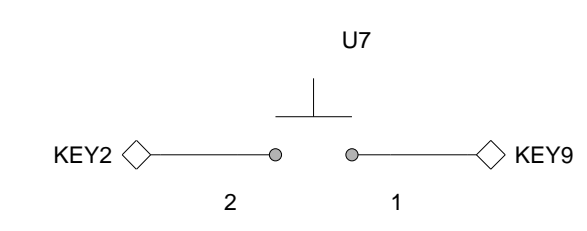

End Call OFF

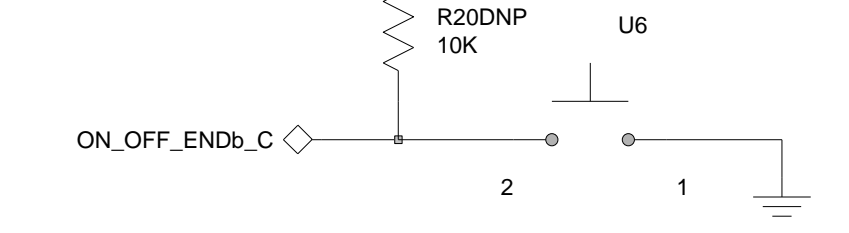

1

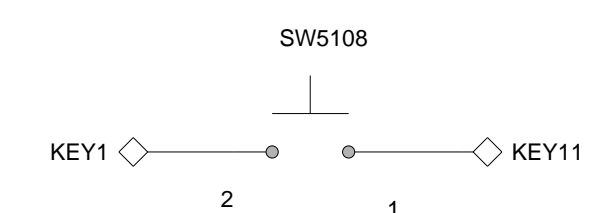

2

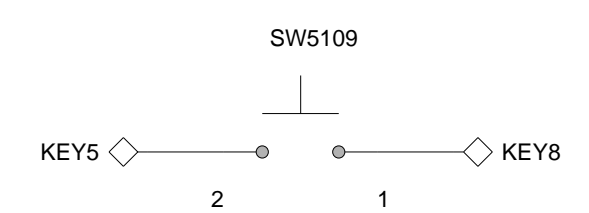

3

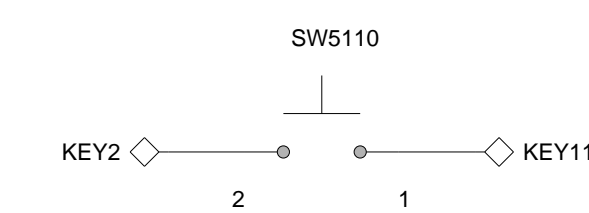

4

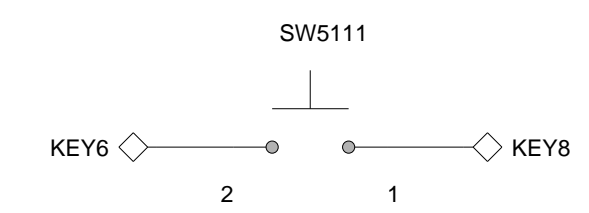

5

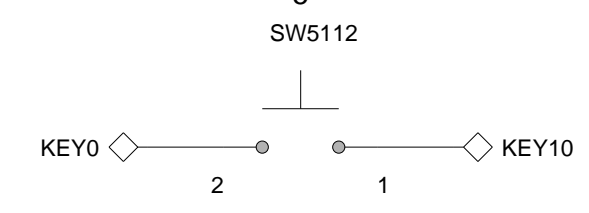

6

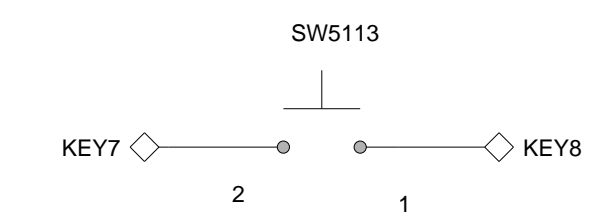

7

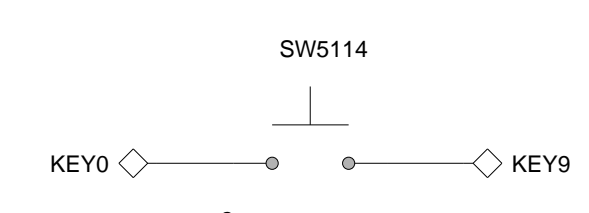

8

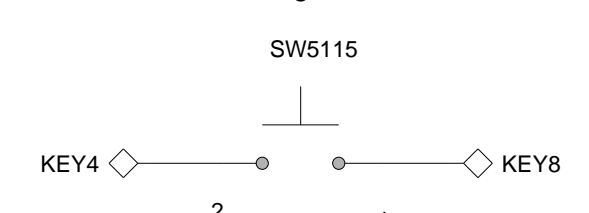

9

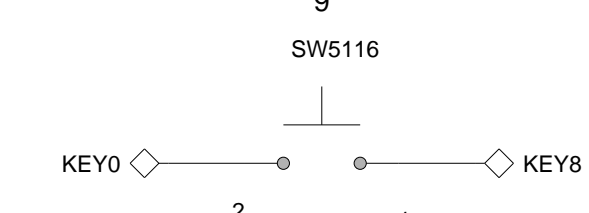

*

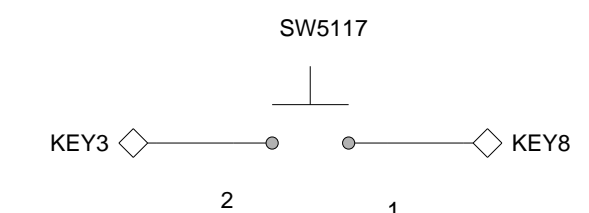

0

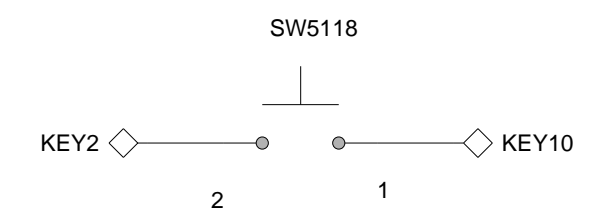

#

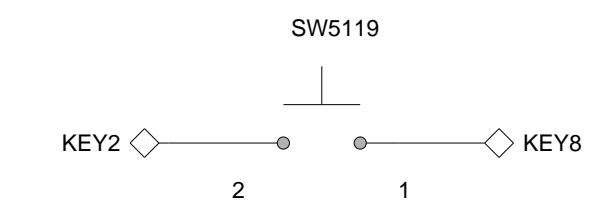

4 GROUND CONNECTIONS

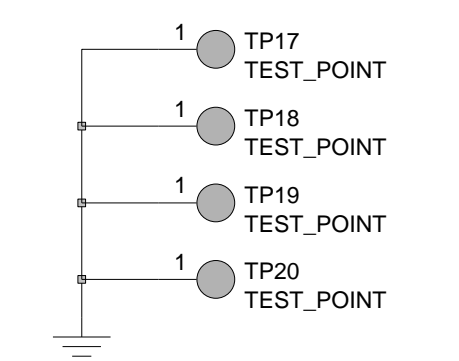

4 ANTENNA CONNECTIONS

