



Level 3 Service Manual

C330 Series Dual Band Wireless Telephone



C330 / C331 / C332 Series
GSM 850/PCS 1900 with GPRS

Table of Contents

Introduction	1
Product Identification	1
Product Names	1
Product Changes	1
Regulatory Agency Compliance	1
Computer Program Copyrights	2
About This Service Manual	2
Warranty Service Policy	3
Parts Replacement	4
Specifications	5
Product Overview	7
Features	7
General Operation	10
Controls, Indicators, and Input / Output (I/O) Connectors	10
User Interface Menu Structure	12
Alert Settings	12
Battery Information	13
Operation	17
Tools and Test Equipment	19
Disassembly	20
Removing and Replacing the Rear Housing Cover	20
Removing and Replacing the Subscriber Identity Module (SIM)	22
Removing and Replacing the Endo Housing	23
Removing and Replacing the Front Endo Housing	24
SIM Holder Removal and Replacement	25
Battery Removal and Replacement	26
Removing and Replacing the Display Assembly	27
Removing and Replacing the Microphone	28
Removing and Replacing the Transceiver Board	29
Removing and Replacing the Rear Speaker	30
Removing and Replacing the Keypad	31
Removing and Replacing the Front Speaker	32
Subscriber Identity Module (SIM) and Identification Label	33
SIM	33
Identification	33
Troubleshooting	35
Manual Test Mode	35
Manual Test Mode Commands	35
Troubleshooting Chart	37
Programming: Software Upgrade and Flexing	38
Part Number Charts	39
Related Publications	39
Exploded View Diagram	40
Exploded View Parts List	41
Model-Specific Part Numbers	42
Accessories	43
Index	Index-1

Introduction

Motorola® Inc. maintains a worldwide organization that is dedicated to provide responsive, full-service customer support. Motorola products are serviced by an international network of company-operated product care centers as well as authorized independent service firms.

Available on a contract basis, Motorola Inc. offers comprehensive maintenance and installation programs which enable customers to meet requirements for reliable, continuous communications.

To learn more about the wide range of Motorola service programs, contact your local Motorola products representative or the nearest Customer Service Manager.

Product Identification

Motorola products are identified by the model number on the housing. Use the entire model number when inquiring about the product. Numbers are also assigned to chassis and kits. Use these numbers when requesting information or ordering replacement parts.

Product Names

Product names included in Product Family 0C35 (C330 Series) telephones are listed on the front cover. Product names are subject to change without notice. Some product names, as well as some frequency bands, are available only in certain markets.

Product Changes

When electrical, mechanical or production changes are incorporated into Motorola products, a revision letter is assigned to the chassis or kit affected, for example; -A, -B, or -C, and so on.

The chassis or kit number, complete with revision number is imprinted during production. The revision letter is an integral part of the chassis or kit number and is also listed on schematic diagrams and printed circuit board layouts.

Regulatory Agency Compliance

This device complies with Part 15 of the FCC Rules. Operation is subject to the following conditions:

1. This device may not cause any harmful interference, and
2. must accept interference received, including interference that may cause undesired operation.

This class B device also complies with all requirements of the Canadian Interference-Causing Equipment Regulations (ICES-003).

Cet appareil numérique de la classe B respecte toutes les exigences du Règlement sur le matériel brouilleur du Canada.

Computer Program Copyrights

The Motorola products described in this manual may include Motorola computer programs stored in semiconductor memories or other media that are copyrighted with all rights reserved worldwide to Motorola. Laws in the United States and other countries preserve for Motorola, Inc. certain exclusive rights to the copyrighted computer programs, including the exclusive right to copy, reproduce, modify, decompile, disassemble, and reverse-engineer the Motorola computer programs in any manner or form without Motorola's prior written consent. Furthermore, the purchase of Motorola products shall not be deemed to grant either directly or by implication, estoppel, or otherwise, any license or rights under the copyrights, patents, or patent applications of Motorola, except for a nonexclusive license to use the Motorola product and the Motorola computer programs with the Motorola product.

About This Service Manual

Using this service manual and the suggestions contained in it assures proper installation, operation, and maintenance of C330 Series telephones. Refer questions about this manual to the nearest Customer Service Manager.

A product family is the group of products having the same Account Product Code (APC). To locate the APC on a device, refer to "Mechanical Serial Number (MSN)" later in this manual.

Audience

This document aids service personnel in testing and repairing C330 Series telephones. Service personnel should be familiar with electronic assembly, testing, and troubleshooting methods, and with the operation and use of associated test equipment.

Use of this document assures proper installation, operation, and maintenance of Motorola products and equipment. It contains all service information required for the equipment described and is current as of the printing date.

Scope

The scope of this document is to provide the reader with basic information relating to C330 Series telephones, and also to provide procedures and processes for repairing the units at Level 1 and 2 service centers including:

- Unit swap out
- Repairing of mechanical faults
- Basic modular troubleshooting
- Testing and verification of unit functionality
- Initiate warranty claims and send faulty modules to Level 3 or 4 repair centers.

Conventions

Special characters and typefaces, listed and described below, are used in this publication to emphasize certain types of information.



Note: Emphasizes additional information pertinent to the subject matter.



Caution: Emphasizes information about actions which may result in equipment damage.



Warning: Emphasizes information about actions which may result in personal injury.



Keys to be pressed are represented graphically. For example, instead of “Press the Enter Key”, you will see “Press ”.

Information from a screen is shown in text as similar as possible to what appears in the display. For example, `ALERTS` or `ALERTS` or `ALERTS`.

Information that you need to type is printed in **boldface type**

Revisions

Any changes that occur after manuals are printed are described in publication revision bulletins (*PMRs*). These bulletins provide change information that can include new parts listing data, schematic diagrams, and printed board layouts.

Warranty Service Policy

The product will be sold with the standard 12 months warranty terms and conditions. Accidental damage, misuse, and extended warranties offered by retailers are not supported under warranty. Non warranty repairs are available at agreed fixed repair prices.

Out of Box Failure Policy

The standard out of box failure criteria applies. Customer units that fail very early on after the date of sale, are to be returned to Manufacturing for root cause analysis, to guard against epidemic criteria. Manufacturing to bear the costs of early life failure.

Product Support

Customer's original units will be repaired but not refurbished as standard. Appointed Motorola Service Hubs will perform warranty and non-warranty field service for level 2 (assemblies) and level 3 (limited PCB component). The Motorola HTC centers will perform level 4 (full component) repairs.

Customer Support

Customer support is available through dedicated Call Centers and in-country help desks. Product Service training should be arranged through the local Motorola Support Center.

Parts Replacement

When ordering replacement parts or equipment, include the Motorola part number and description used in the service manual or supplement.

When ordering crystals or channel elements, specify the Motorola part number, description, crystal frequency, and operating frequency desired.

When the Motorola part number of a component is not known, use the product model number or other related major assembly along with a description of the related major assembly and of the component in question.

In the U.S.A., to contact Motorola, Inc. on your TTY, call: 800-793-7834

Accessories and Aftermarket Division (AAD)

Replacement parts, test equipment, and manuals can be ordered from AAD.

U.S.A.

Phone: 800-422-4210

FAX: 800-622-6210

Outside U.S.A.

Phone: 847-538-8023

FAX: 847-576-3023

To order spare parts in the EMEA region call +44 131 479 1274.

To order spare parts in Asia call +65 648 62995.

Specifications

General Function	Specification
Frequency Range GSM 850	824-848 MHz Tx 869-893 MHz Rx
Frequency Range GSM 900	880-915 MHz Tx (with EGSM) 925-960 MHz Rx
Frequency Range DCS 1800	1710-1785 MHz Tx 1805-1880 MHz Rx
Frequency Range PCS 1900	1850-1910 MHz Tx 1930-1990 MHz Rx
Channel Spacing	200 kHz
Channels	174 EGSM, 374 DCS, 374 PCS, 124 GSM 850 carriers with 8 channels per carrier
Modulation	GMSK at BT = 0.3
Transmitter Phase Accuracy	5 Degrees RMS, 20 Degrees peak
Duplex Spacing	45 MHz GSM, 95 MHz DCS, 80 MHz PCS
Frequency Stability	± 0.10 ppm of the downlink frequency (Rx)
Operating Voltage	+3.0V dc to +4.2V dc (cell) +4.4V dc to +6.6V dc (external charger jack with 2.4 K ohm resistor)
Average Transmit Current	300 mA max
Average Stand-by Current	4.0 mA max (DRX2), 2.0 mA max (DRX9)
Dimensions	130 mm x 46 mm x 24.5 mm (5.1 inches x 1.8 inches x 0.96 inches)
Size (Volume)	105 cc (6.4 in ³)
Weight	106 gm (3.74 oz) with cell
Temperature Range	-10° C to +55° C (+15° F to +130° F)
Battery Life, 600 mAh Li Ion Battery	Talk time up to 300 minutes Standby time up to 300 hours
	All talk and standby times are approximate and depend on network configuration, signal strength, and features selected. Standby times are quoted as a range from DRX=2 to DRX=9. Talk times are quoted as a range from DTX off to DTX on.

Transmitter Specification	
RF Power Output	33 dBm nominal GSM 900 30 dBm nominal GSM 1800 30 dBm nominal PCS
Output Impedance	50 ohms nominal
Spurious Emissions	-36 dBm from 0.1 to 1 GHz, -30 dBm from 1 to 4 GHz

Receiver Specification	
Receive Sensitivity	-106 dBm GSM 900, -104 dBm GSM 1800, -104 dBm PCS
RX bit error rate (100k bits) Type II	< 2%
Channel Hop Time	500 microseconds
Time to Camp	Approximately 5-10 seconds

Speech Coding Function	Specification
Speech Coding Type	Regular pulse excitation / linear predictive coding with long term prediction (RPE LPC with LTP)
Bit Rate	13.0 kbps
Frame Duration	20 ms
Block Length	260 bits
Classes	Class 1 bits = 182 bits; Class 2 bits = 78 bits
Bit Rate with FEC Encoding	22.8 kbps

Product Overview

Motorola PF 0C35 mobile telephones feature global system for mobile communications (GSM) air interface, general packet radio service (GPRS) transport technology, and wireless application protocol (WAP) Internet browser. The mobile telephone uses a simplified icon and graphical-based user interface (UI) for easier operation, allow short message service (SMS) text messaging, and include clock, alarm, datebook, calculator, and caller profiling personal management tools. The PF 0C35 is a dual band phone that allows roaming within the GSM 850, GSM 900 MHz and digital cellular system (DCS) 1800 MHz and 1900 PCS bands.

PF 0C35 telephones support GPRS and SMS in addition to traditional circuit switched transport technologies. GPRS, where available, provides substantial increases in mobile data communications performance and the efficient use of radio spectrum. Data transmission rates for GSM networks can potentially increase from the current rate of 9.6 kbps up to a theoretical maximum of 171.2 kbps. An increased data rate is by no means the only benefit provided by GPRS. A key advantage is the provision of a permanent virtual connection to the network. This “always on” connection is possible because GPRS uses packet data transfer so that, for example, email can be downloaded in “background mode.” There is no need for the user to re-connect before requesting a service, eliminating connection set-up delays and adding convenience and immediacy to data services access. The “virtual” nature of this connection means that network resources are not consumed during periods when a user is not actually sending or receiving data.

The telephones are made of polycarbonate plastic with a metal enclosure. The display and speaker, as well as the 18-key keypad, transceiver printed circuit board (PCB), microphone, charger and headphone connectors, and power button are contained within the candy bar form-factor housing. The 600 mAh Lithium Ion (Li Ion) battery provides more than 300 minutes of talk time with up to 300 hours of standby time¹. The phone accepts 3V mini subscriber identity module (SIM) cards which fit into the SIM holder under the rear housing cover. These telephones feature a 96 x 64 pixel 900 square millimeter high-resolution graphics display and an internal antenna.

Features

PF 0C35 telephones use advanced, self-contained, sealed, custom integrated circuits to perform the complex functions required for GSM GPRS communication. Aside from the space and weight advantage, microcircuits enhance basic reliability, simplify maintenance, and provide a wide variety of operational functions.

Features available in this family of telephones include:

- Lower voltage technology that provides increased standby and talk times
- Extended GSM (EGSM) channels
- Tri-coder/decoder (CODEC) that allows full rate, half rate, and enhanced full rate modes of transmission
- Supports SMS, concatenated SMS, and cell broadcast messages²
- Supports GPRS, circuit switched, and SMS networks²
- WAP 1.2.1 compliant²
- Super enhanced sound engine

1. All talk and standby times are approximate and depend on network configuration, signal strength, and features selected. Standby times are quoted as a range from DRX=2 to DRX=9. Talk times are quoted as a range from DTX off to DTX on.

2. Network, subscription and SIM card or service provider dependent feature. Not available in all areas.

- 96 X 64 pixel grayscale graphical display with 4 lines of text, 1 line of icons, and 1 line of prompts
- Display zoom
- Display animation
- VibraCall® vibrating alert
- 4-Way navigation key
- Downloadable wallpaper and ring tones³
- Voice activation for phone book entries
- Simplified text entry using iTAP™ predictive text entry
- Calling line identification³
- Supports call diverting for incoming voice calls³
- Supports 3V SIM cards
- SIM Toolkit™ Class 2 (STK)³
- Personal management tools calculator with currency converter, real time clock with date, reminders, and caller profiling
- Phase II Unstructured Supplementary Service Data (USSD)³
- Hearing Aid Telephone Interconnection System (HATIS) support
- Chat messaging via WAP over GPRS³
- Multiple destination SMS
- TrueSync™ Multi-Point Synchronization Capability

Speaker Dependant Voice Activation

The voice dialing feature allows the user to recall pre-programmed voice numbers simply by pressing the Voice/Ok key and speaking the desired voice tag. Up to 10 voice tags can be stored.



The user cannot place or receive calls while adding voice tags to the phone's memory.



Because the GSM standard does not provide the option to store voice tags onto the SIM card, voice tags are added to the phone's memory.

Wireless Access Protocol (WAP) 1.2 Compliancy

In the WAP environment, access to the Internet is initiated in wireless markup language (WML), which is derived from hypertext markup language (HTML). The request is passed to a WAP gateway which retrieves the information from the server in standard HTML (subsequently filtered to WML) or directly in WML if available. The information is then passed to the mobile subscriber via the mobile network.

The PF 0C35's microbrowser can be configured for baud, idle timeout, line type, phone number, and connection type.



Bitmap image data will download as text. If the image is larger than the screen, only part of the image will display.

3. Network, subscription and SIM card or service provider dependent feature. Not available in all areas.



If the user receives a call while in browser mode, the browser will pause and allow the user to resume after completing the call.

Simplified Text Entry

iTAP™ predictive text entry. Press a key to generate a character and a dynamic dictionary uses this to build and display a set of word or name options. The iTAP™ feature may not be available on the phone in all languages.

Caller Line Identification

Upon receipt of a call, the calling party's phone number is compared to the phone book. If the number matches a phone book entry, that name will be displayed. If there is no phone book entry, the incoming phone number will be displayed. In the event that no caller identification information is available, an incoming call message is displayed.



User must subscribe to a caller line identification service through their service provider.

SIM Toolkit™ - Class 2

SIM Application Toolkit is a value-added service delivery mechanism that allows GSM operators to customize the services they offer their customers, from the occasional user who requests sports news and traffic alerts, to a high call time business user who receives stock alerts and checks flight times. Operators can now create their own value-added services menu quickly and easily in the phone. The customized menu will appear as the first menu and may be updated over-the-air with new services when customers request them.

Network Based Chat Messaging

The chat messaging feature provides a constant WAP connection through GPRS to carrier, service center, or factory flexed WAP site. The specific site can also be entered by the user. Chat messaging is a carrier option.

Personal Information Management

The PF0C35 telephone contains a built in calendar with date book reminders and phonebook that can be synchronized easily to a computer or PDA.

General Operation

Controls, Indicators, and Input / Output (I/O) Connectors

The PF 0C35 telephones' controls are located on the front of the device, and on the keyboard as shown in Figure 1. Indicators, in the form of icons, are displayed on the LCD (see Figure 2).

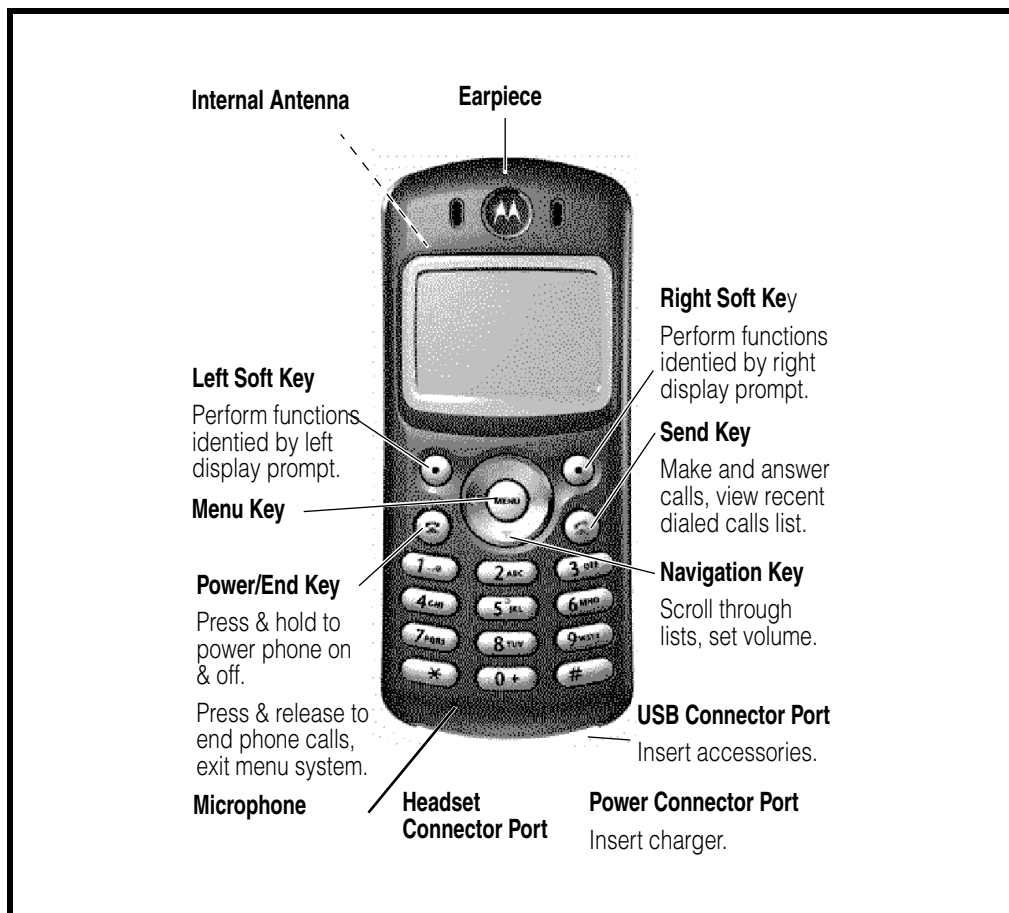

0201570

Figure 1. PF 0C35 Telephone Controls and Indicators Locations

Menu Navigation

PF 0C35 telephones are equipped with a simplified icon and graphical-based user interface. The phone also features a user-definable Quick Access menu that is accessed by holding down the MENU key. See Figure 3 for details of the PF 0C35 menu structure. A 4-way navigation key allows you to move easily through menus.

Liquid Crystal Display (LCD)

The LCD provides an 900 square millimeter white color backlit grayscale display with user-adjustable contrast settings for optimum readability in all light

conditions. The large bit-mapped 96 x 64 pixel display includes up to 4 lines of text, 1 line of icons, and 1 line of prompts.

Display animation makes the phone's icon menu move smoothly as the user scrolls up and down.



Whether a phone displays all indicators depends on the programming and services to which the user subscribes.

Figure 2 shows some common icons displayed on the LCD.

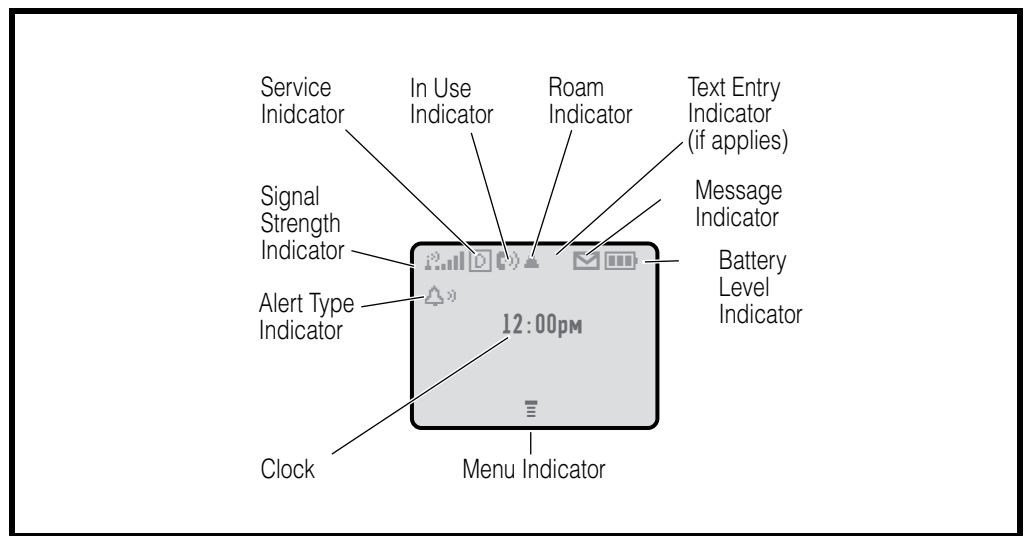

020158o

Figure 2. PF 0C35 Display Icon Indicators

1. **Signal Strength** shows the strength of the phone's connection with the network. Calls cannot be sent or received when the "no signal" indicator is displayed.
2. **In Use Indicator** icon indicates a call in progress.
3. **Roam Indicator** icon appears when the phone uses another network system outside the user's home network. When leaving the home network area, the phone roams, or seeks, another network.
4. **Message Waiting Indicator**⁴ appears when the phone receives a text message.
5. **Voice Message Waiting Indicator**⁴ icon indicates when the phone receives a voicemail message.
6. **Battery Level Indicator** shows the amount of charge left in the battery.
7. **Real Time Clock** shows the current time.
8. **Menu Indicator** provides access to the phone's main menu.
9. **GPRS Indicator**⁴ indicates when the phone is currently functioning in GPRS mode.
10. **Alert Setting Indicator** indicates the phones current ringer alert setting.

4. Network, subscription and SIM card or service provider dependent feature. Not available in all areas.

User Interface Menu Structure

Figure 3 shows the PF 0C35 telephone menu structure.

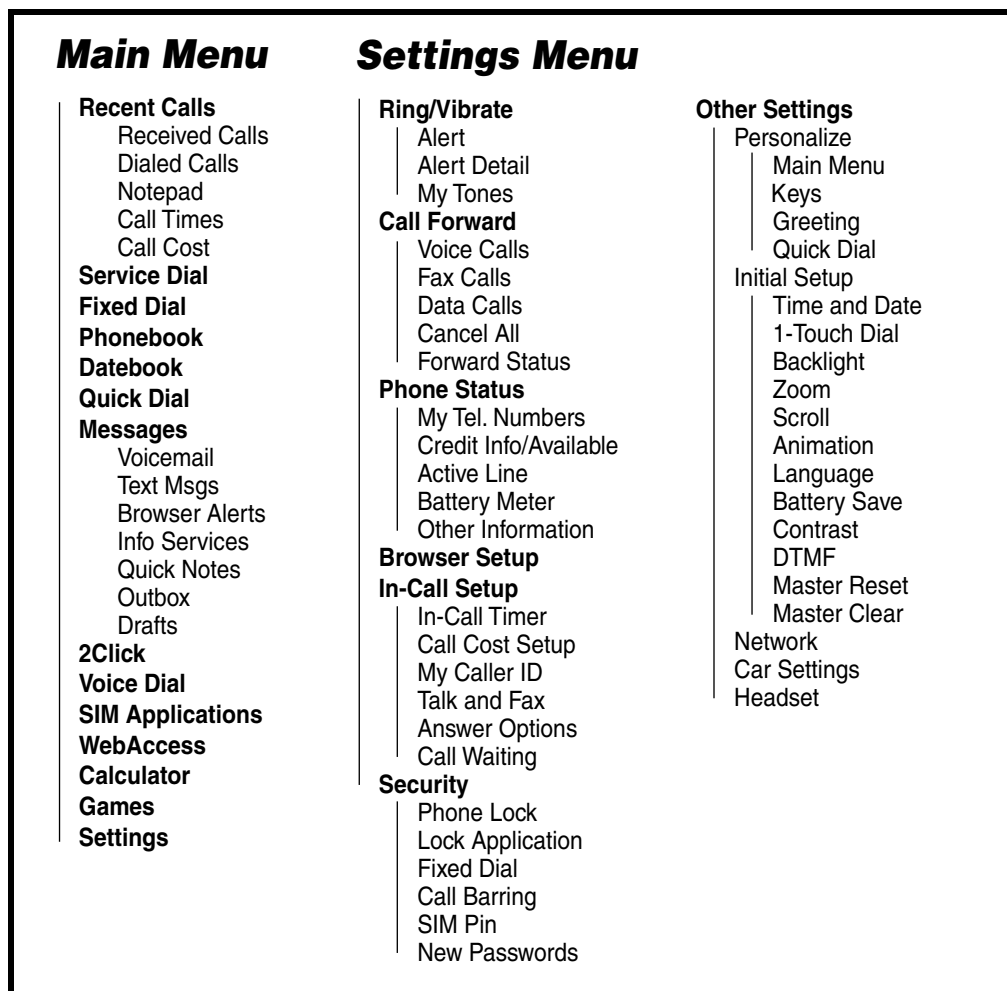

0201590

Figure 3. PF 0C35 Menu Structure

Alert Settings

In addition to preset ring tones, PF 0C35 telephones allow the user to download additional ring tones via SMS to your PC. (Availability is carrier and Network dependant).

Motorola PF 0C35 phones incorporate the VibraCall® discreet vibrating alert that helps to avoid disturbing others when a ringing phone is unacceptable.

Alerts can be set to ring only, vibrate only, vibrate then ring, or no ring or vibrate

Additionally, the profiling feature allows users to identify incoming calls by a specific ringer tone.

Battery Information

Battery Charge Indicator

The telephone displays a battery charge indicator icon in the idle screen to indicate the battery charge level. The gauge shows four levels: 100%, 66%, 33%, and Low Battery.

Embedded Battery Removal

Removing the battery causes the device to immediately shut down and any pending work (partially entered phone book entries or outgoing messages, for example) is lost.



All batteries can cause property damage and / or bodily injury such as burns if a conductive material such as jewelry, keys, or beaded chains touch exposed terminals. The conductive material may complete an electrical circuit (short circuit) and become quite hot. Exercise care in handling any charged battery, particularly when placing it inside a pocket, purse, or other container with metal objects.



If the battery is removed while receiving a message, the message will be lost.



To ensure proper memory retention, turn the phone OFF before removing the battery. Immediately replace the old battery with a fresh battery.



Ensure battery switch is always in the ON position.

Battery Date Code

The battery date code is a 15 position alphanumeric code that provides, back end manufacture site information, year and week of manufacture date, cell type and vendor information.

The battery date code is used for cell phone batteries that were manufactured beginning in March 2000. The following paragraphs provide more detail about the battery date code.

1. Backend Pack Manufacturing Site (first position of battery code)

A = Motorola Penang	J= ESG, Chihuahua	S = T.D.I Scotland
B = T.D.I. Mexico	K= T.D.I. Romeoville	T = T.D.I Downers Grove
C = Motorola China	L = Motorola Lawrenceville	U = T.D.I. Hungary
D = T.D.I. Shanghai, China	M = TDI, Malaysia	V =
E = ESG, Evadin, Brazil	N = TDI, Manau, Brazil	W = ESG, Sung Woo
F = ESG, Propower, Korea	O =	X = ESG, Foxlink, China
G =	P = Intesys Arizona	Y = P&K (G.E.T.) Systems, Korea
H = Motorola Harvard	Q =	Z =
I = Motorola Ireland	R =	

2. Cell code and vendor (second and third position of battery code): 2 alpha characters.

Cell Reference Designator	Vendor	Size	Part Number
IA	A&TB	6.6x30x48	LGQ633048C
1B	A&TB	6.6x30x48	LGQ633048D
1C	A&TB	6.6x30x47.2	LGQ633048P
1D	A&TB	8.8x34x48	LGQ863448C
1E	A&TB	8.8x34x47.3	LGQ8634481-1
1F	A&TB	18x65	LGR18650E
IG	A&TB	7.5x14.5x48	TH750F5
1H	A&TB	10.5x43.6	TH550AAA
3F	Toshiba	7.5x14.5x48	TH900F5
3G	Gold Peak	1/3A	GPZSAFK

Cell Reference Designator	Vendor	Size	Part Number
3H	Toshiba	4.4x34x56	LA8423456A
3J	Saft	AA	VHAA1200
3K	Maxell	5.5x30x48	ICP053048G
3L	NEC-Moli	6.7x30x47.3	MK11-2293
3M	Mitsubishi	4.4x34x56	Lipmo001
3N	Toshiba	6.6x34x50	LGQ633450R
3P	Panasonic	6x34x50	CGP34506
3R	Toshiba	3.9x34x56	LAB363456A
3S	NEC-Moli	6.5x22x65	MK11-2300
3T	BYD	6.6*9.8x47.9	LP063048A
3U*	Panasonic	LL-AAAA	HHR70QAB4
3V	Sanyo (Toshiba)	6mm NiMH	THF6M
3W	LG Chemical	6x30x48	ICP633048
3X	BYD	5.4x30.1x48.2	LP053048A
3Y	BYD	6x34x50	LPO53048A
3Z*	Panasonic	6.2x35.2x16.	HF6OSS
4A	Peacebay- Manual	6mm NiMH	F6MG
4B	BYD	4x30x48	F6MG
4C	Peacebay-Auto	6.4x16.34	F6MP
4D	Sanyo	6mm NiMH	HFC1U
4E	BYD	8x3 x47.5	LP083448SH
4F	Sony	34x67	UP423467A4H
4G	LG Chemical	8.6x34x48	ICP863448
4H	LG Chemical	6.3x 34x50	ICP633450
4J*	BYD	4x30x41	LP043041A
4K	GS Melcotec	4.6x29.5x41	LP423041A
4L	LG Chemical	4.2x30x48	ICP423048
4M	Toshiba	5.5x30x48	LGQ553048U
4N	Sanyo	3.8x34x50	UF383450P
4P	Toshiba	4.4x34x50	LGQ443450U

Cell Reference Designator	Vendor	Size	Part Number
4R	Toshiba	4.4x30x48	LGQ443048U
4S	Lishen	06x30x48	LP0601AE
4T	Panasonic	AAAALL	HHR70QAB4

3. Cell date code (fourth fifth and sixth position of battery code) consisting of characters as stated on cell pack by cell manufacturer. If a 3 digit code is not used, place a period in the sixth position.
4. Line and shift manufactured (optional) (seventh and eighth positions of battery code)
5. Year of battery manufacture (ninth position of battery code)

1990 = A	1997 = H	2004 = O	2011 = V
1991 = B	1998 = I	2005 = P	2012 = W
1992 = C	1999 = J	2006 = Q	2013 = X
1993 = D	2000 = K	2007 = R	2014 = Y
1994 = E	2001 = L	2008 = S	2015 = Z
1995 = F	2002 = M	2009 = T	
1996 = G	2003 = N	2010 = U	

6. Week of manufacture (tenth and eleventh positions of battery code).

A=0	C=2	E=4	G=6	I=8
B=1	D=3	F=5	H=7	J=9

7. Front end corepack manufacturing site (twelfth position of battery code (see step 1)).

Example of a battery date code: **A1V90311JCCC...**

position 1 = A = Motorola Penang.t (Backend Pack)
 position 2 & 3 = 1V = Panasonic, AAA, HHR55B2
 position 4, 5 & 6 = 903 = cell date code (from manufacturer)
 position 7 & 8 = 11 = (TBD by supplier.Example: Line one of the first shift.)
 position 9 = J = 1999 = Year of battery pack manufacture
 position 10 & 11 = CC = week twenty two. (backend pack)
 position 12 = C = Motorola, China. (Frontend Core Pack)
 position 13, 14 & 15 = placeholders (...) to indicate pack has not been relabeled.

8. Batteries sold in China have a 16 character date code:

Example: **YYYYMMDDABCXXXX**

Where YYYYMMDD is the actual battery manufacturing date

A is the line number

B is the shift number (A,C is day shift; B, D is night shift)

C is a serial number from A to Z

XXXX is a sequence number

9. Embedded battery packs use a 6 character date code:

Position 1 is the manufacturing site:

Manufacturing Site	Code
BYD	a
ESG	b
GSMT China	c
GSMT Japan	d
LG China	e
LG Japan	f
Maxell China	g
Maxell Japan	h
TDI	i
Toshiba China	j
Toshiba Japan	k

Position 2 and 3 is cell code and vendor. See step 2.

Position 4, 5, and 6 is cell date code (year and week). See steps 5 and 6.

Operation

For detailed operating instructions, refer to the appropriate User Guide listed in the Related Publications section toward the end of this manual.



Ensure battery switch is always in the ON position.

Tools and Test Equipment

Table 1 list the tools and test equipment used on PF 0C35 telephones. Use either the listed items or equivalents.

Table 1. General Test Equipment and Tools

Motorola Part Number ¹	Description	Application
See Table 6	Charger	Used to charge battery and to power phone
0180386A82	Antistatic Mat Kit (includes 66-80387A95 antistatic mat, 66-80334B36 ground cord, and 42-80385A59 wrist band)	Provides protection from damage to phone caused by electrostatic discharge (ESD)
8102430Z04	GSM / DCS / PCS Test SIM	Used to enable manual test mode
6680388B67	Disassembly tool, plastic with flat and pointed ends (manual opening tool)	Used during assembly/disassembly of phone
6680388B01	Tweezers, plastic	Used during assembly/disassembly
RSX4043-A	Torque Driver	Used to remove and replace screws
—	Torque Driver Bit T-6 Plus, Apex 440-6IP Torx Plus or equivalent	Used with torque driver
HP34401A ²	Digital Multimeter	Used to measure battery voltage

1. To order in North America, contact Motorola Aftermarket and Accessories Division (AAD) by phone at (800) 422-4210 or FAX (800) 622-6210; Internationally, AAD can be reached by calling (847) 538-8023 or faxing (847) 576-3023.

2. Not available from Motorola. To order, contact Hewlett Packard at (800) 452-4844.

Disassembly

This section describes how to disassemble a PF 0C35 telephone. Tools and equipment used are listed in Table 1, preceding.



Many of the integrated devices used in this equipment are vulnerable to damage from electrostatic discharge (ESD). Ensure adequate static protection is in place when handling, shipping, and servicing the internal components of this equipment.



Avoid stressing the plastic in any way to avoid damage to either the plastic or internal components.

Removing and Replacing the Rear Housing Cover

1. Ensure the phone is turned off.
2. Press down on the rear housing cover latch on the top end of the phone, gently lift the rear housing cover away from the latch and slide the rear housing cover in the direction of the arrow, and lift the cover away from the phone (see Figure 4).

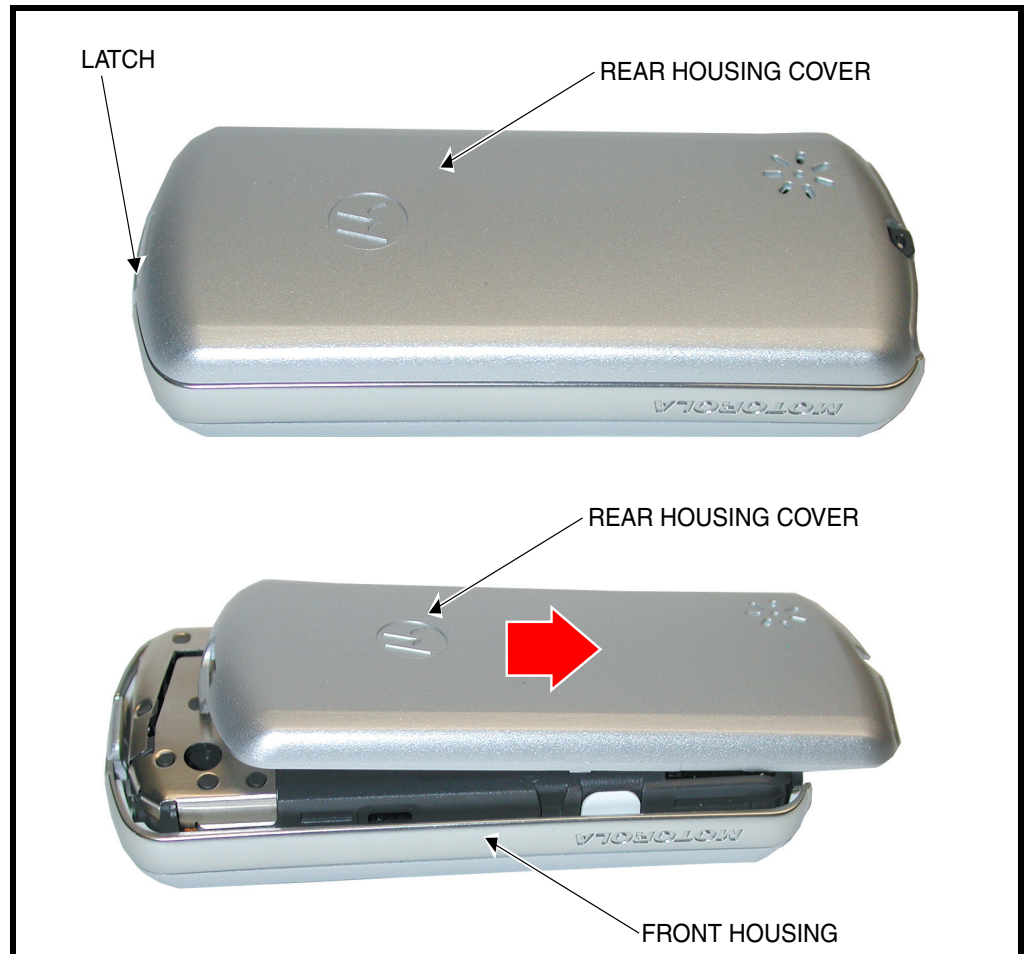

020187o

Figure 4. Removing the Rear housing Cover

3. To replace, align the rear housing cover to the front housing
4. Gently press the rear housing cover into position onto the front housing until the rear housing cover snaps into place.

Removing and Replacing the Subscriber Identity Module (SIM)

1. Remove the rear housing cover as described in the procedures.
2. Lift the metal SIM holder as indicated in Figure 5 to release the SIM.
3. Remove the SIM by sliding it in the direction of the arrow as shown in Figure 5.

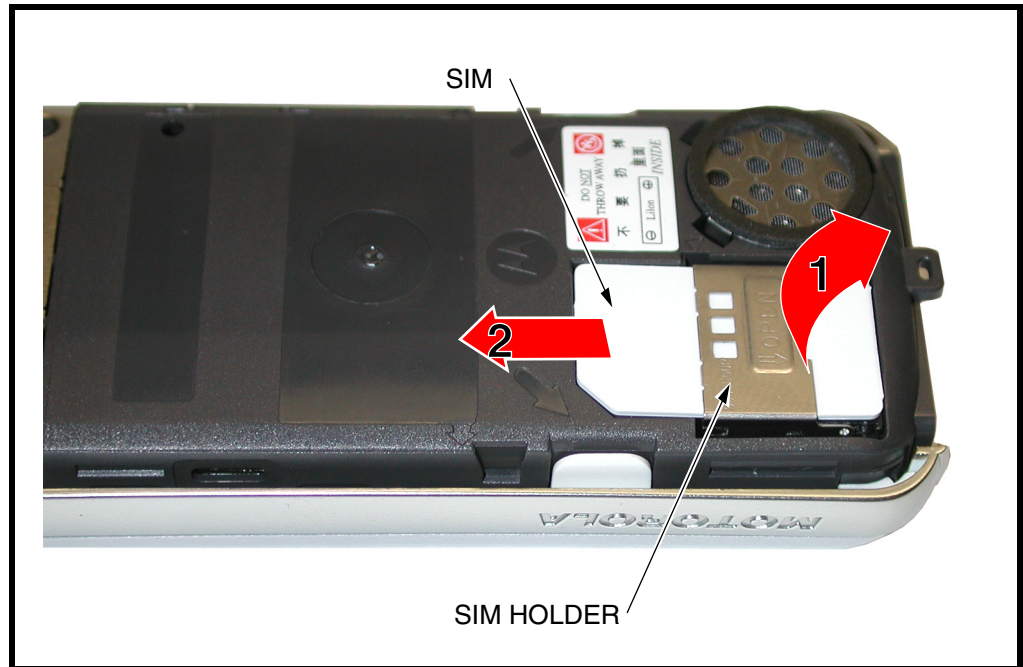

Figure 5. Removing the SIM

4. To replace, carefully slide the SIM into position in its socket.
5. Lower the SIM holder into position over the SIM in the phone.
6. Replace the rear housing cover as described in the procedures.

Removing and Replacing the Endo Housing



Other C330 series phone housings appear differently. The endo housing removal procedure is essentially the same for each type of housing.

1. Remove the rear housing cover, and SIM as described in the procedures.
2. Insert the plastic disassembly tool between the front housing and the endo housing to release the endo housing catches along the sides of the front housing as shown in Figure 6.
3. Lift the endo housing out of the front housing.

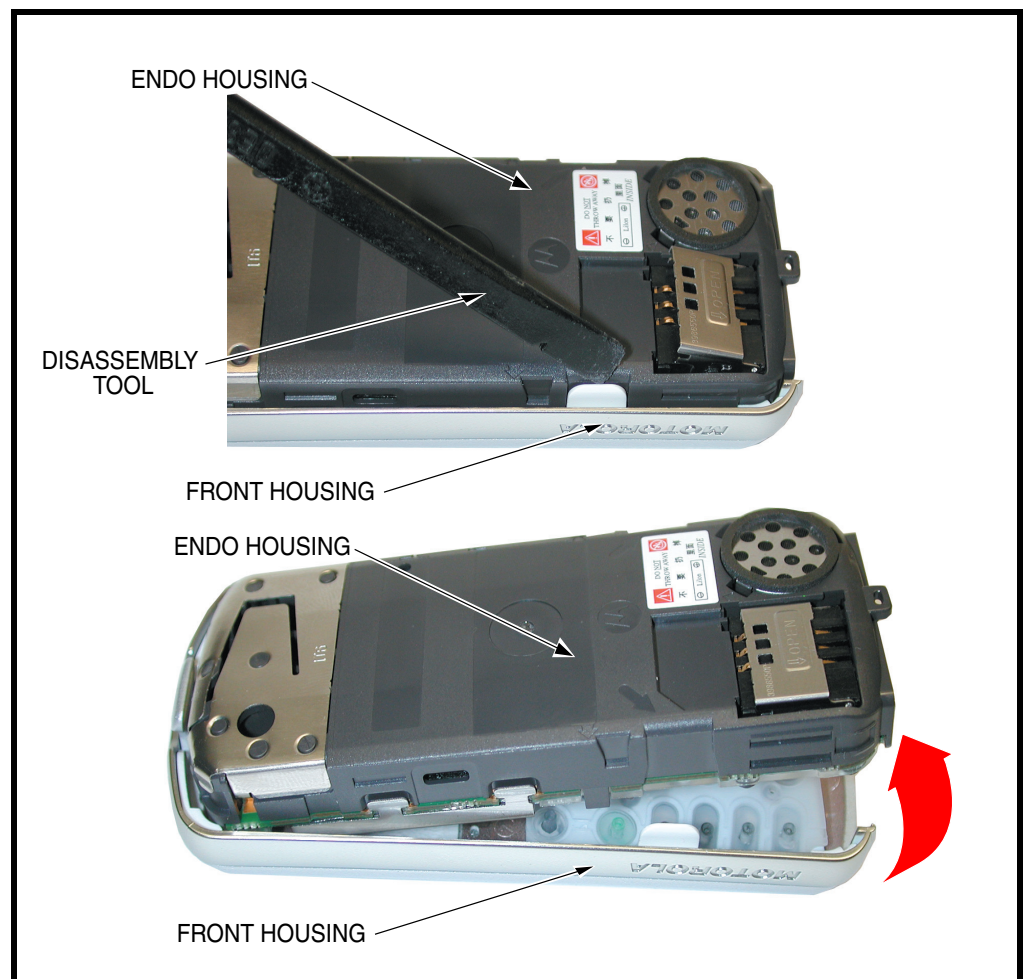
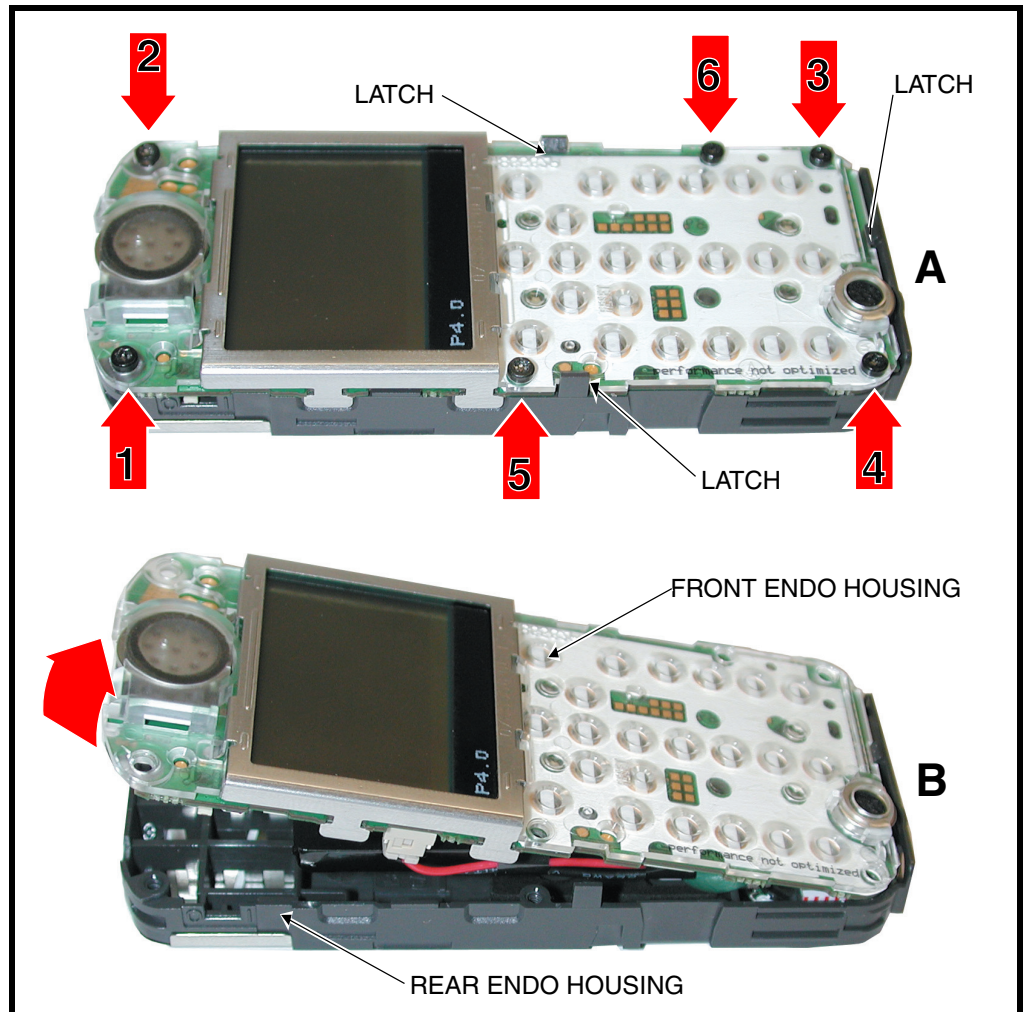

Figure 6. Removing the Endo Housing

4. To replace, align the endo housing with the front housing.
5. Carefully and gently lower the endo housing into the front housing until the catches along the sides of the front housing snap into position.

Removing and Replacing the Front Endo Housing

1. Remove the rear housing cover, SIM, endo housing as described in the procedures.
2. Using the Torx driver and a T-6 bit, remove the 6 screws shown in Figure 7A. Set the screws aside for reuse.
3. Using the disassembly tool, release the latches along the two sides and on the end of the phone as shown in Figure 7A
4. Carefully separate the rear endo housing from the front endo housing.



0201920

Figure 7. Removing the Front Endo Housing

5. To replace, align the front endo housing to the rear endo housing.
6. Carefully and gently press the front and rear endo housing together until the two parts snap into position.
7. Insert and tighten the 6 screws in the sequence indicated by the arrows in Figure 7A to a torque setting of 2.0 kgf. Do not overtighten.
8. Replace the SIM, and front and rear housing covers as described in the procedures.

SIM Holder Removal and Replacement

1. Remove the rear housing cover and SIM as described in the procedures.
2. Turn the endo housing over so the antenna and SIM holder are facing up.
3. Gently press down on the SIM holder.
The SIM holder should easily snap out of the endo housing.

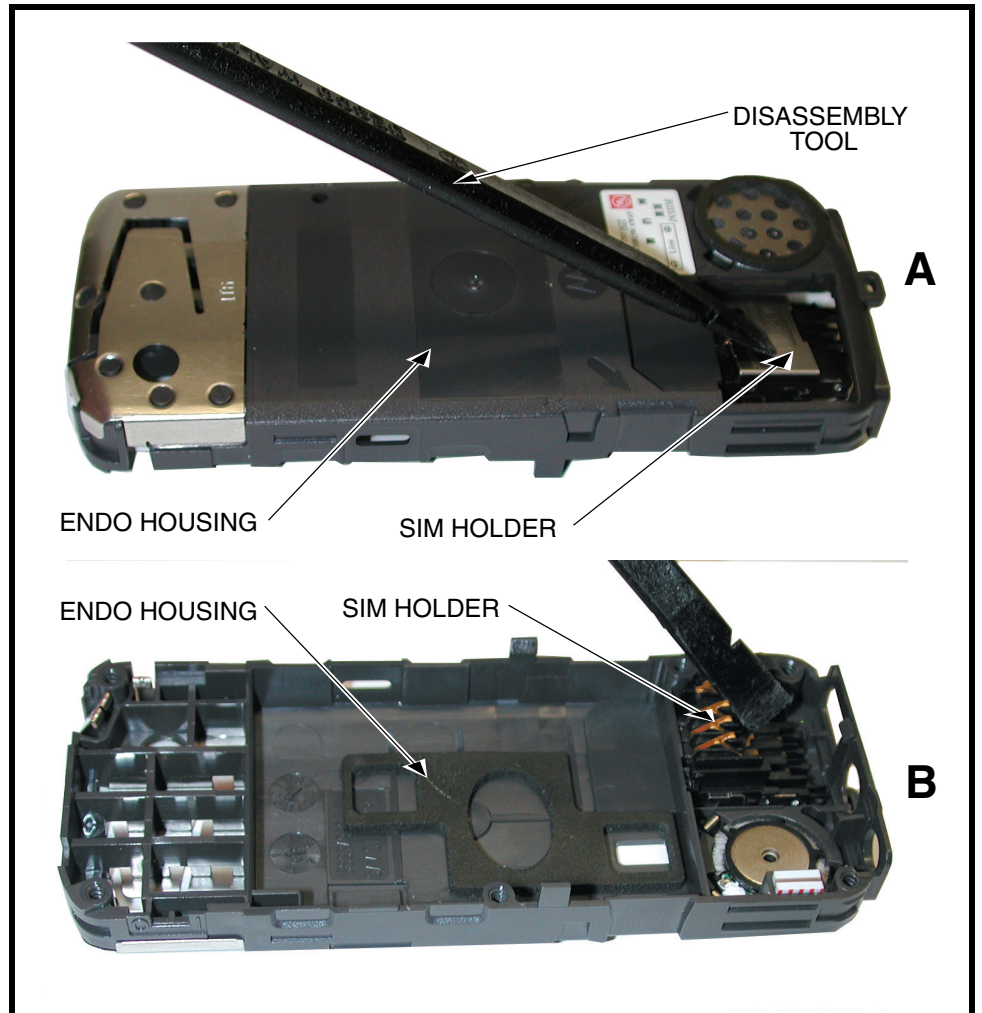

020554

Figure 8. SIM Holder Removal and Replacement

4. To replace, turn the endo housing over so that the interior of the housing is facing up.
5. Insert the SIM holder into the endo housing with the circuit board contacts facing up and the SIM contacts facing down.
6. Gently press the SIM holder until it snaps into position in the endo housing.
7. Replace the SIM and rear housing cover as described in the procedures.

Battery Removal and Replacement

Battery date codes are explained in the Battery Date Code section on page 14. Before handling the battery, please observe the battery cautions listed below.



Do not handle batteries with wet or sweaty hands.

Do not short the positive or negative terminals

Non conductive tweezers or grasping tools are to be used for battery connector manipulation, assembly, and disassembly.

1. Remove the rear housing, SIM, endo assembly, and front endo housing as described in the procedures.
2. Disconnect the battery connector from the connector socket as shown in Figure 9.
3. Hold the battery by its case and remove it from the transceiver board. Do not pull on the battery wires as they may become disconnected from the battery pack or the battery connector.

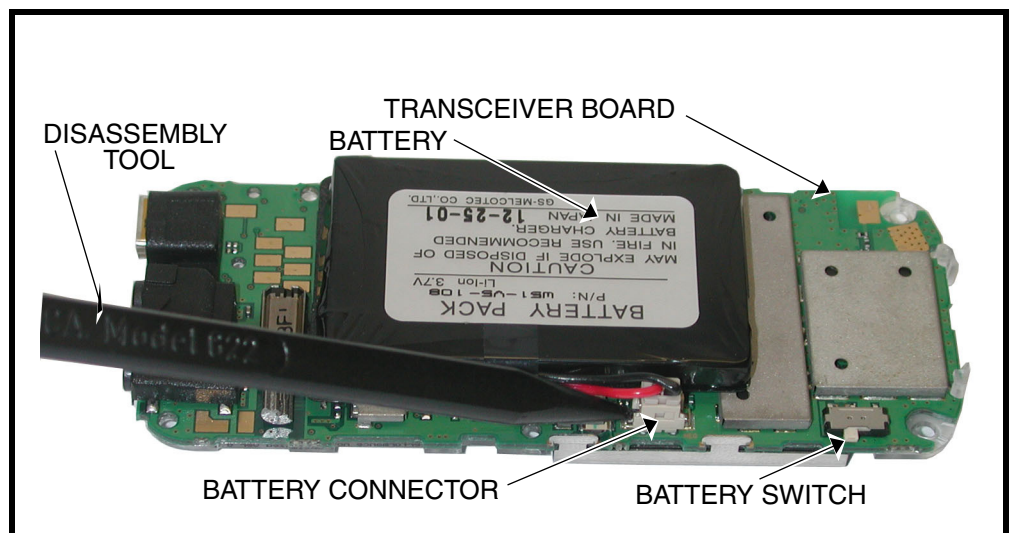

0201930

Figure 9. Removing and Replacing the Battery



There is a danger of explosion if the Lithium ion battery is replaced incorrectly. Replace only with the same type of battery or equivalent as recommended by the battery manufacturer. Dispose of used batteries according to the manufacturer's instructions.

4. To replace, align the battery connector cable with the battery connector socket. The connector and socket are designed to maintain the correct polarity.
5. Replace the front endo housing, endo assembly, SIM, and rear housing as described in the procedures.

Removing and Replacing the Display Assembly

1. Remove the rear housing cover, SIM, endo assembly, front endo housing, and battery, as described in the procedures.
2. Use the disassembly tool to carefully release the 4 metal display latches on each side of the display assembly as shown in Figure 10.
3. Carefully lift the display assembly away from the transceiver board as shown in Figure 10.

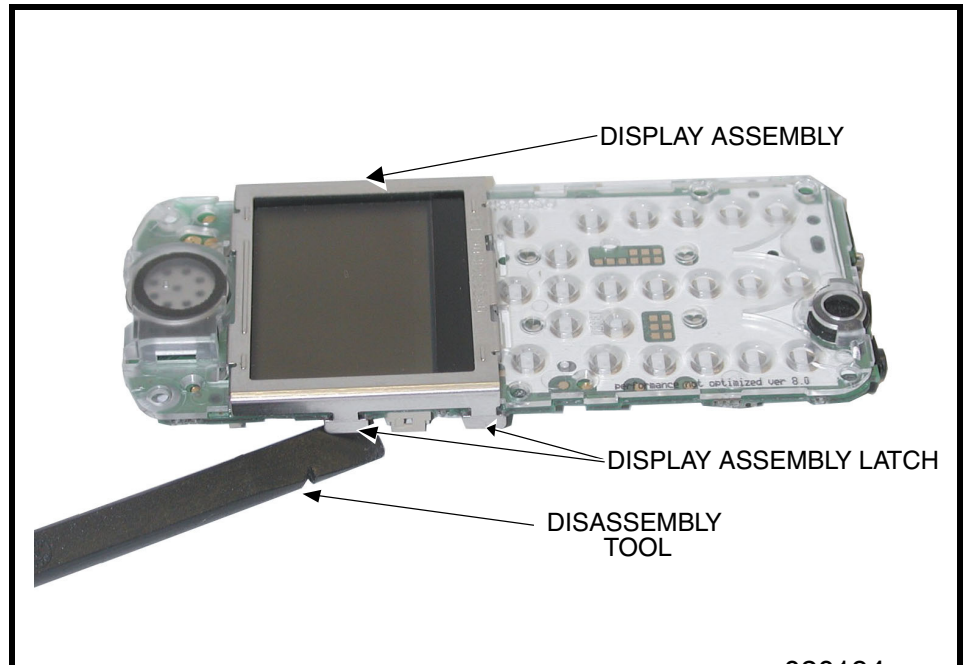

Figure 10. Removing the Display Assembly

4. To replace, align the display assembly with the printed circuit board.
5. Gently press the display assembly latches into position while holding the display assembly in position.
6. Replace the battery, front endo housing, endo assembly, SIM, rear housing cover as described in the procedures.

Removing and Replacing the Microphone

1. Remove the rear housing cover, SIM, endo assembly, front endo assembly, and display assembly as described in the procedures.
2. Turn the display assembly over to reveal the microphone.
3. Use the disassembly tool to gently pry the microphone out of its socket, as shown in Figure 11.
4. Use the plastic tweezers, carefully lift the microphone up and away from the display assembly board.

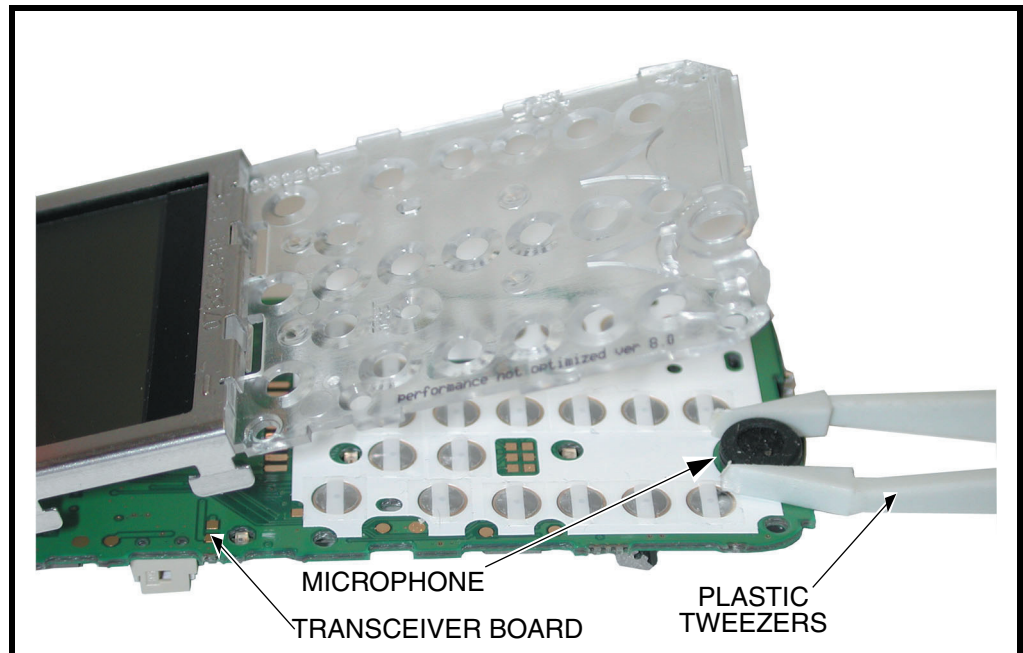

Figure 11. Removing the Microphone

5. To replace, use the plastic tweezers to place the microphone into its socket on the plastic section that holds the display assembly. Ensure the microphone elastomer faces the circuit board contacts when reattaching the printed circuit board.
6. Replace the display assembly, endo front housing, antenna, endo assembly, SIM, and rear housing cover as described in the procedures.

Removing and Replacing the Transceiver Board

1. Remove the rear housing cover, SIM, endo assembly, antenna, front endo housing, display assembly and battery, as described in the procedures.



This product contains static-sensitive devices. Use anti-static handling procedures to prevent electrostatic discharge (ESD) and component damage.

2. Use the disassembly tool to release the display assembly latches that secure the display assembly to the transceiver board.
3. Lift the transceiver board away from the display assembly as shown in Figure 12.

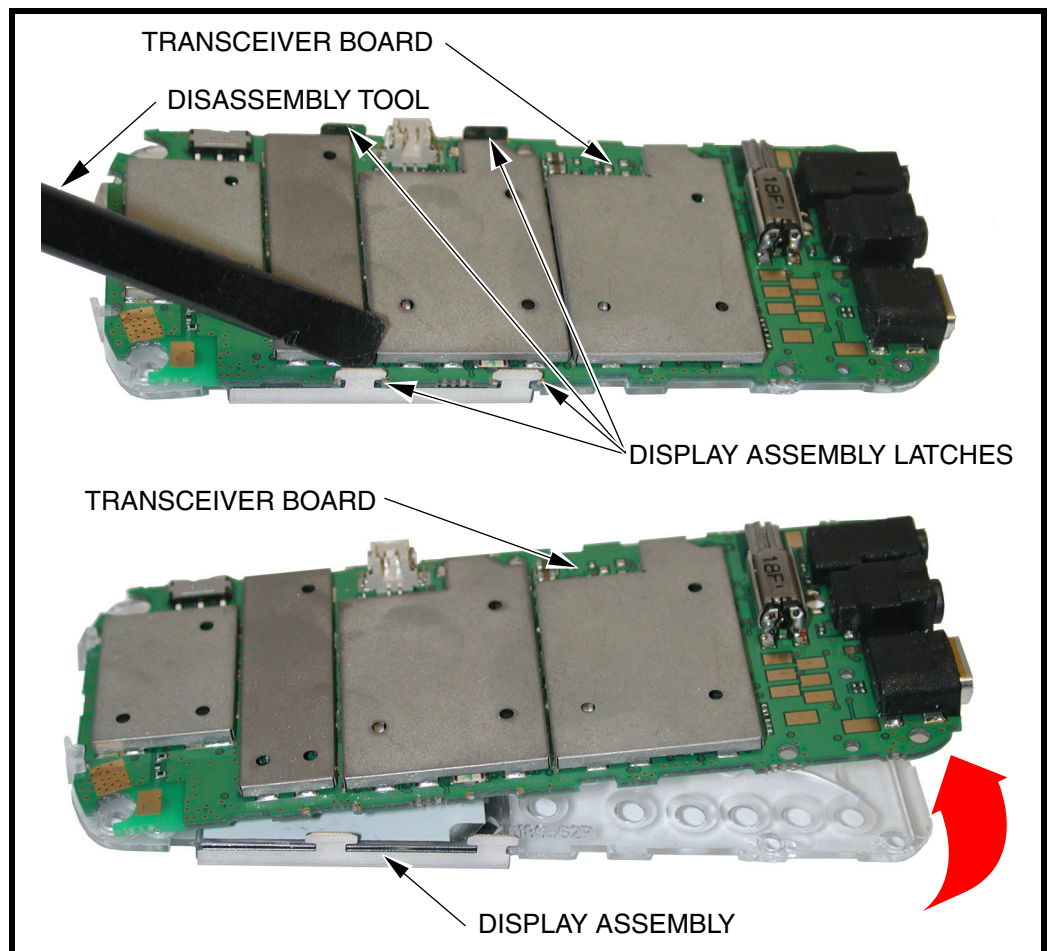

020208o

Figure 12. Removing the Transceiver Board

4. To replace, align the transceiver board with the display assembly.
5. Carefully lower the transceiver board onto the front housing.
6. Secure the 4 display assembly latches to the transceiver board.

7. Replace the display assembly, battery, front endo housing, endo assembly, SIM, and rear housing cover, as described in the procedures.

Removing and Replacing the Rear Speaker

1. Remove the rear housing cover, SIM, endo assembly, and front endo housing as described in the procedures.
2. Use the metal tweezers to gently release the 3 clips that secure the speaker.
3. Carefully pry the rear speaker out of its socket in the rear endo housing as shown in Figure 13. Avoid damage to the speaker clips.

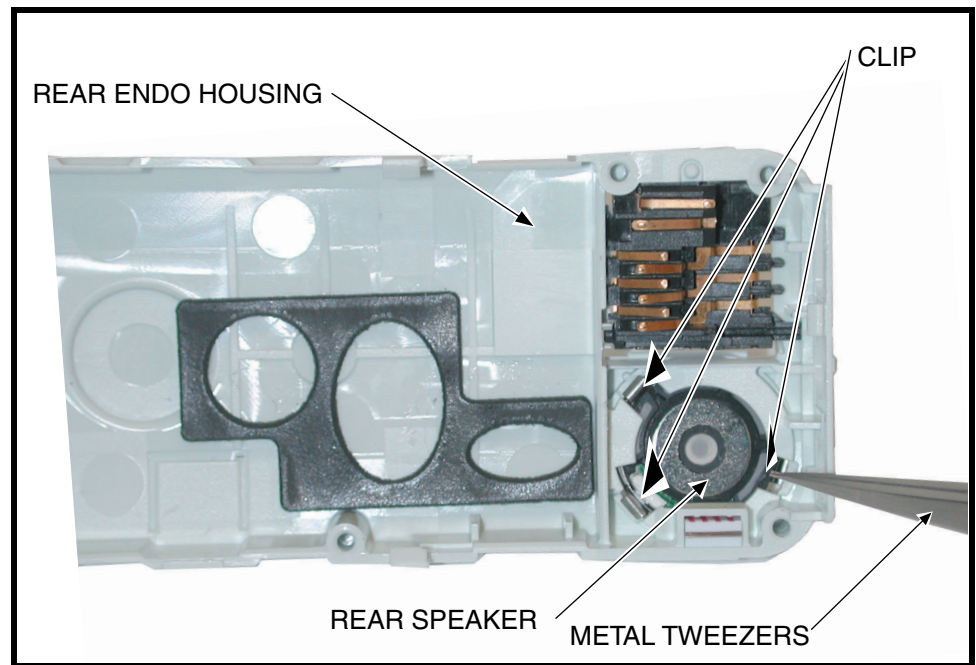

Figure 13. Removing the Rear Speaker

0201960

4. To replace, carefully press the speaker into position.
5. Ensure the speaker elastomer is seated correctly with the red bar facing up.
6. Replace the front endo housing, endo assembly, SIM, and rear housing as described in the procedures.

Removing and Replacing the Keypad

1. Remove the rear housing cover, SIM, and endo assembly as described in the procedures.
2. Use the disassembly tool to lift the keypad up and away from the front housing as shown in Figure 14.

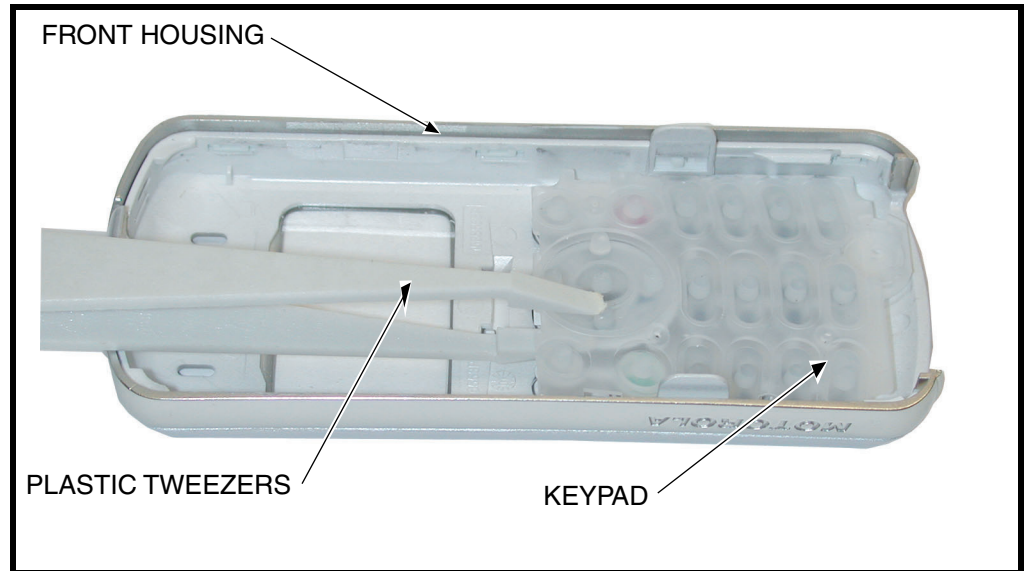

020191o

Figure 14. Removing the Keypad

3. To replace, insert the keypad into the front housing. Ensure the keys align properly with the openings and the keypad is fully seated in the front housing.
4. Replace the endo assembly, SIM, and rear housing cover, as described in the procedures.

Removing and Replacing the Front Speaker

1. Remove the rear housing cover, SIM, endo assembly, front endo housing, and battery, as described in the procedures.
2. Using the flat end of the disassembly tool to gently pry the speaker out of its socket as shown in Figure 15.
3. Be careful not to damage the speaker elastomer while removing the speaker from the front endo.
4. Lift the speaker from the front housing.

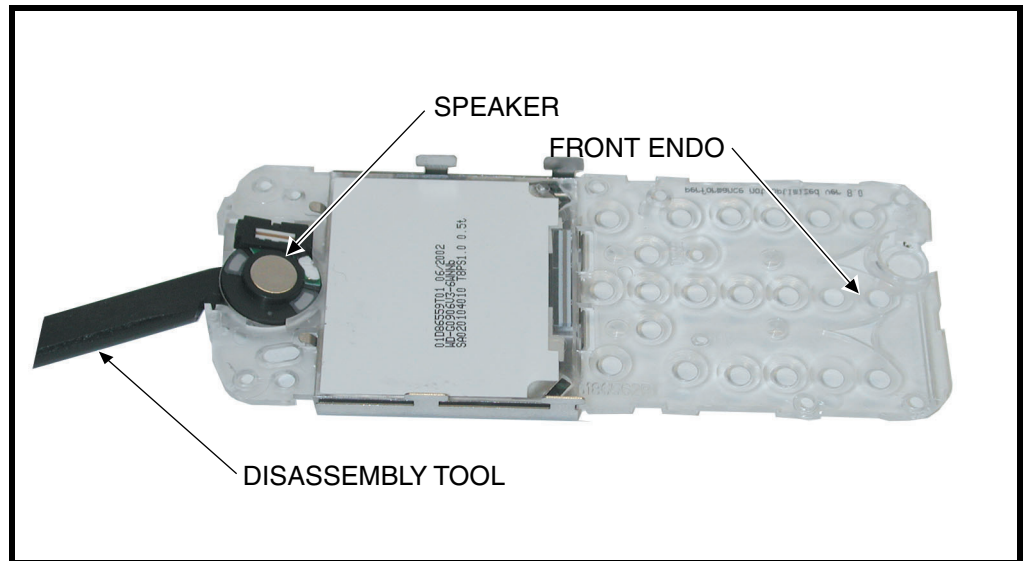

0201950

Figure 15. Removing the Front Speaker

5. To replace, align the speaker to its socket.
6. Gently press the speaker into place. Be careful not to damage the speaker elastomer when replacing the speaker.
7. Ensure the speaker elastomer is seated correctly with the red bar facing up.
8. Replace the front endo housing, endo assembly, SIM, and rear housing cover as described in the procedures.

Subscriber Identity Module (SIM) and Identification Label

SIM

A SIM is required to access the existing local GSM network, or remote networks when traveling (if a roaming agreement has been made with the provider).

The SIM card contains:

- All the data necessary to access GSM services
- The ability to store user information such as phone numbers
- All information required by the network provider to provide access to the network

Identification

Each Motorola GSM phone is labeled with a variety of identifying numbers. The following information describes the current identifying labels.

Mechanical Serial Number (MSN)

The MSN is an individual unit identity number and remains with the unit throughout its life.

The MSN can be used to log and track a phone on Motorola's Service Center Database.

The MSN is divided into 4 sections as shown in Figure 16.

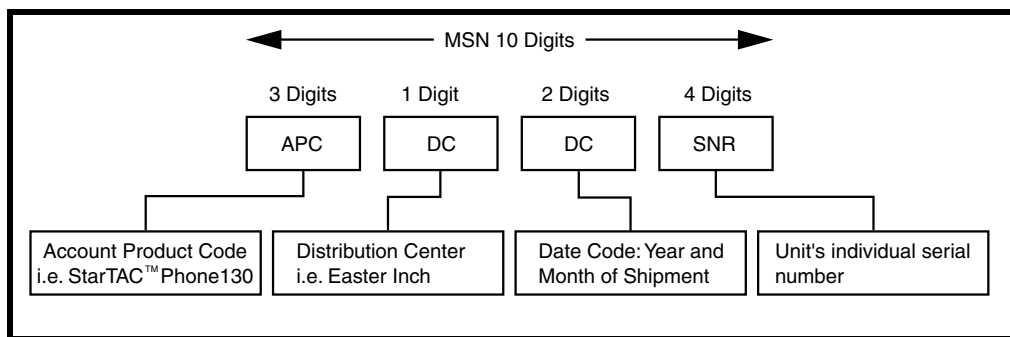

Figure 16. MSN label breakdown

000807a

International Mobile Station Equipment Identity (IMEI)

The IMEI number is an individual number unique to the PCB and is stored within the phone's memory. The IMEI number is made up of 4 sections as shown in Figure 22.

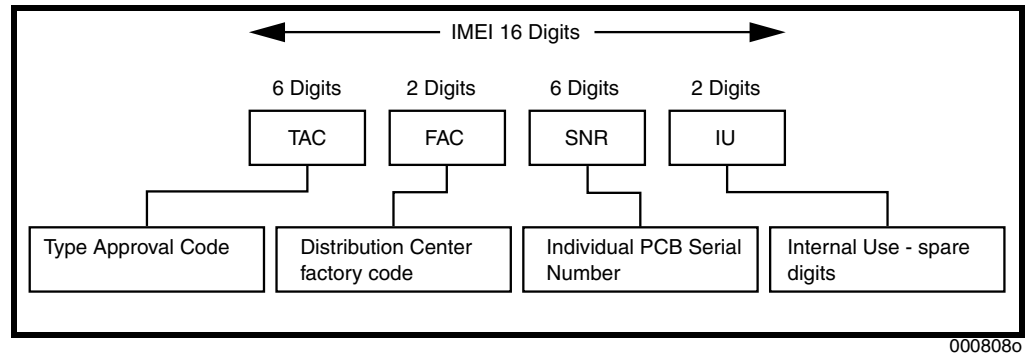

Figure 17. IMEI Label Breakdown

Other label number configurations are:

- **Transceiver Number:** Identifies the product type, Usually the SWF number. (e.g. V100).
- **Package Number:** Identifies the equipment type, mode, and language in which the phone is shipped.

Troubleshooting

Manual Test Mode

Motorola PF 0C35 telephones are equipped with a manual test mode capability. This allows service personnel to verify functionality and perform fault isolation by entering keypad commands.

To enter the manual test command mode, a GSM / DCS test SIM must be used.

1. Press **Ⓜ** to turn the phone OFF.
2. Remove the battery as described in the procedures.
3. Remove the customer's SIM card from the phone as described in the procedures.
4. Insert the test SIM into the SIM slot.
5. Replace the battery as described in the procedures.
6. Press **Ⓜ** to turn the phone ON.

Manual Test Mode Commands

Table 2. Manual Test Commands

Key Sequence	Test Function/Name	Remarks
<Menu>048263*	Enter manual test mode	
"End" Key	Exit manual test mode	
54*	Suspend	Required for all Test Mode Operations
0*0*0	Select tone 0	
0*0*1	Select tone 1	
0*0*2	Select tone 2	
0*0*3	Select tone 3	
0*0*4	Select tone 4	
0*0*5	Select tone 5	
0*0*6	Select tone 6	
0*0*7	Select tone 7	
0*0*8	Select tone 8	
0*0*9	Select tone 9	
0*0*124	Select tone 1 KHz	
0*0*125	Select tone 2 KHz	
0*0*126	Select tone 3 KHz	
0*0*127	Select tone 4 KHz	
0*1*X	Disable tone X	
3*0*1	Enable vibrator	
3*0*0	Disable vibrator	
4*3*1	Enable speech coder full rate	Audio loopback
4*3*0	Disable speech coder full rate	
4*4*1	Enable speech coder enhanced full rate	

Table 2. Manual Test Commands (Continued)

Key Sequence	Test Function/Name	Remarks
4*4*0	Disable speech coder enhanced full rate	
4*5*1	Enable speech coder half rate	
4*5*0	Disable speech coder half rate	
5*0*0	Set audio level 0	Audio level
5*0*1	Set audio level 1	
5*0*2	Set audio level 2	
5*0*3	Set audio level 3	
5*0*4	Set audio level 4	
5*0*5	Set audio level 5	
5*0*6	Set audio level 6	
5*0*7	Set audio level 7	
5*0*8	Set audio level 8	
5*0*9	Set audio level 9	
5*0*10	Set audio level 10	
5*0*11	Set audio level 11	
5*0*12	Set audio level 12	
5*0*13	Set audio level 13	
5*0*14	Set audio level 14	
5*0*15	Set audio level 15	
6*2*2*0*0	Set Audio Path. Int Mic, IntSpk, RX unmute, TX unmute	
6*4*6*0*0	Set Audio Path. Boom Mic, Boom Spk, RX unmute, TX unmute	
10*0*3	Set band GSM 900	
10*0*4	Set band DCS 1800	
10*0*5	Set band PCS 1900	
10*0*6	Set dual band GSM 900 / 1800	
10*1*0	Read band	3= GSM 4= DCS 5= PCS 6 =GSM/DCS
18*0	Initialize non-volatile memory (Master Reset)	
18*1	Initialize Non-volatile memory (Master Clear)	
20*X*0	Load Channel number X	Select Channel (Used for debugging Rx mode)
20*1*0	Load channel number 1 GSM Low channel	
20*62*0	Load channel number 62 GSM Mid channel	
20*124*0	Load channel number 124 GSM High channel	
20*512*0	Load channel number 512 DCS Low channel	
20*700*0	Load channel number 700 DCS Mid channel	
20*885*0	Load channel number 885 CDS High channel	
20*512*0	Load channel number 512 PCS Low channel	
20*661*0	Load channel number 661 PCS Mid channel	
20*810*0	Load channel number 810 PCS High channel	
55*2*001	Test Display. All pixels ON	
55*2*000	Test Display. All pixels OFF	
55*2*002	Test Display. Checkerboard pattern A	

Table 2. Manual Test Commands (Continued)

Key Sequence	Test Function/Name	Remarks
55*2*003	Test Display. Checkerboard pattern B	
55*2*004	Test Display. Border pixels ON	
*#06#	IMEI Check	No Test Mode Required
Phone Set up --> Phone Status --> Other Information	Flex Version / Technology / S-W Version / Readiness Status	No Test Mode Required

Troubleshooting Chart

Table 3. PF 0C35 Telephone: Level 1 and 2 Troubleshooting Chart

Symptom	Probable Cause	Verification And Remedy
1. Telephone will not turn on or stay on.	a) Battery either discharged or defective.	Measure the voltage at TP_BATT+ with battery attached. If voltage is below 3.0V, attach a charger to the phone and ensure that the phone is charging. If the phone does not charge, change the battery and repeat the measurement charging procedure. If the phone still does not turn on, proceed to b).
	b) Battery connector P800 opened or misaligned.	Inspect battery connector P800 for any mechanical failure. Apply short/open circuit test using multi-meter if appropriate. If battery connector is OK, proceed to c).
	c) Transceiver board defective.	Replace the faulty board with a known good transceiver board. If the phone powers up after replacement, reassemble the phone with a new transceiver board. Verify that the fault is fixed.
2. Telephone exhibits poor reception or erratic operation such as calls frequently dropping or weak or distorted audio.	a) Antenna defective	Check connection between the antenna and the transceiver board. If the contact is intermittent visually, replace with a known good back Endo. If the fault is still present, proceed to b).
	b) Transceiver board defective.	Replace with a known good transceiver board (refer to 1c). Verify that the fault has been cleared with the new transceiver board and reassemble the unit.
3. Display is erratic, or provides partial or no display.	a) Elastomeric connections between transceiver and front Endo faulty.	Replace the front Endo with a known good one. If display still does not come up, proceed to b).
	b) Transceiver board defective.	Replace with a known good transceiver board (refer to 1c). Verify that the fault has been cleared with the new transceiver board and reassemble the unit.
4. Incoming call alert transducer audio distorted or volume is too low.	a) Faulty back Endo.	Replace the back Endo with a known good back Endo. If the problem goes away, replace with a new back Endo. Else proceed to b).
	b) Transceiver board defective	Replace with a known good transceiver board (refer to 1c). Verify that the fault has been cleared with a new transceiver board.
5. Telephone transmit audio is weak. (usually indicated by called parties complaining of difficulty in hearing voice).	a) Microphone defective on the front Endo.	Replace the microphone or the front Endo as described in the procedures. If fault is not cleared, proceed to b).

Table 3. PF 0C35 Telephone: Level 1 and 2 Troubleshooting Chart (Continued)

Symptom	Probable Cause	Verification And Remedy
	b) Transceiver board defective.	Replace the transceiver board (refer to 1c). Verify that the fault has been cleared and reassemble the unit with the new transceiver board.
6. Receive audio from earpiece speaker is weak or distorted.	a) Elastomeric connections between front Endo earpiece speaker and transceiver board faulty.	Replace the front Endo with a known good one. Reassemble with a new front Endo if the fault goes away. If the fault is still present, proceed to b.
	b) Transceiver board defective.	Replace the transceiver board (refer to 1c). Verify that the fault has been cleared and reassemble the unit with the new transceiver board.
7. Telephone will not recognize or accept SIM card.	a) SIM card defective.	Check the SIM card contacts for dirt. Clean if necessary, and check if fault has been cleared. If the contacts are clean, insert a known good SIM card into the telephone. Power up the unit and confirm that the card has been accepted. If the fault goes away, replace the defective SIM card. If the SIM card is not at fault, proceed to b.
	b) Pressure contact between SIM block on back Endo and transceiver board defective.	Replace the back Endo with a known good one. If problem goes away, replace with a new back Endo and reassemble. Else proceed to c.
	c) Transceiver board defective.	Replace the transceiver board (refer to 1c). Verify that the fault has been cleared and reassemble the phone with the new transceiver board.
8. Vibrator feature not functioning.	Transceiver board defective.	Replace the transceiver board with a known good transceiver board (refer to 1c). Verify that the fault has been cleared and reassemble the unit with the new transceiver board.
9. Internal Charger not working.	Transceiver board defective.	Replace the transceiver board with a known good transceiver board (refer to 1c). Verify that the fault has been cleared and reassemble the unit with the new transceiver board.
10. No or weak audio when using headset.	a) Headset plug not pushed in fully.	Ensure the headset plug is fully seated in the jack.
	b) Faulty jack on transceiver board.	Replace the transceiver board with a known good transceiver board (refer to 1c). Verify that the fault has been cleared and reassemble the unit with the new transceiver board.

Programming: Software Upgrade and Flexing

Contact your local technical support engineer for information about equipment and procedures for flashing and flexing.

Part Number Charts

The following section provides a reference for the parts associated with PF 0C35 telephones.

Related Publications

Motorola C330 Wireless Phone User Guide (English)

Exploded View Parts List

Table 4. Exploded View Parts List

Item Number	Motorola Part Number	Description
1	6186557P02	Display Lens
2	1370316B14	Decal
3	See Table 6	Front Housing
4	1586552P01	Center Band
5		
6	7586586P01	Keypad
7	4086548P01	Mylar metal domes
8	0109047A53	Transceiver Board Assembly
9		
10		
11		
12		
13		
14	See Table 6	Back Housing
15	0309315B07	Screw (6)
16	0786561P01	LCD Bracket

Item Number	Motorola Part Number	Description
17		
18	7204615R01	LCD Display Assembly
19	0186559P02	Front Endo Housing Assembly
20		
21	5089081L01	13 mm Audio Speaker
22		
23		
24		
25	5088625L01	Microphone
26		
27	0104119F84	Back Endo Housing Assembly
28		Antenna
29		
30	5004607R01	15 mm MIDI Speaker Assembly
31	0104119F93	15 mm MIDI Speaker Holder Assembly
*	0189727L01	Battery

Notes:



There is a danger of explosion if the Lithium ion battery pack is replaced incorrectly. Replace only with the same type of battery or equivalent as recommended by the battery manufacturer. Dispose of used batteries according to the manufacturer's instructions.

To order parts please use the following Link:

https://wissc.motorola.com/wissc_root/main/BrowserOK.html

(Password is Required)

For information on ordering parts please contact EMEA at +44 131 479 1274.

Model-Specific Part Numbers

Table 5. Model-Specific Part Numbers

Item Number	Part Description	Part Number
3	Assembly, Front housing, Frosted Silver	0186558P02
3	Assembly, Front Housing, Misty Blue	0186558P03
3	Assembly, Front Housing, Indigo	0186558P04
3	Assembly, Front Housing, Dark Pearl Blue	0186558P05
14	Rear Housing, Frosted Silver	1586556P02
14	Rear Housing, Misty Blue	1586556P03
14	Rear Housing, Dreamy Aqua	1586556P04
14	Rear Housing, Dark Pearl Blue	1586556P05
	Battery, English	AANN4136A
	Battery, Chinese	AANN4137A

Accessories

Table 6. List of Accessories

Description	Part Number
Travel Charger, US	SPN4681
Travel Charger, UK	SPN4680
Travel Charger, PRC	SPN4677
Emergency Battery Charger	SPN5026
Easy Install Car Kit	SYN8543
Optional External Mic	SYN5708B
Vehicle Power Adapter	SYN8087
FreeCharge Emergency Power Source	SPN4999
Headset, Retractable	SYN8284
Headset, 2nd Generation, Retractable	SYN9050
Headset, Over the ear	SYN8908
Neck loop	SYN7875
Headset, One touch	SYN8419
Headset, Universal Customizable	SYN9350

Index

A

alert settings 12
antenna, removing and replacing 26

B

battery
 charge indicator 13
 function 13
battery, removing and replacing 20

C

caller ID 9
Canadian Interference-Causing Equipment regulations 1
changes
 product 1
commands, manual test mode 35
copyrights
 computer software 2

D

disassembly 20
display assembly, removing and replacing 27

E

endo housing, removing and replacing 23
exploded view diagram 40
exploded view parts list 41

F

FCC rules 1
features
 caller ID 9
 chat messaging 9
 SIM Toolkit 9
 text entry 9
 voice recognition 8
 Wireless Access Protocol (WAP) 8
front endo housing, removing and replacing 24
front speaker, removing and replacing 32

H

housing cover rear, removing and replacing 23

I

identification
 international mobile station equipment identity 34
 mechanical serial number 33
 product 1
identification, labels 33
IMEI 34
Introduction 1

K

keypad, removing and replacing 31

L

LCD 10
liquid crystal display (LCD) 10

M

manual test mode 35
menu structure 12
microphone, removing and replacing 28
model-specific part numbers 42
MSN 33

N

names
 product 1

O

operation 10
 alert settings 12
 battery 13
 controls, indicators, and I/O connectors 10
 icons 11
 alarm 11
 battery charge indicator 11
 home zone 11
 message 11
 real time clock 11
 ringer 11
 roam 11
 service 11
 signal strength 11
 voicemail 11
 LCD 10
 menu navigation 10
 menu structure 12
overview, product 7

P

parts

- exploded view diagram 40
- exploded view parts list 41
- model-specific part numbers 42
- replacement parts 39

product

- changes 1
- identification 1
- names 1

product overview 7

- features 7

publications, related 39

R

Rear housing cover, removing and replacing 20

rear speaker, removing and replacing 30

regulatory agency compliance 1

related publications 39

removing

- antenna 26
- battery 13, 20
- display assembly 27
- endo housing 23
- front endo housing 24
- front speaker 32
- keypad 31
- microhpone 28
- rear housing cover 20, 23
- rear speaker 30
- SIM 22
- transceiver board 28, 29

replacement parts

- ordering 4

replacing

- antenna 26
- battery 20
- display assembly 27
- endo housing 23
- front endo housing 24
- front speaker 32
- keypad 31
- microphone 28
- rear housing cover 20, 23
- rear speaker 30
- SIM 22
- transceiver board 28, 29

revisions

- service manual 3

S

serial number

- mechanical 33

service manual

- about 2
- audience 2
- conventions 3
- revisions 3
- scope 2

service policy 3

- customer support 4
- out of box failure 3
- product support 3

shut down

- upon battery removal 13

SIM Toolkit 9

SIM, description 33

SIM, removing and replacing 22

specifications 5

subscriber identity module (SIM) 33

support

- customer 4
- product 3

T

test equipment 19

text entry 9

tools, disassembly 19

transceiver board, removing and replacing 28, 29

troubleshooting 35

- manual test mode 35
- manual test mode commands 35
- troubleshooting chart 37

V

voice recognition 8

W

WAP (Wireless Access Protocol) 8

warranty service 3

MOTOROLA, the Stylized M Logo, and all other trademarks indicated as such herein are trademarks of Motorola, Inc
Truesync is a trademark of Starfish Software, Inc..

® Reg. U.S. Pat. & Tm. Off.

© 2002 Motorola, Inc.

All rights reserved.

Personal Communications Sector,

1500 Gateway Blvd.

Boynton Beach, FL 33426-8292



6881040B65-O

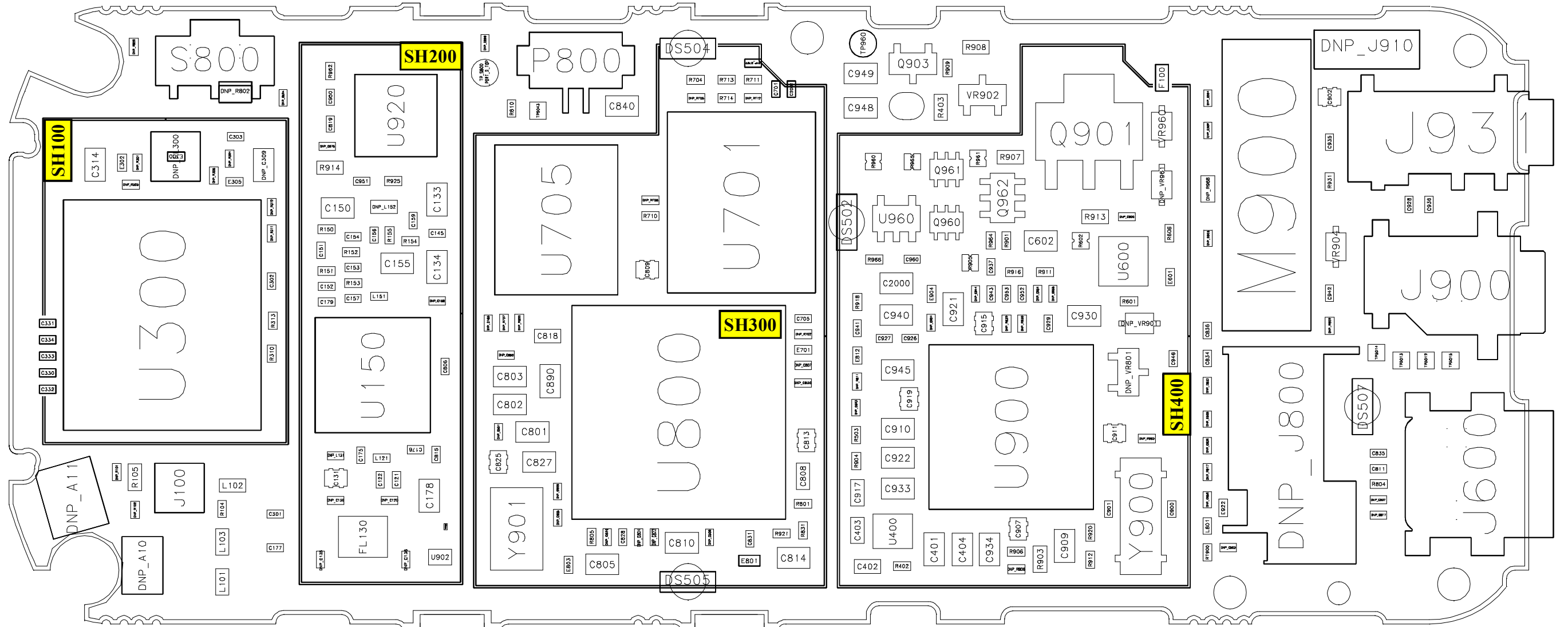

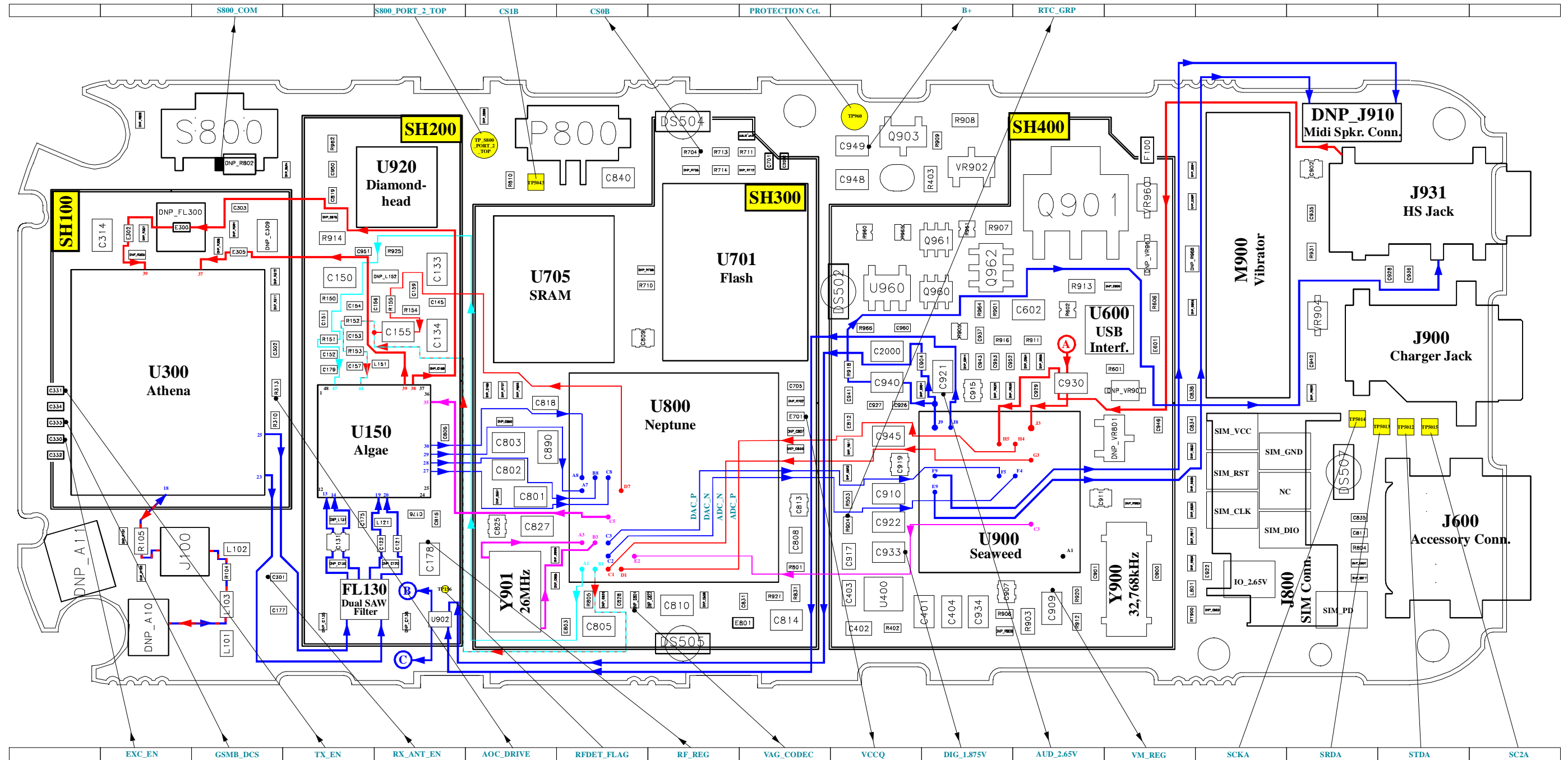

- (A) TX MIC LINE
- (B) RX SPEAKER LINE (SPK1)
- (C) RX SPEAKER LINE (SPK2)

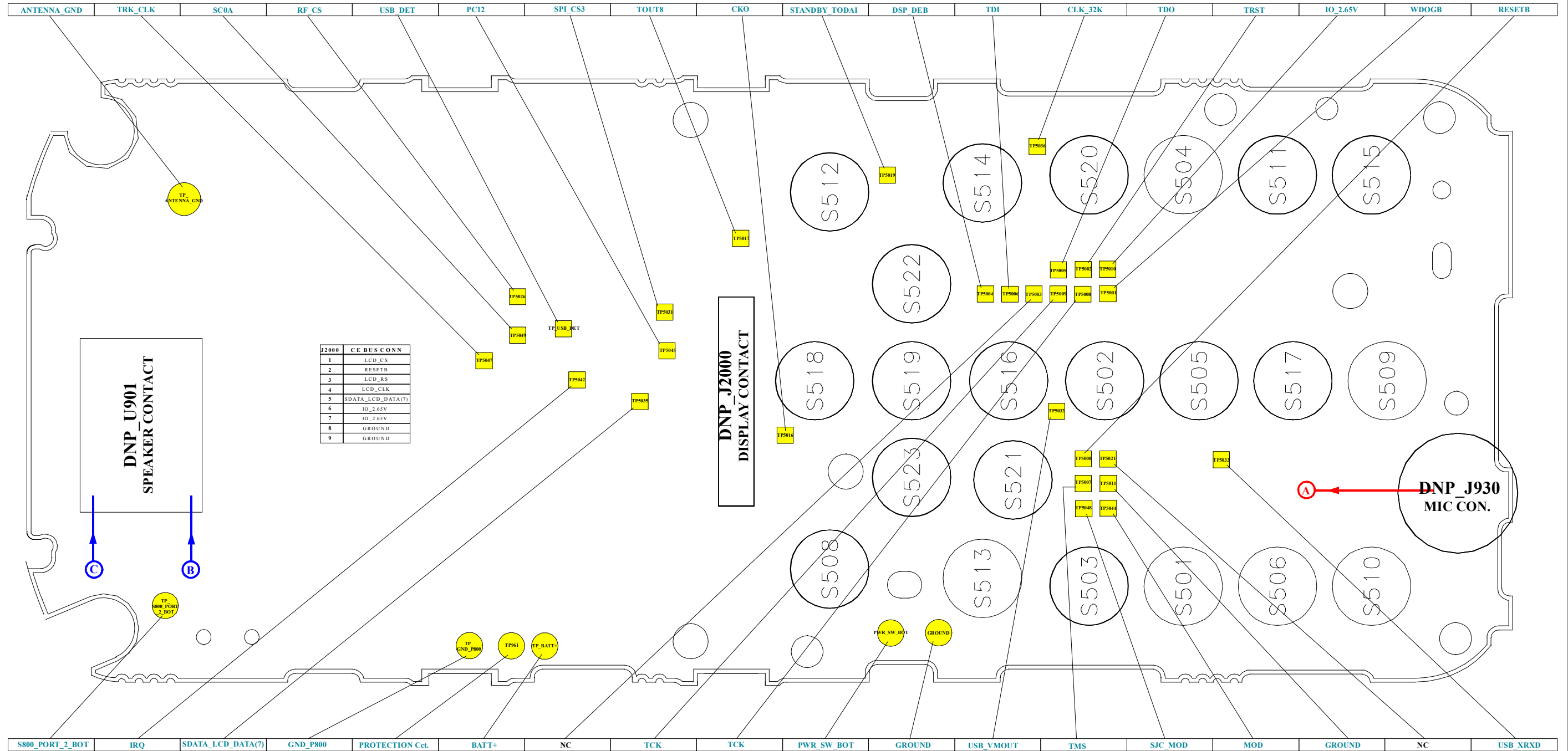

J2000	CE BUS CONN
1	LCD_CS
2	RESETB
3	LCD_RS
4	LCD_CLK
5	SDATA_LCD_DATA(7)
6	IO_2.65V
7	IO_2.65V
8	GROUND
9	GROUND

- (A) TX MIC LINE
- (B) RX SPEAKER LINE (SPK1)
- (C) RX SPEAKER LINE (SPK2)